

SISTEMAS DE CARPINTERIA

Standard

LISTADO DE PERFILES

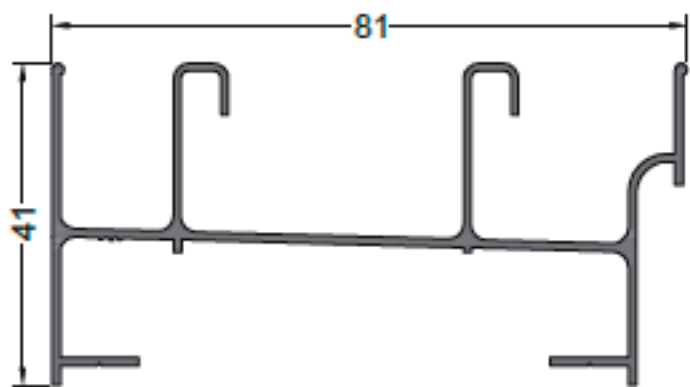

17901
0.673 Kg/m

CORREDIZA MARCO

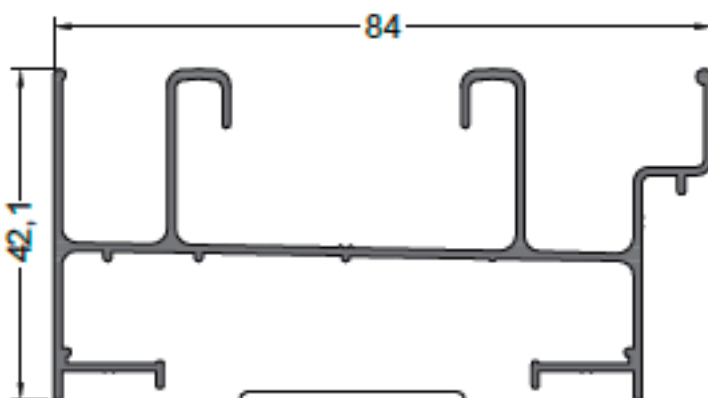

99901
0.764 Kg/m

CORREDIZA MARCO

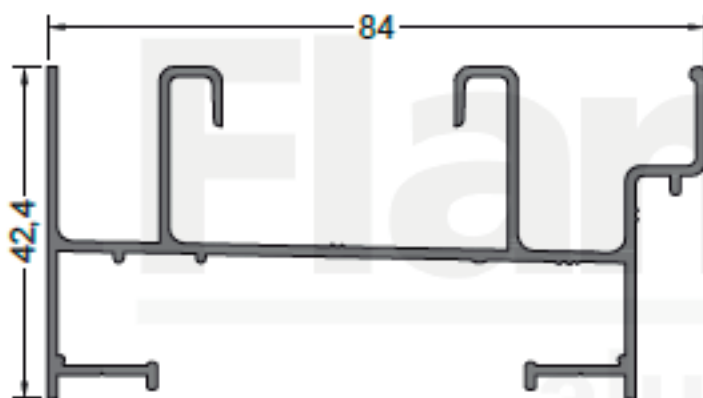

99001
0.926 Kg/m

CORREDIZA MARCO

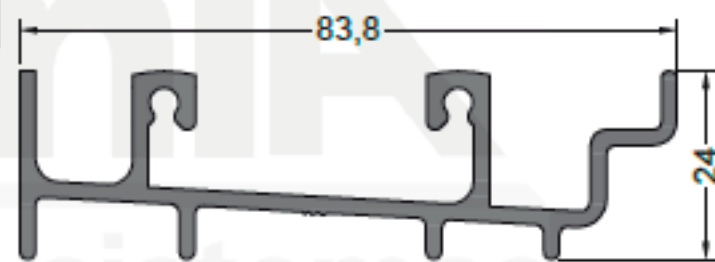

99017
1.072 Kg/m

CORREDIZA MARCO UMBRAL

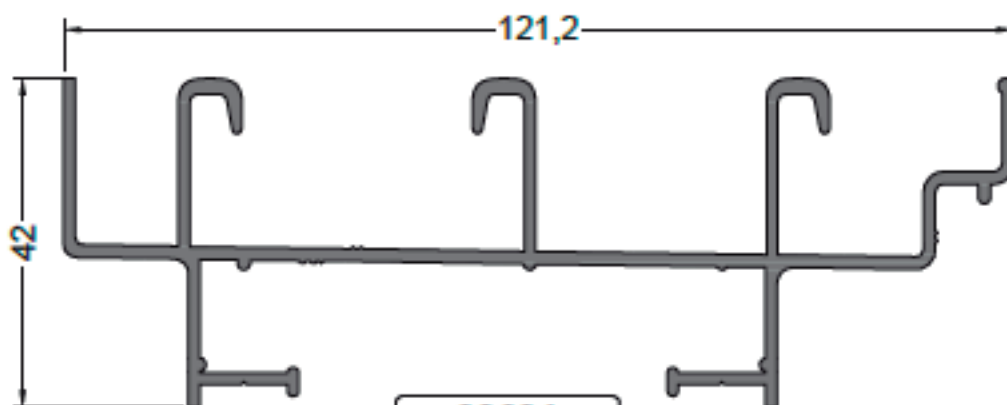

99691
1.369 Kg/m

CORREDIZA MARCO
3 GUIAS

NOTA: LOS PESOS INDICADOS SON ESTIMADOS.

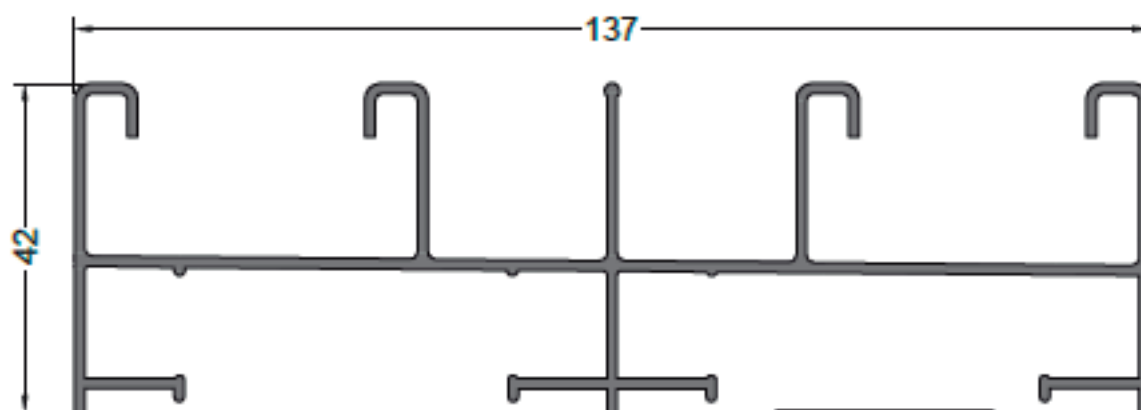

99714
1.409 Kg/m

**CORREDIZA MARCO
4 GUIAS**

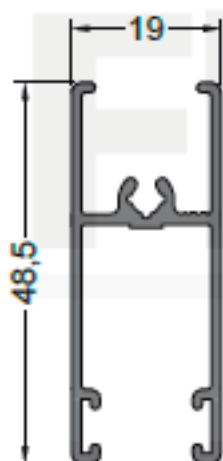

12002
0.466 Kg/m

**CORREDIZA HOJA
DINTEL**

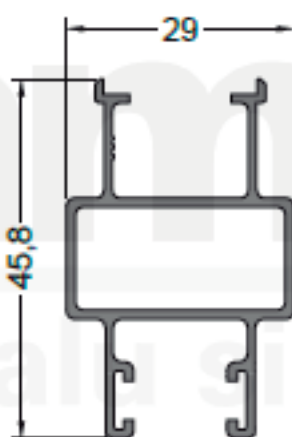

12003
0.489 Kg/m

**CORREDIZA HOJA
JAMBA**

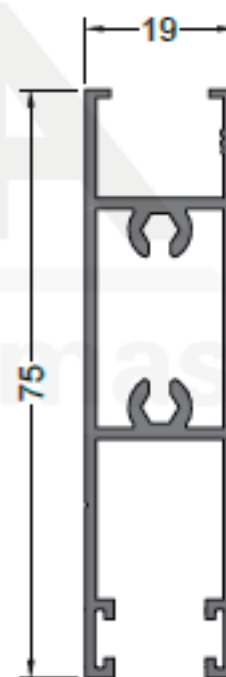

99044
0.871 Kg/m

**CORREDIZA HOJA
UMBRAL**

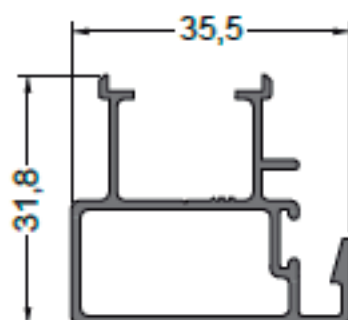

12004
0.448 Kg/m

**CORREDIZA HOJA
ENCUENTRO**

NOTA: LOS PESOS INDICADOS SON ESTIMADOS.

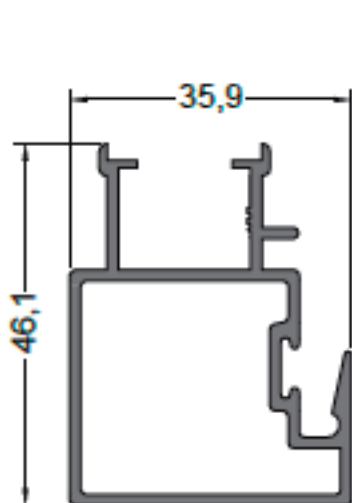

99054
0.700 Kg/m
CORREDIZA HOJA
ENCUENTRO

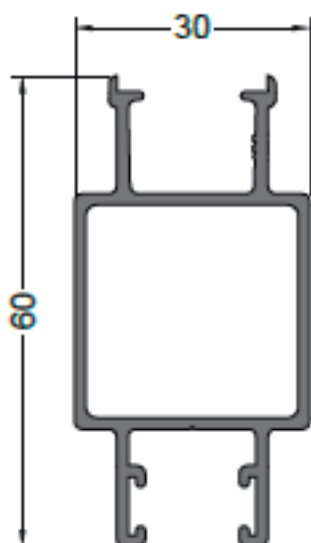

99053
0.712 Kg/m
CORREDIZA HOJA
JAMBA

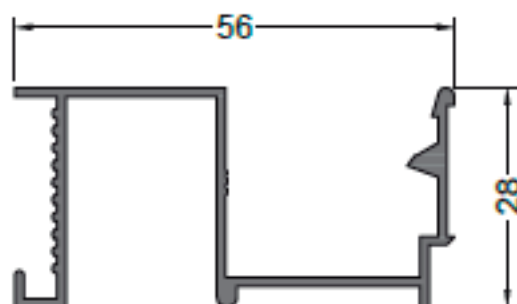

99020
0.500 Kg/m
CORTINA GUIA
COMUN 56 mm.

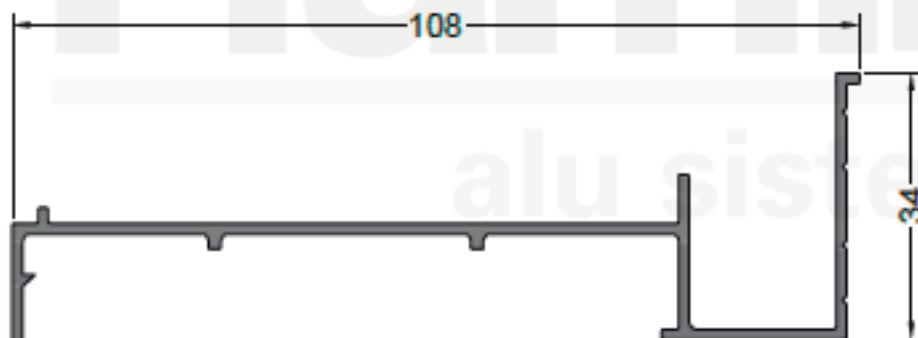

10318
0.623 Kg/m
CORTINA GUIA
REGULABLE 108 mm.

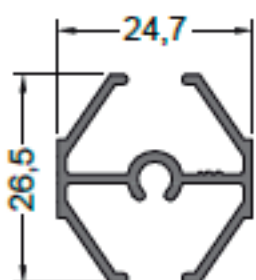

12232
0.309 Kg/m
VIDRIO REPARTIDO
NUCLEO

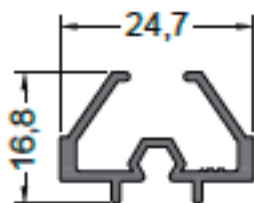

12249
0.232 Kg/m
VIDRIO REPARTIDO
PERIMETRAL

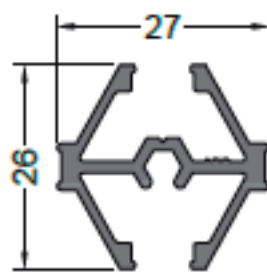

11197
0.386 Kg/m
VIDRIO REPARTIDO
NUCLEO

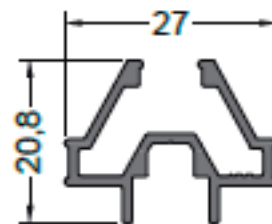

11198
0.293 Kg/m
VIDRIO REPARTIDO
PERIMETRAL

NOTA: LOS PESOS INDICADOS SON ESTIMADOS.

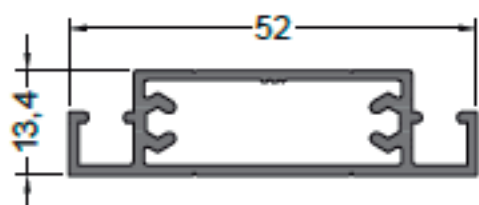

11241
0.506 Kg/m

**CORREDIZA MOSQUITERO
TRAVESAÑO**

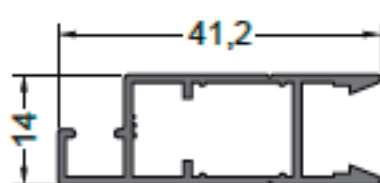

12005
0.322 Kg/m

**CORREDIZA MOSQUITERO
HOJA**

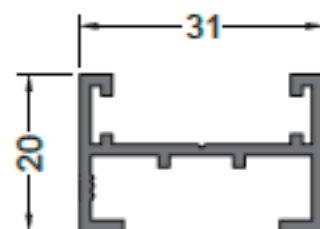

17060
0.341 Kg/m

**CORREDIZA ENCUESTRO
4 HOJAS**

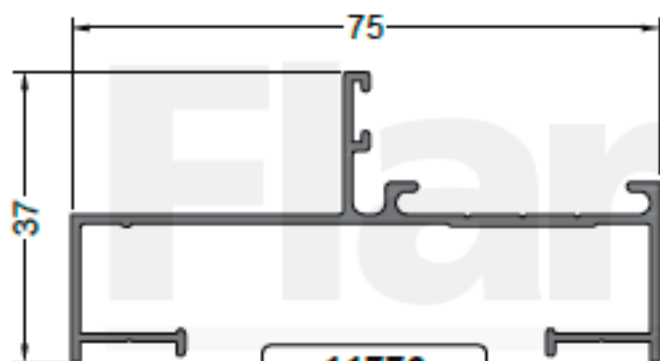

11776
0.565 Kg/m

**PUERTA MARCO
ENCOLIZADO**

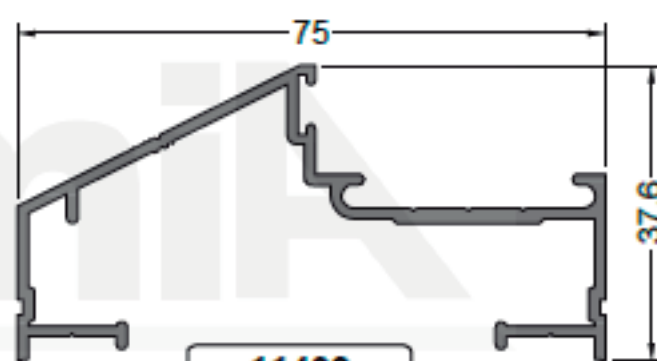

11403
0.710 Kg/m

**PUERTA MARCO
ENCOLIZADO**

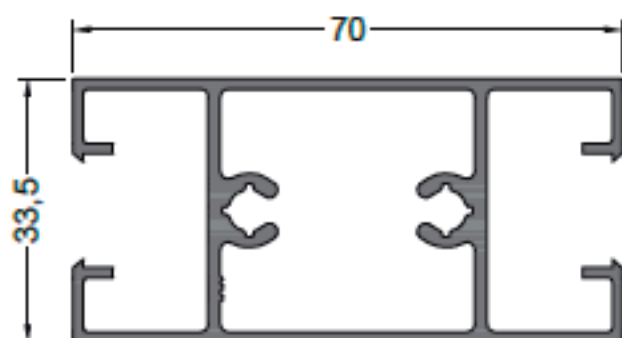

11578
1.080 Kg/m

**PUERTA HOJA
UMBRAL/DINTEL/TRAVESAÑO**

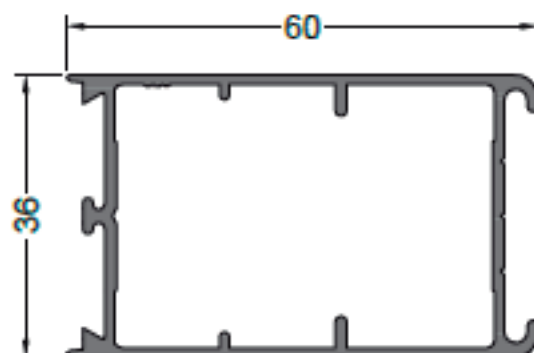

11577
0.750 Kg/m

**PUERTA HOJA
PARANTE**

NOTA: LOS PESOS INDICADOS SON ESTIMADOS.

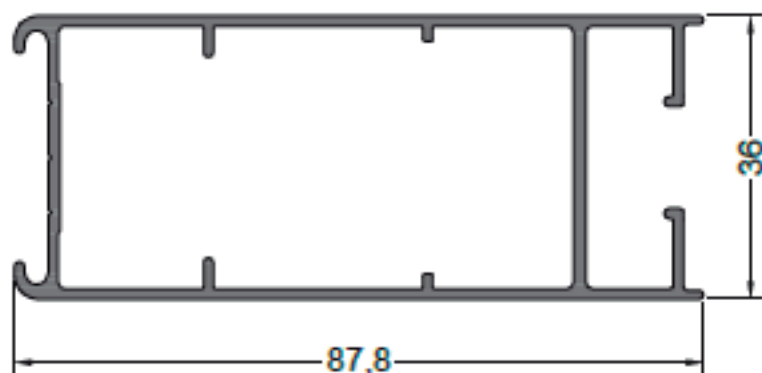

14030
0.972 Kg/m
PUERTA HOJA
PARANTE C/CONTRAVIDRIO

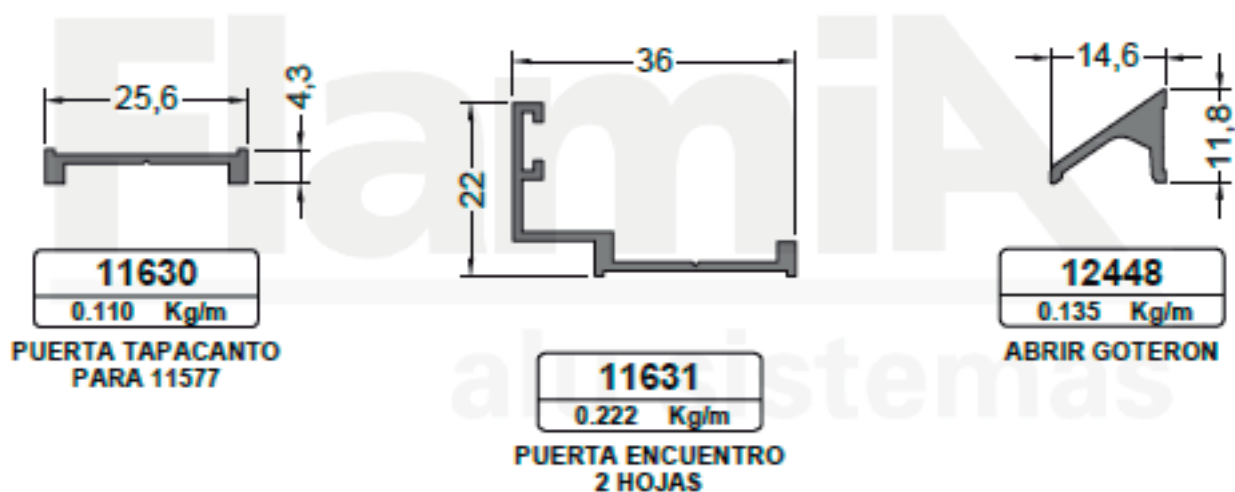

11630
0.110 Kg/m
PUERTA TAPACANTO
PARA 11577

11631
0.222 Kg/m
PUERTA ENCUENTRO
2 HOJAS

12448
0.135 Kg/m
ABRIR GOTERON

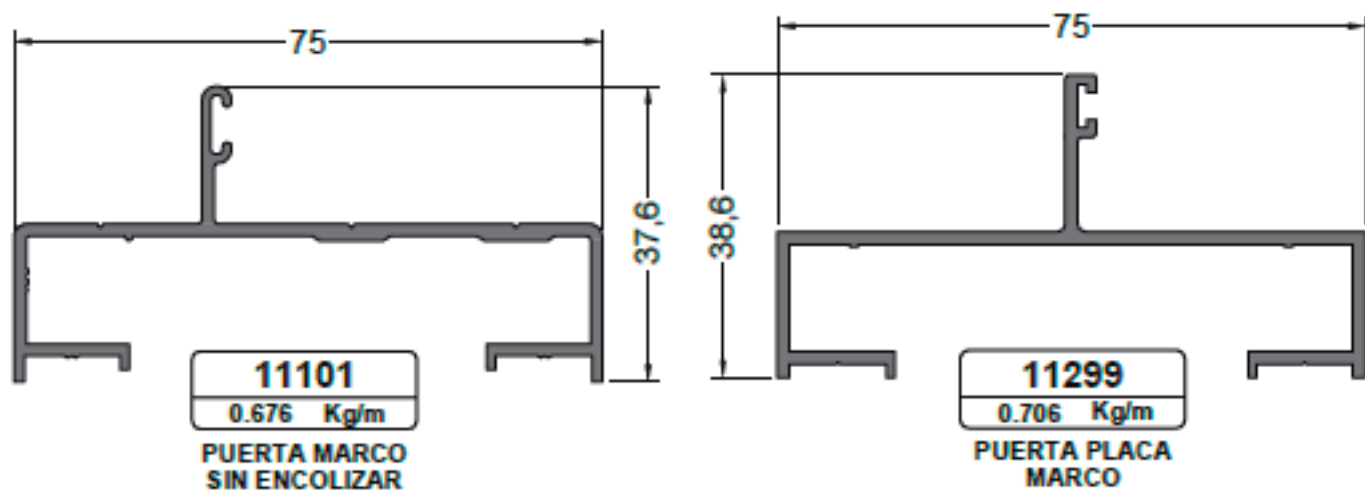

11101
0.676 Kg/m
PUERTA MARCO
SIN ENCOLIZAR

11299
0.706 Kg/m
PUERTA PLACA
MARCO

NOTA: LOS PESOS INDICADOS SON ESTIMADOS.

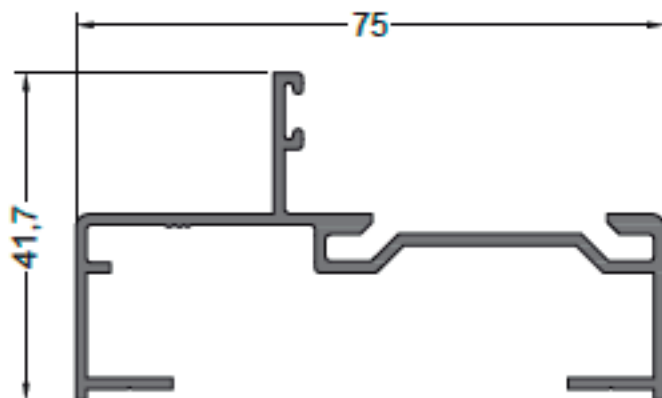

11253
0.715 Kg/m
PUERTA MARCO
ENCOLIZADO



11252
1.015 Kg/m
PUERTA HOJA
ENCOLIZADA

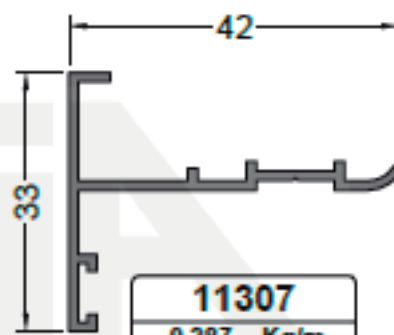

11307
0.287 Kg/m
PUERTA BATIENTE
PARA 11252

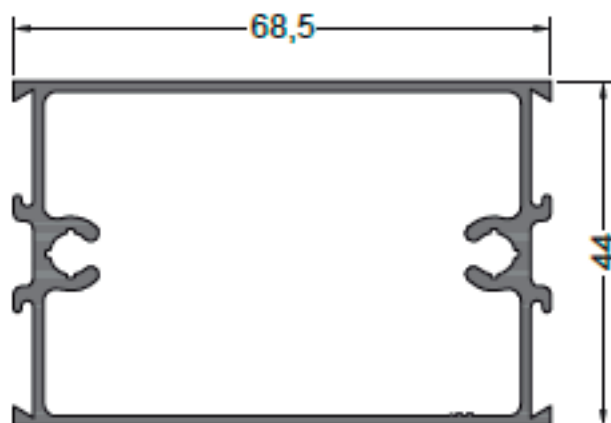

11256
1.040 Kg/m
PUERTA HOJA
UMBRAL/DINTEL/TRAVESAÑO

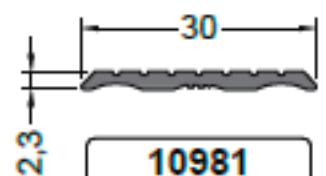

10981
0.144 Kg/m
PUERTA TAPACANTO

NOTA: LOS PESOS INDICADOS SON ESTIMADOS.

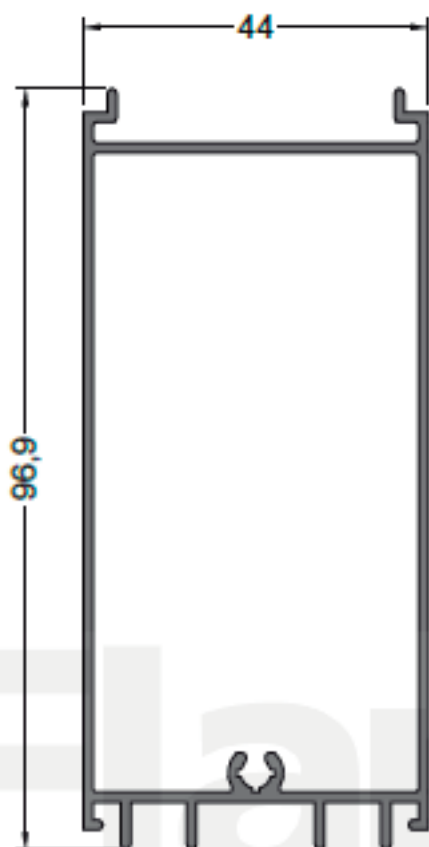

11686
1.030 Kg/m
PUERTA REVESTIMIENTO
TUBULAR 97 mm.

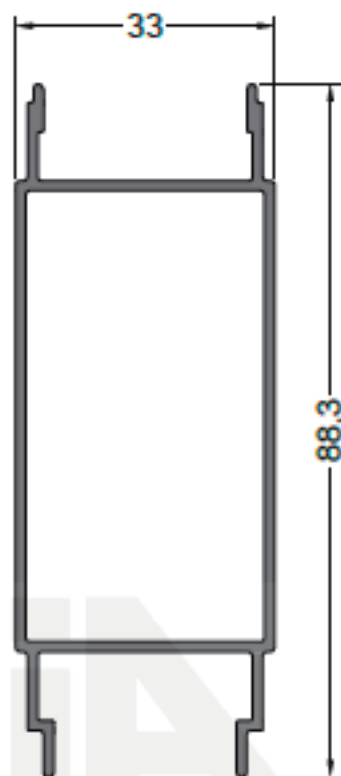

12672
0.835 Kg/m
PUERTA REVESTIMIENTO
TUBULAR 88 mm.

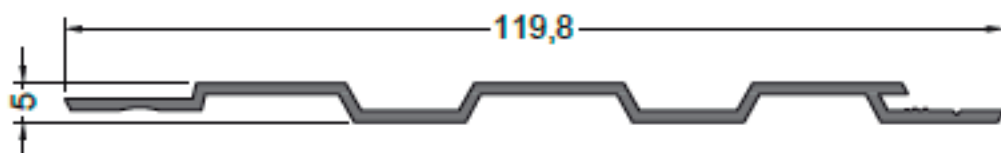

11306
0.505 Kg/m
REVESTIMIENTO
120 mm.

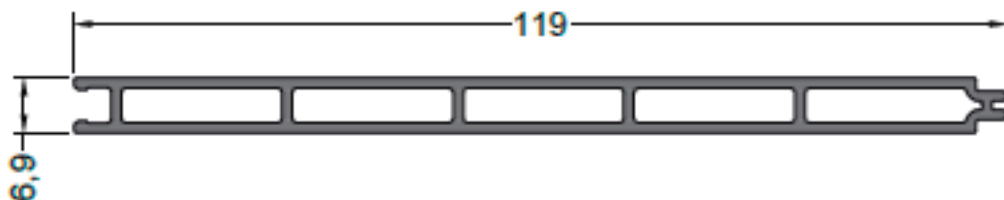

14288
0.891 Kg/m
REVESTIMIENTO
TUBULAR 119 mm.

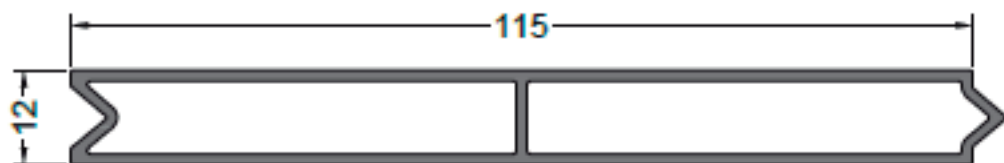

14119
0.936 Kg/m
REVESTIMIENTO
TUBULAR 115 mm.

NOTA: LOS PESOS INDICADOS SON ESTIMADOS.

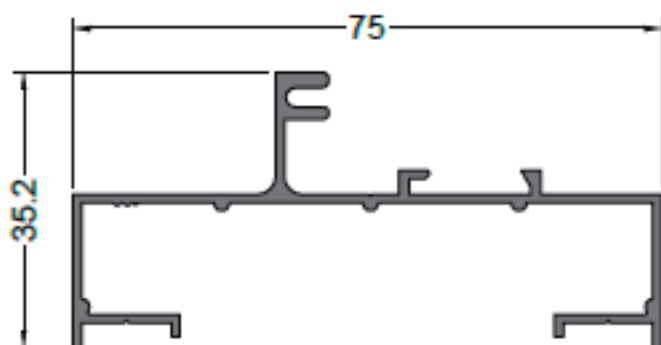

99907
0.558 Kg/m
PAÑO FIJO MARCO

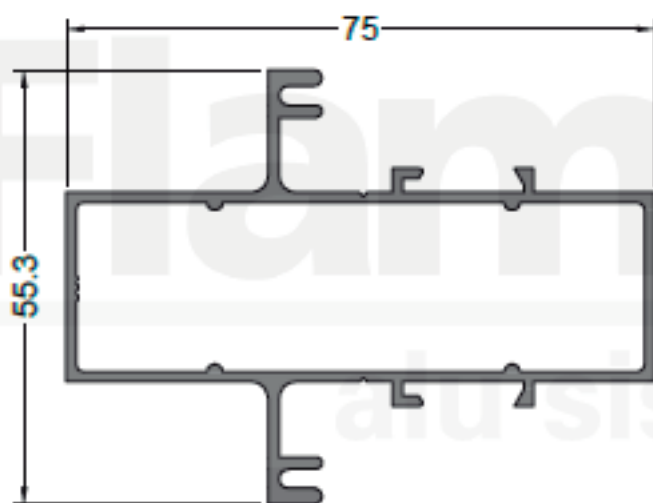

99094
0.978 Kg/m
PAÑO FIJO TRAVESAÑO

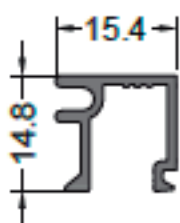

99008
0.165 Kg/m
CONTRAVIDRIO 15.4 mm.

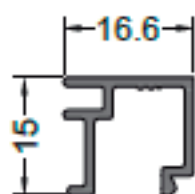

17006
0.170 Kg/m
CONTRAVIDRIO 16.6 mm.

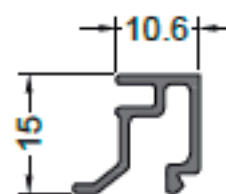

11746
0.157 Kg/m
CONTRAVIDRIO 10 mm.

NOTA: LOS PESOS INDICADOS SON ESTIMADOS.

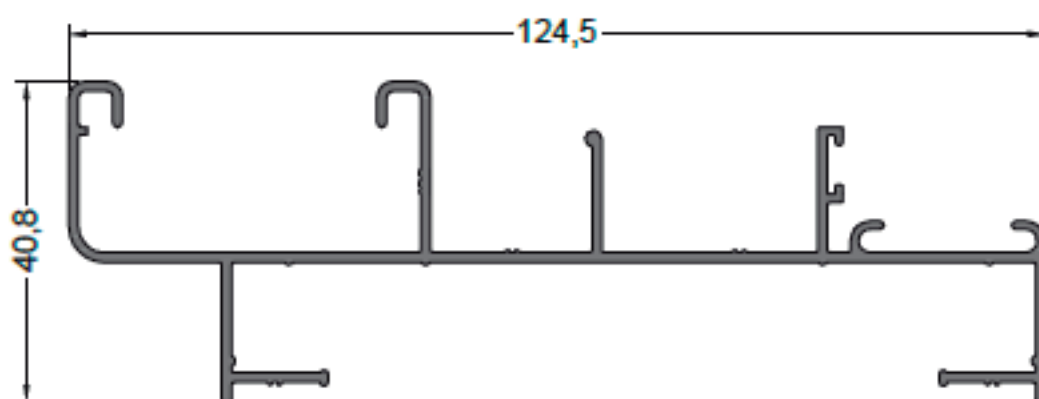

12151
0.966 Kg/m
CORREDIZA MARCO
C/POSTIGON

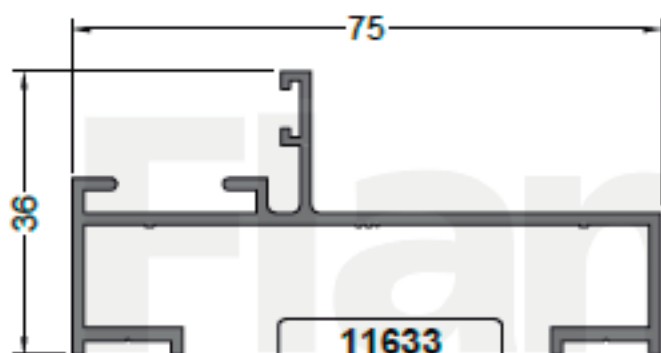

11633
0.601 Kg/m
POSTIGON
MARCO

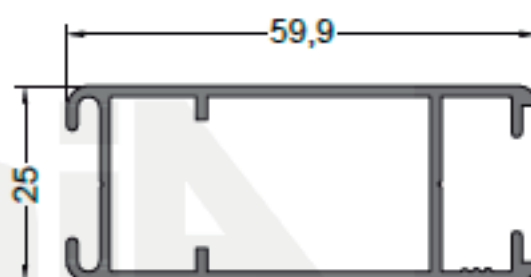

12204
0.668 Kg/m
POSTIGON HOJA
60 mm.

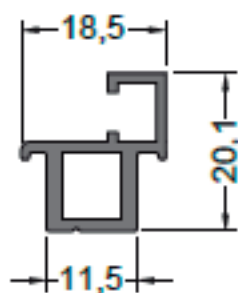

13332
0.273 Kg/m
MOSQUITERO POSTIZO

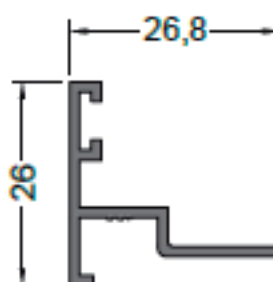

11632
0.223 Kg/m
POSTIGON ENCUENTRO
2 HOJAS

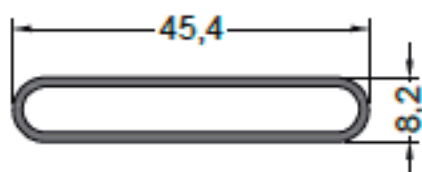

10992
0.300 Kg/m
POSTIGON TABLILLA
TUBULAR

NOTA: LOS PESOS INDICADOS SON ESTIMADOS.

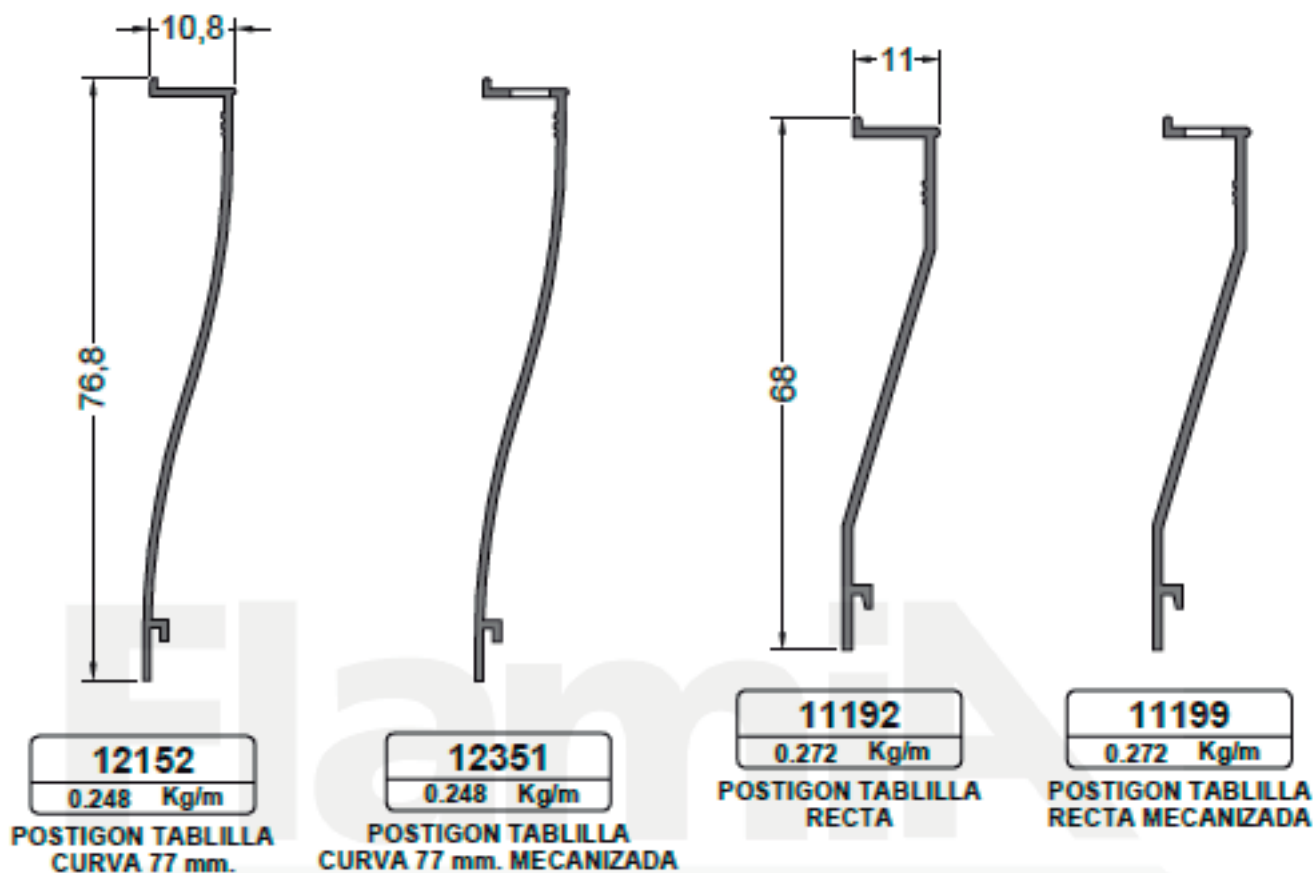

alu sistemas

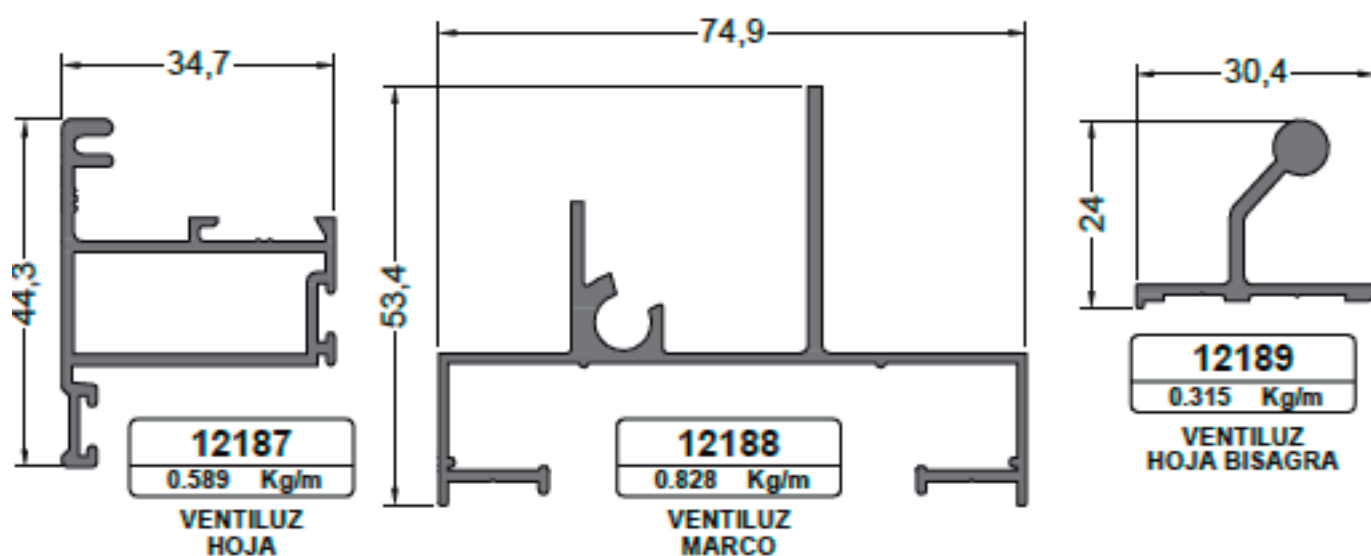

NOTA: LOS PESOS INDICADOS SON ESTIMADOS.

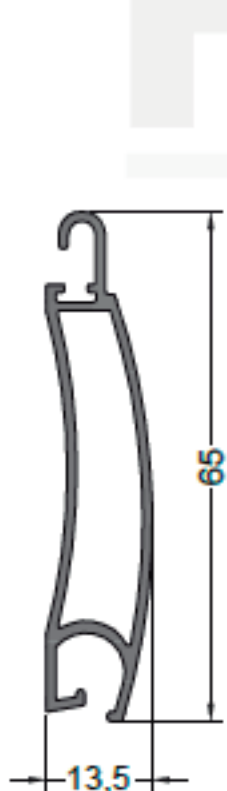
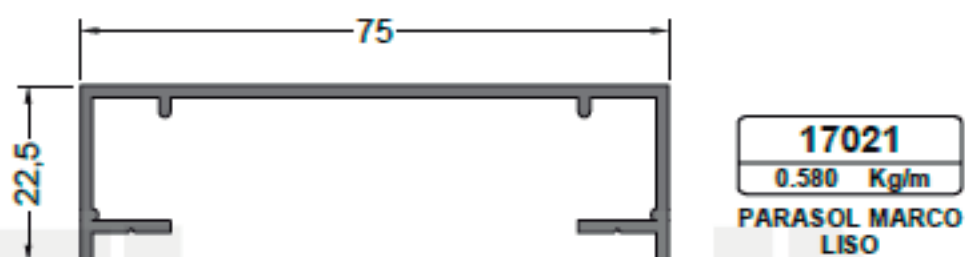
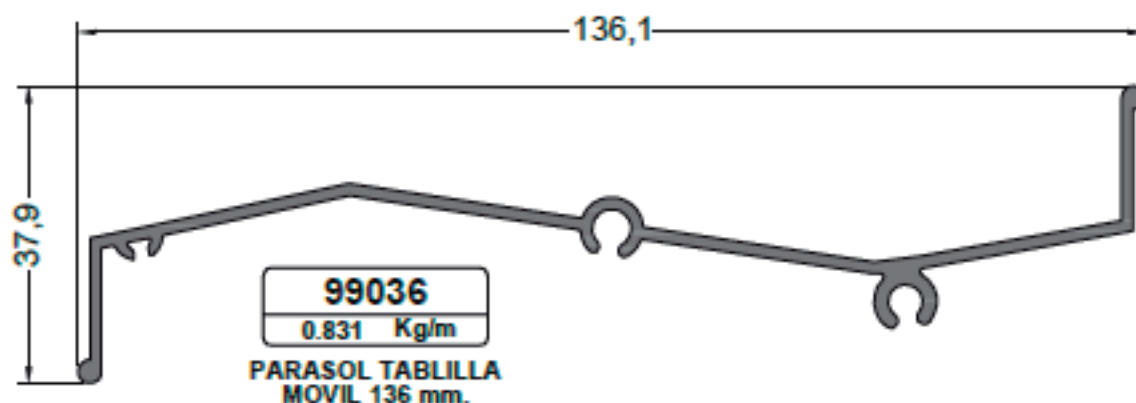

12646
0.499 Kg/m
CORTINA TABLILLA
CURVA

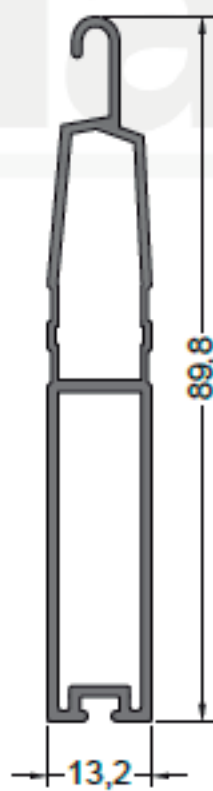

11777
0.697 Kg/m
CORTINA ZOCALO
PARA 12646



13437
0.554 Kg/m
CORTINA TABLILLA
REGULABLE

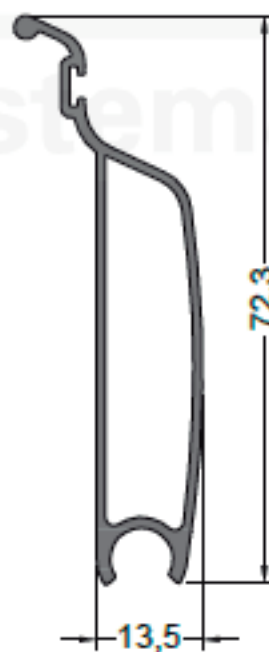

13461
0.527 Kg/m
CORTINA PRIMERA
TABLILLA



13462
1.002 Kg/m
CORTINA
ZOCALO

NOTA: LOS PESOS INDICADOS SON ESTIMADOS.

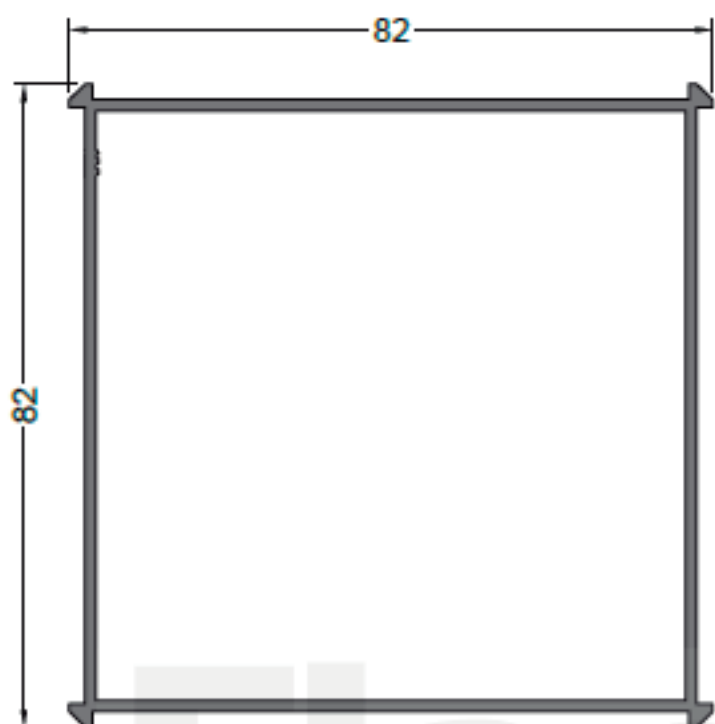

17043
1.225 Kg/m
ACOPLE 90°/180°

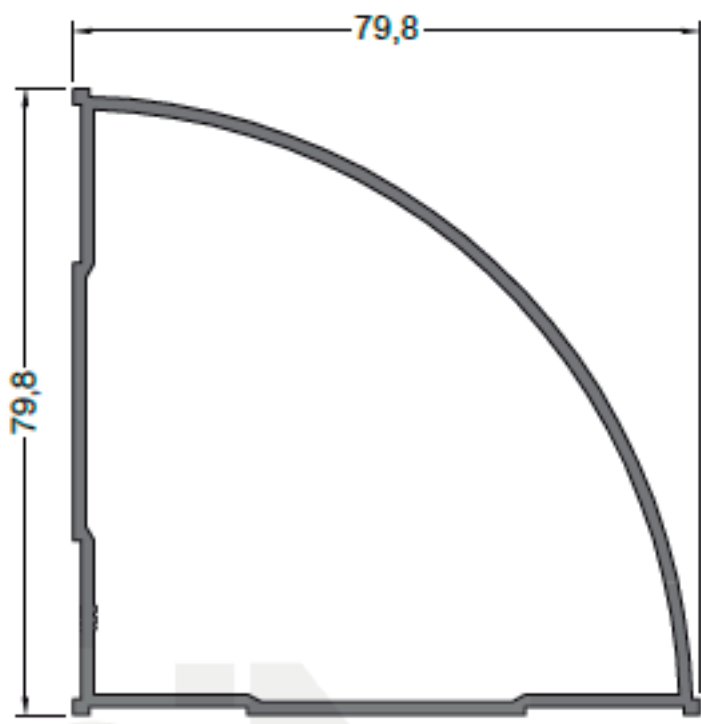

99186
1.207 Kg/m
ACOPLE 90°

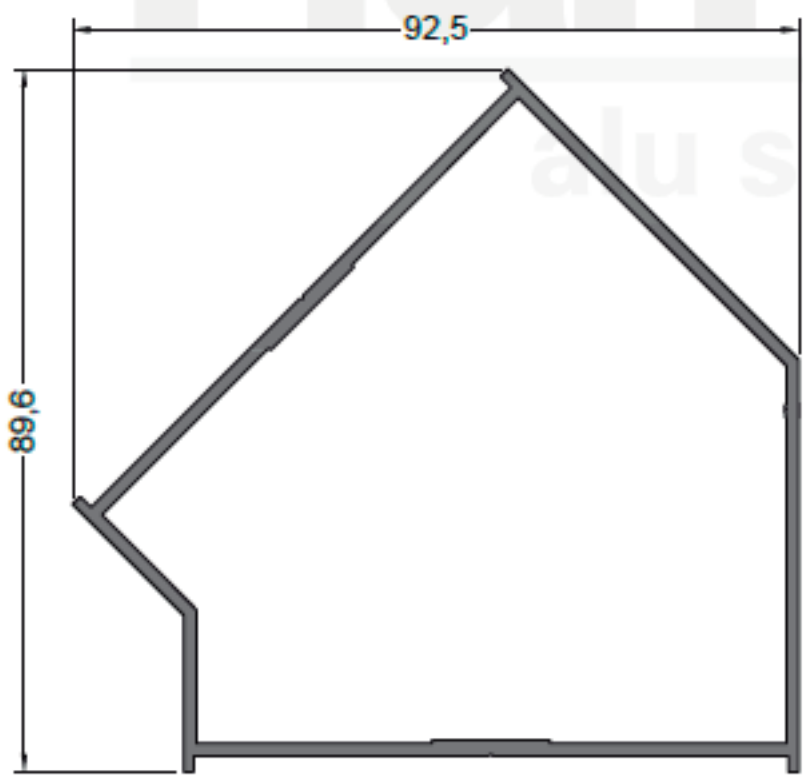

99718
1.304 Kg/m
ACOPLE 135°

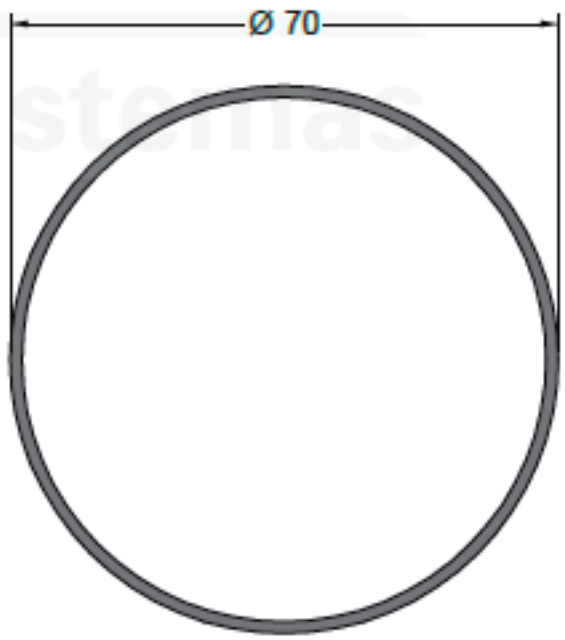

71705
0.870 Kg/m
ACOPLE ROTULA
CAÑO $\varnothing 70$ mm.

NOTA: LOS PESOS INDICADOS SON ESTIMADOS.

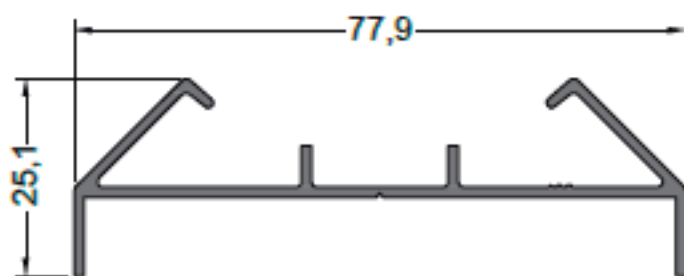

11737
0.528 Kg/m
ACOPLE ROTULA
90°/180°

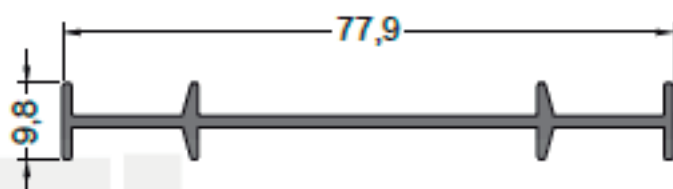

99049
0.416 Kg/m
ACOPLE 180°

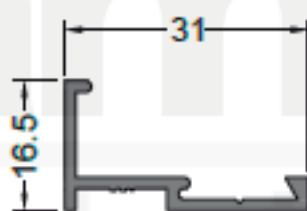

17038
0.211 Kg/m
PORTA CONTRAVIDRIO
CON ALA 16.5 mm.

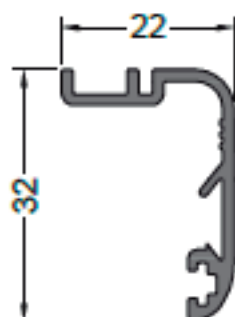

12540
0.281 Kg/m
TAPAJUNTA 32 mm.
AL MARCO

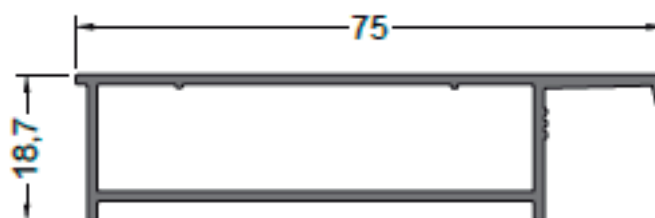

12662
0.563 Kg/m
PREMARCO
75 mm.

NOTA: LOS PESOS INDICADOS SON ESTIMADOS.

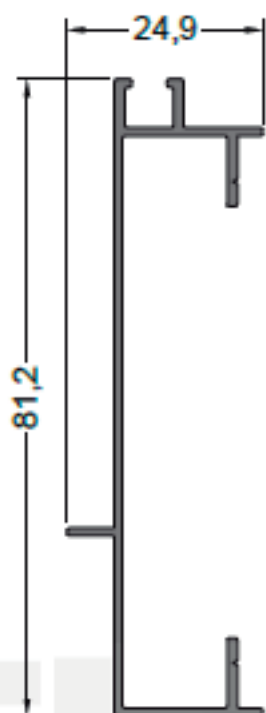

12795
0.426 Kg/m

AIREADOR MARCO 45°
CON MOSQUITERO

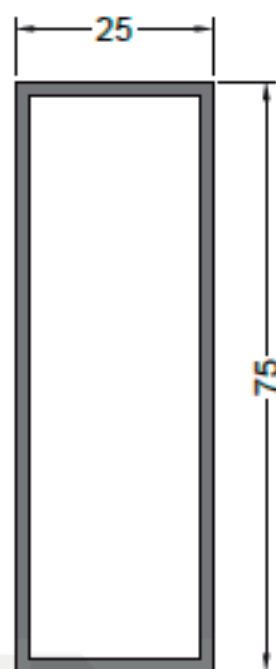

17033
0.836 Kg/m

FRENTE VIDRIERA
TUBO 75 x 25 mm.

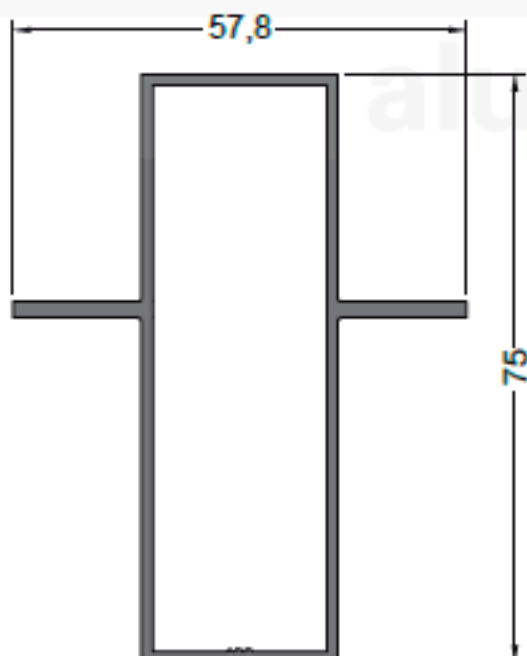

17034
0.915 Kg/m

FRENTE VIDRIERA TUBO
CON 2 ALETAS 75 x 25 mm.

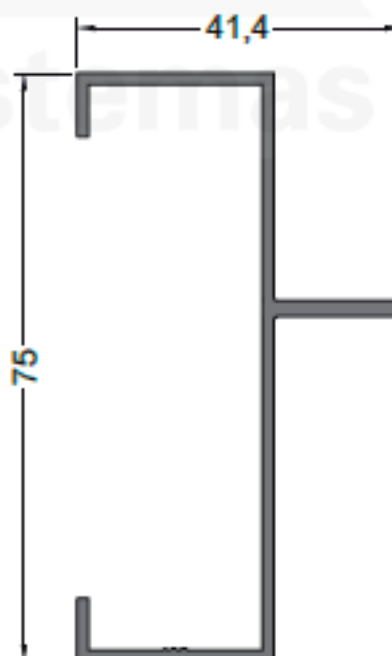

17035
0.603 Kg/m

FRENTE VIDRIERA MARCO
ABIERTO 1 ALETA 75 X 25 mm.

NOTA: LOS PESOS INDICADOS SON ESTIMADOS.

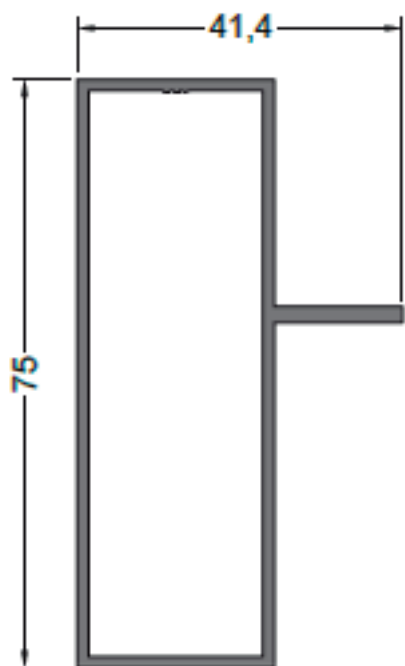

17036
0.826 Kg/m

FRENTE VIDRIERA TUBO
CON 1 ALETA 75 x 25 mm.

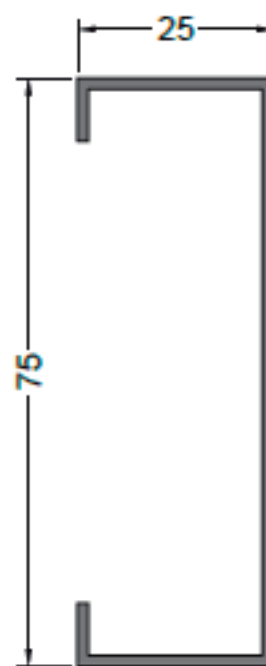

17037
0.511 Kg/m

FRENTE VIDRIERA MARCO
LISO 75 x 25 mm.

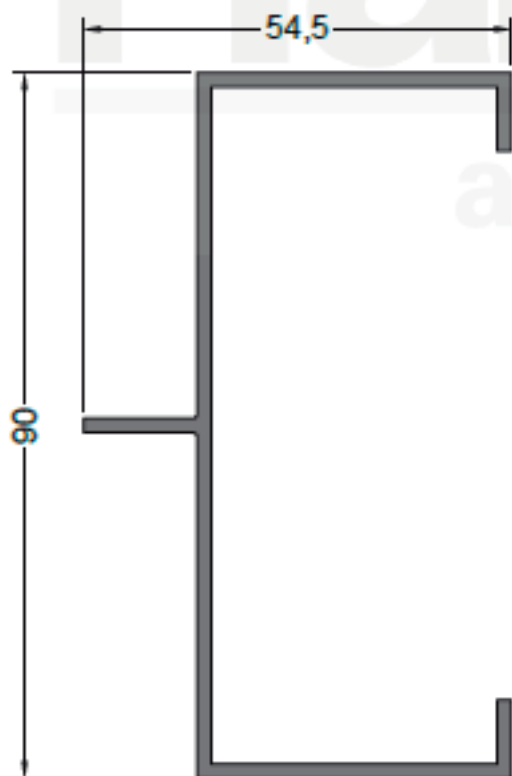

99484
0.963 Kg/m

FRENTE VIDRIERA MARCO
CON 1 ALETA 90 x 40 mm.

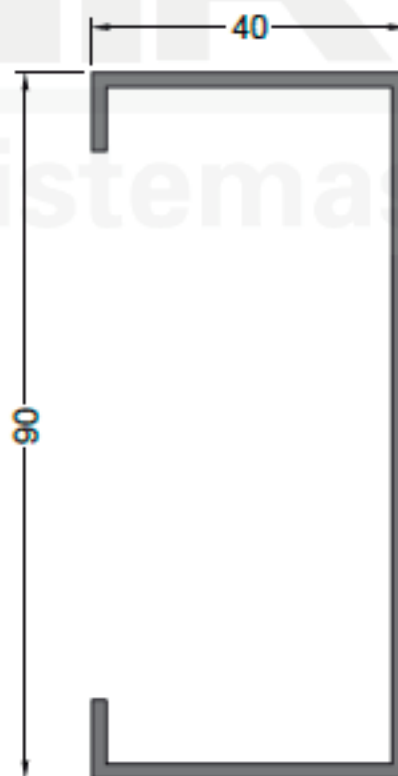

99483
0.888 Kg/m

FRENTE VIDRIERA MARCO
LISO 90 x 40 mm.

NOTA: LOS PESOS INDICADOS SON ESTIMADOS.

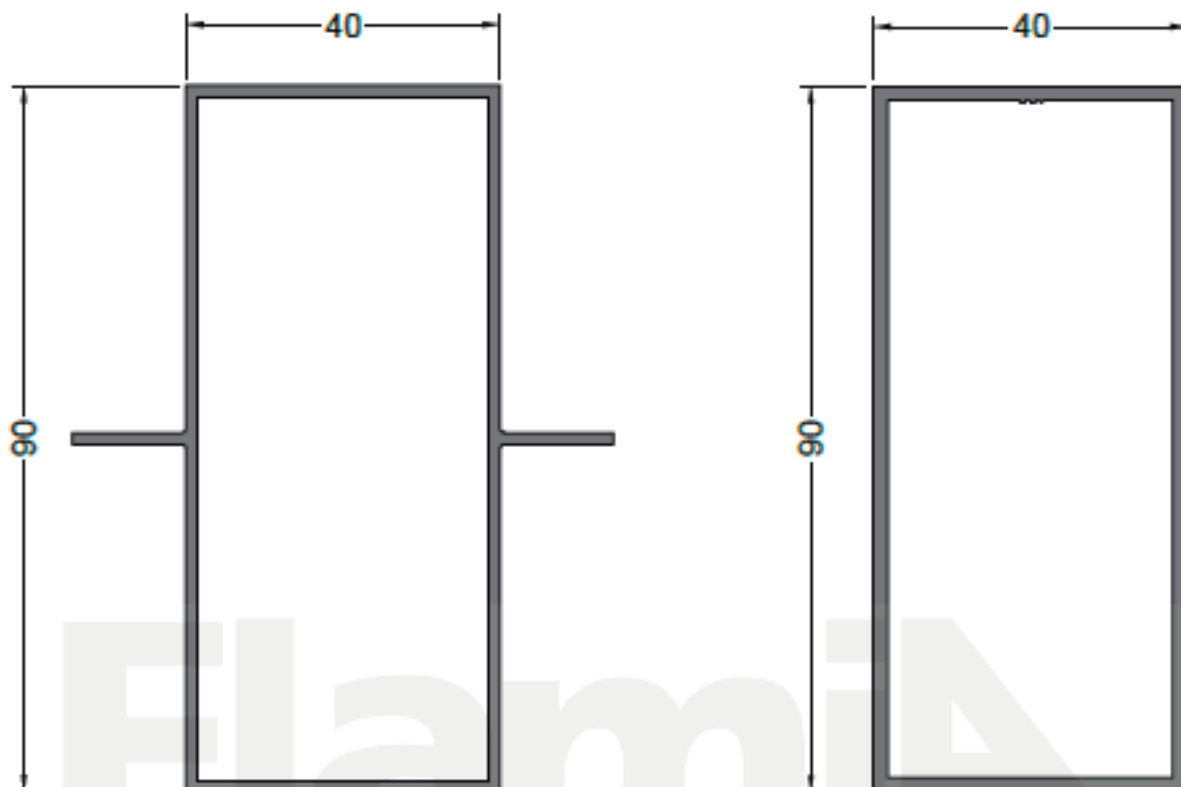

99493
1.147 Kg/m
FRETE VIDRIERA TUBO
CON 2 ALETAS 90 x 40 mm.

11193
1.233 Kg/m
FRETE VIDRIERA
TUBO 90x40 mm.

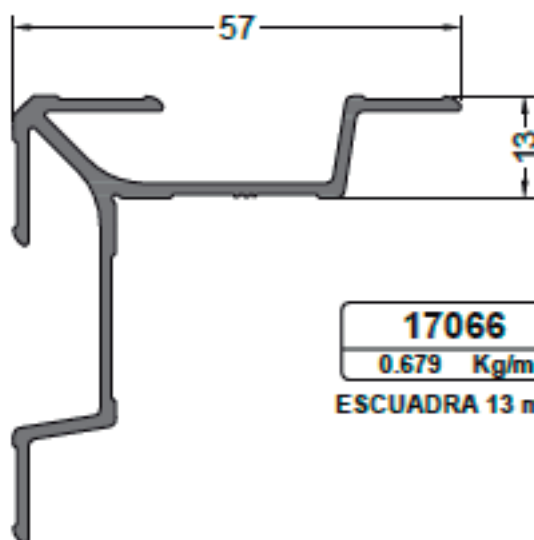

17066
0.679 Kg/m
ESCUADRA 13 mm.

NOTA: LOS PESOS INDICADOS SON ESTIMADOS.

SISTEMAS DE CARPINTERIA

Standard

VENTANA CORREDIZA



Corte horizontal ventana corrediza 2 y 4 hojas Hoja 12003.

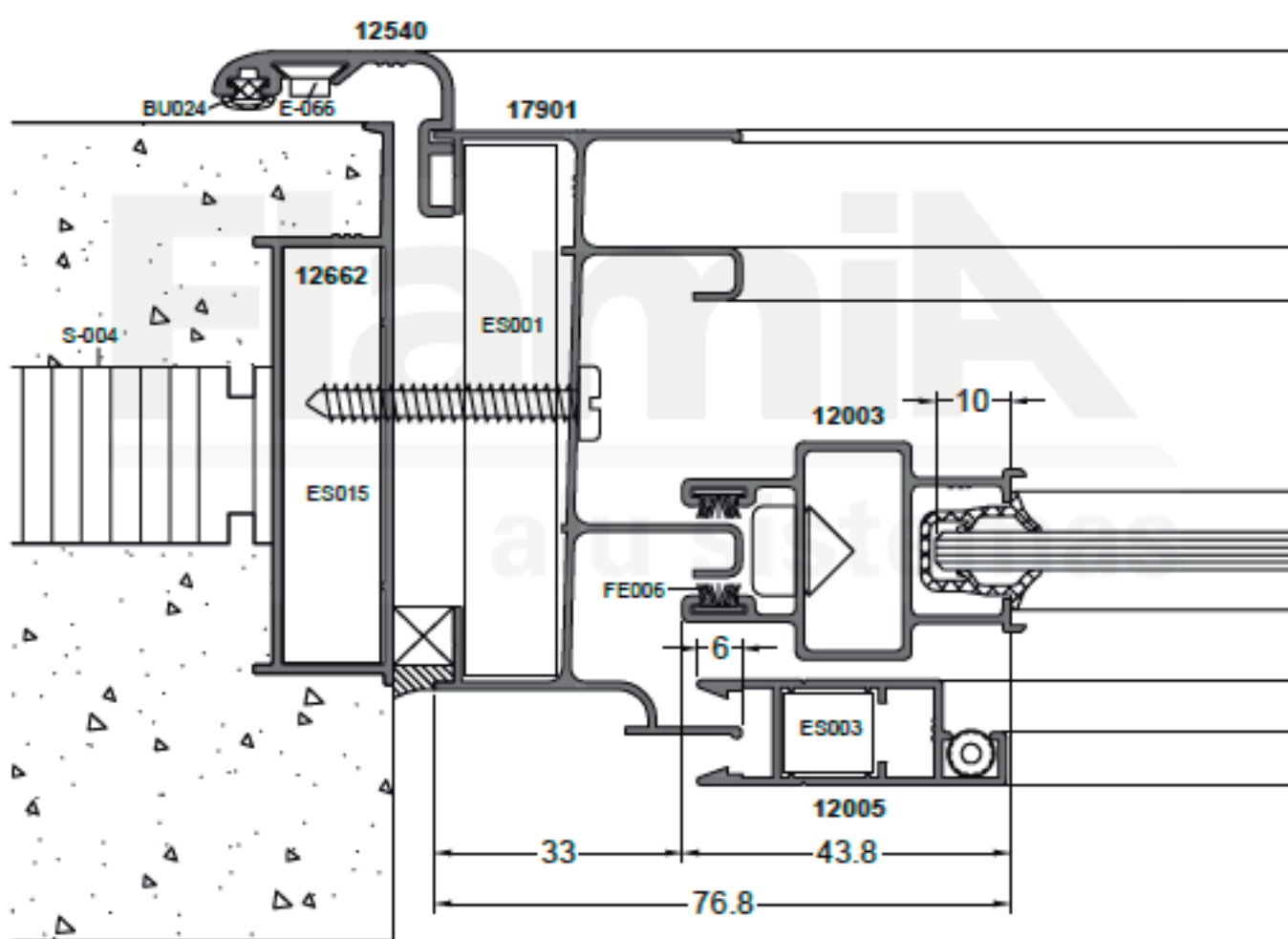
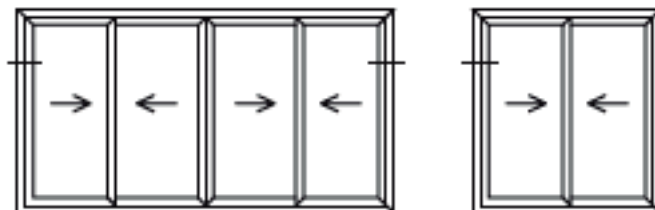

Corte horizontal ventana corrediza 2 y 4 hojas
Hoja 12003.

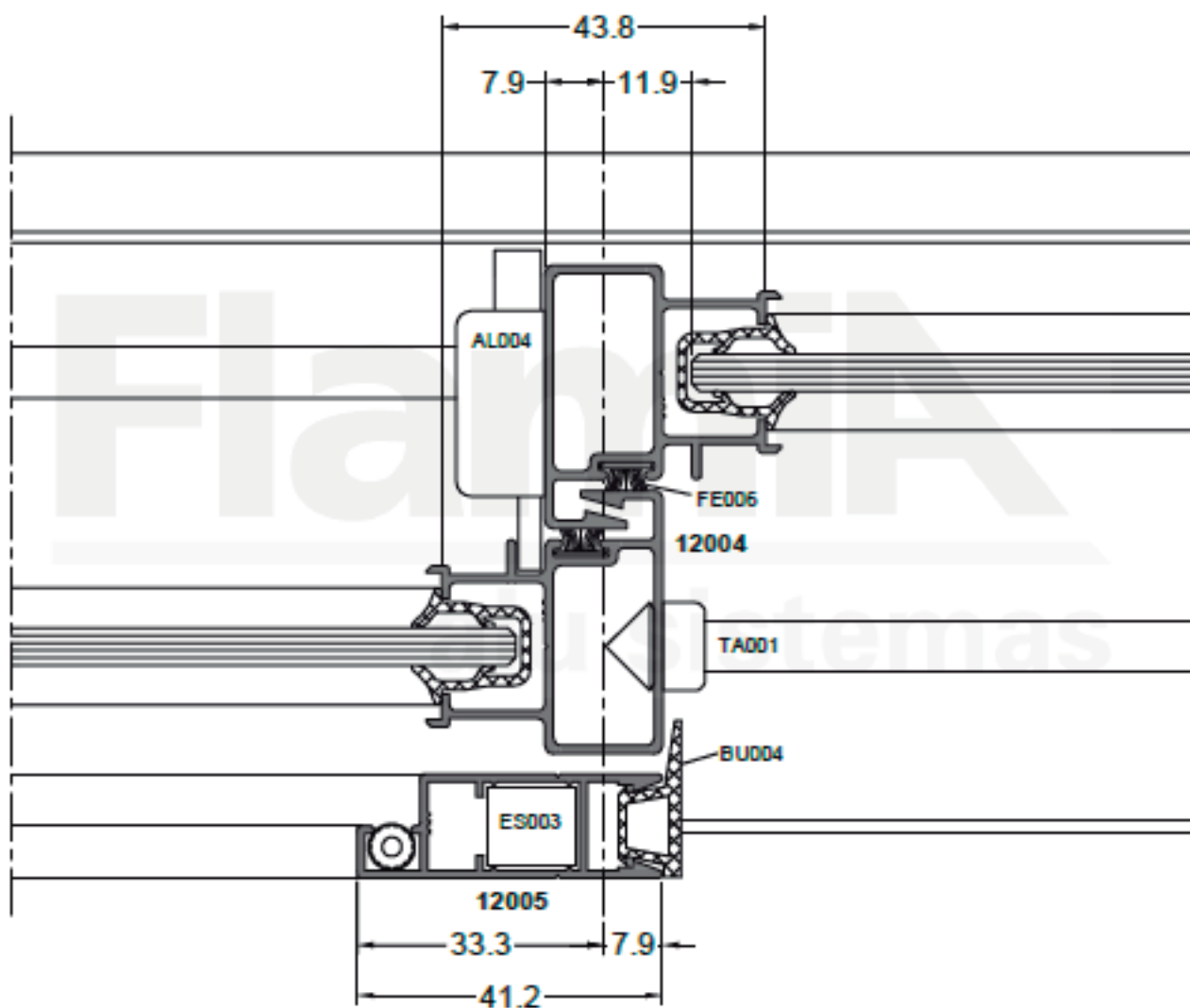
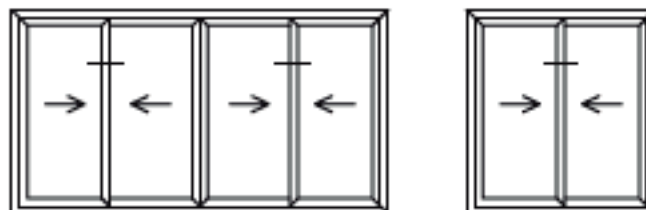

Corte horizontal ventana corrediza 2 y 4 hojas
Hoja 12003.

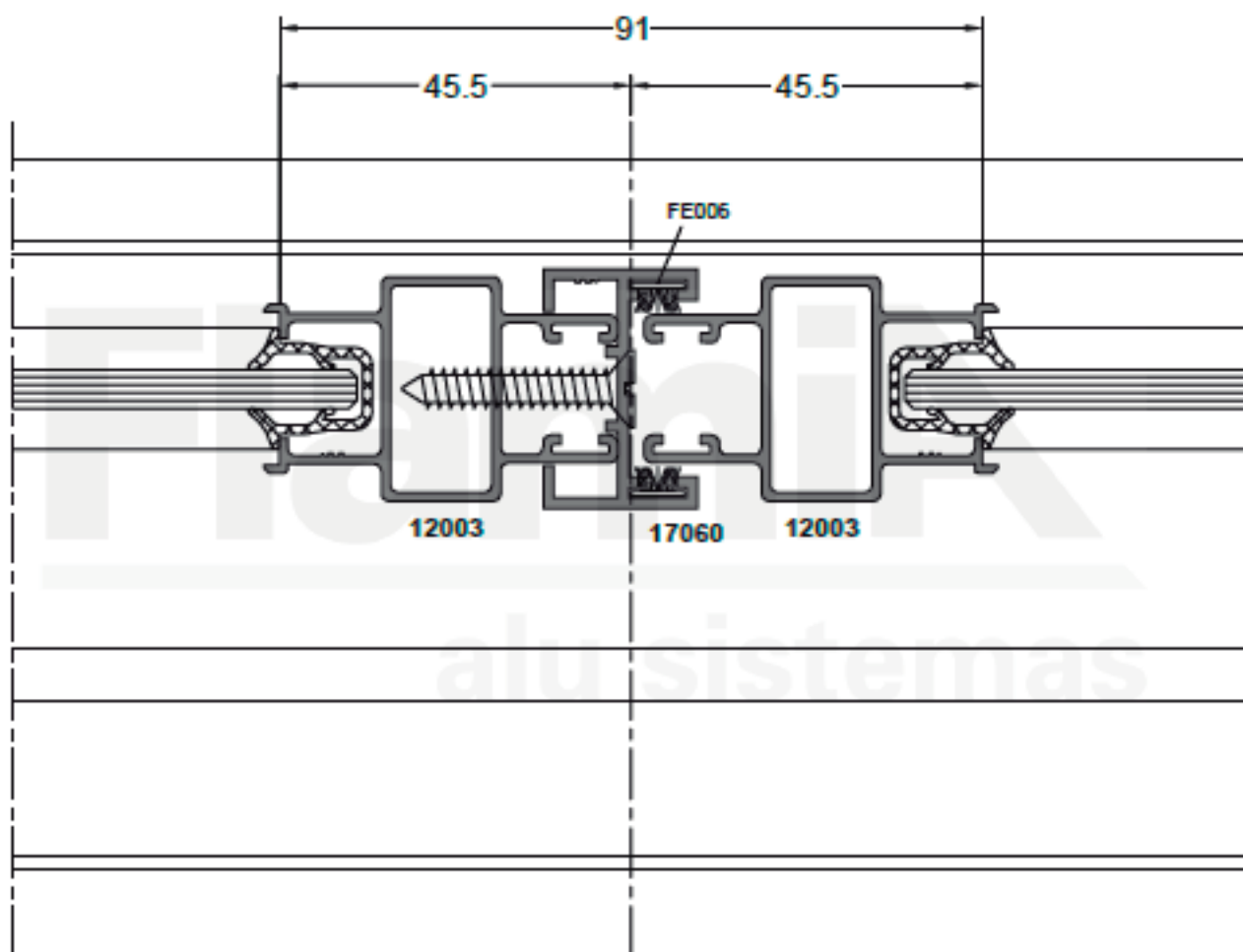
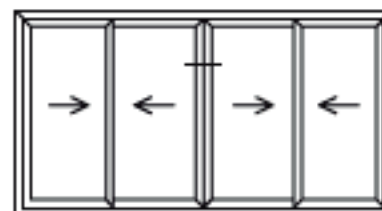

Corte horizontal ventana corrediza 2 y 4 hojas
Hoja 12003.

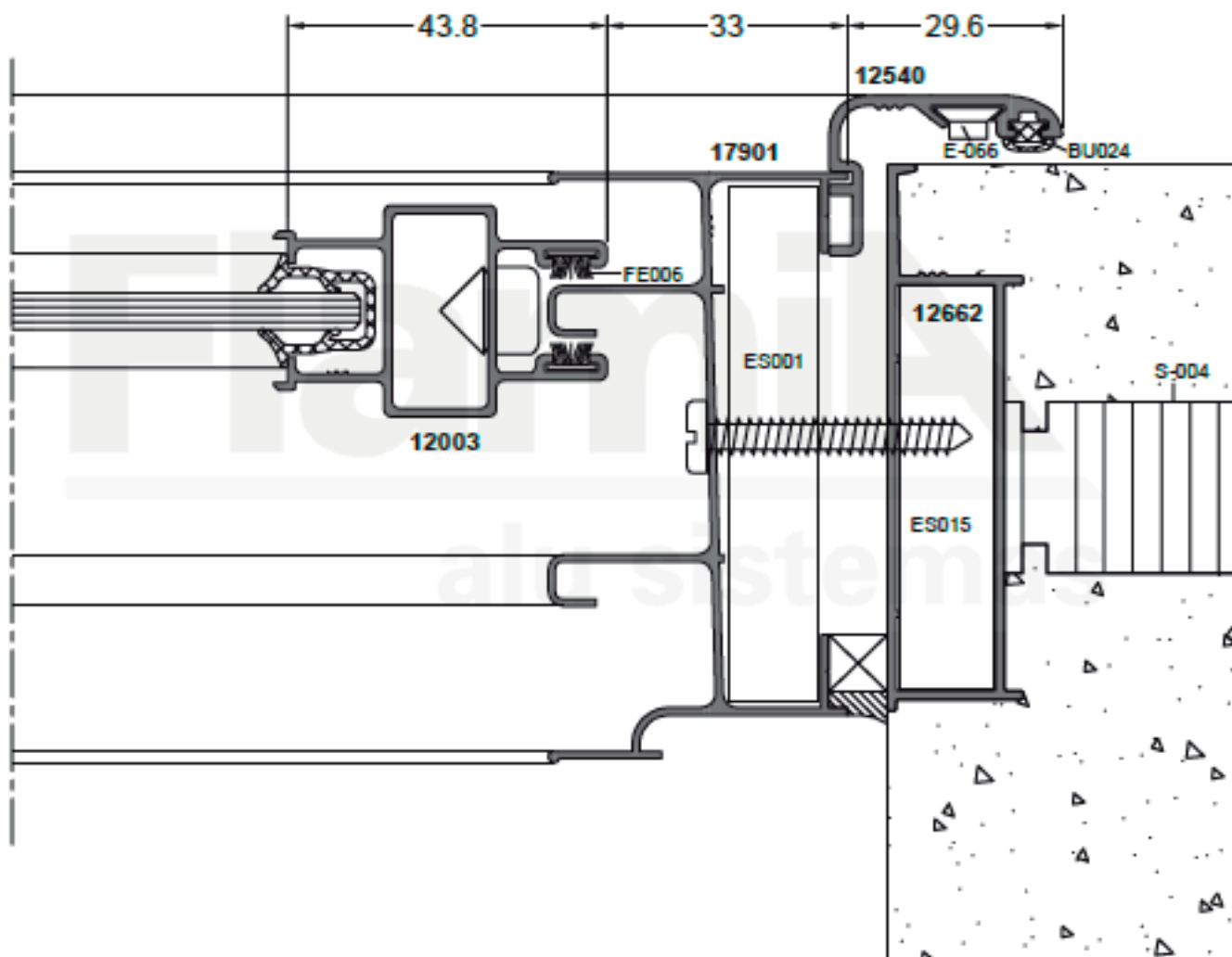
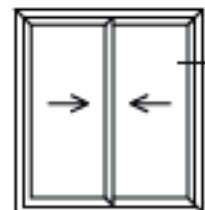

Corte vertical ventana corrediza 2 y 4 hojas
Hoja 12003.

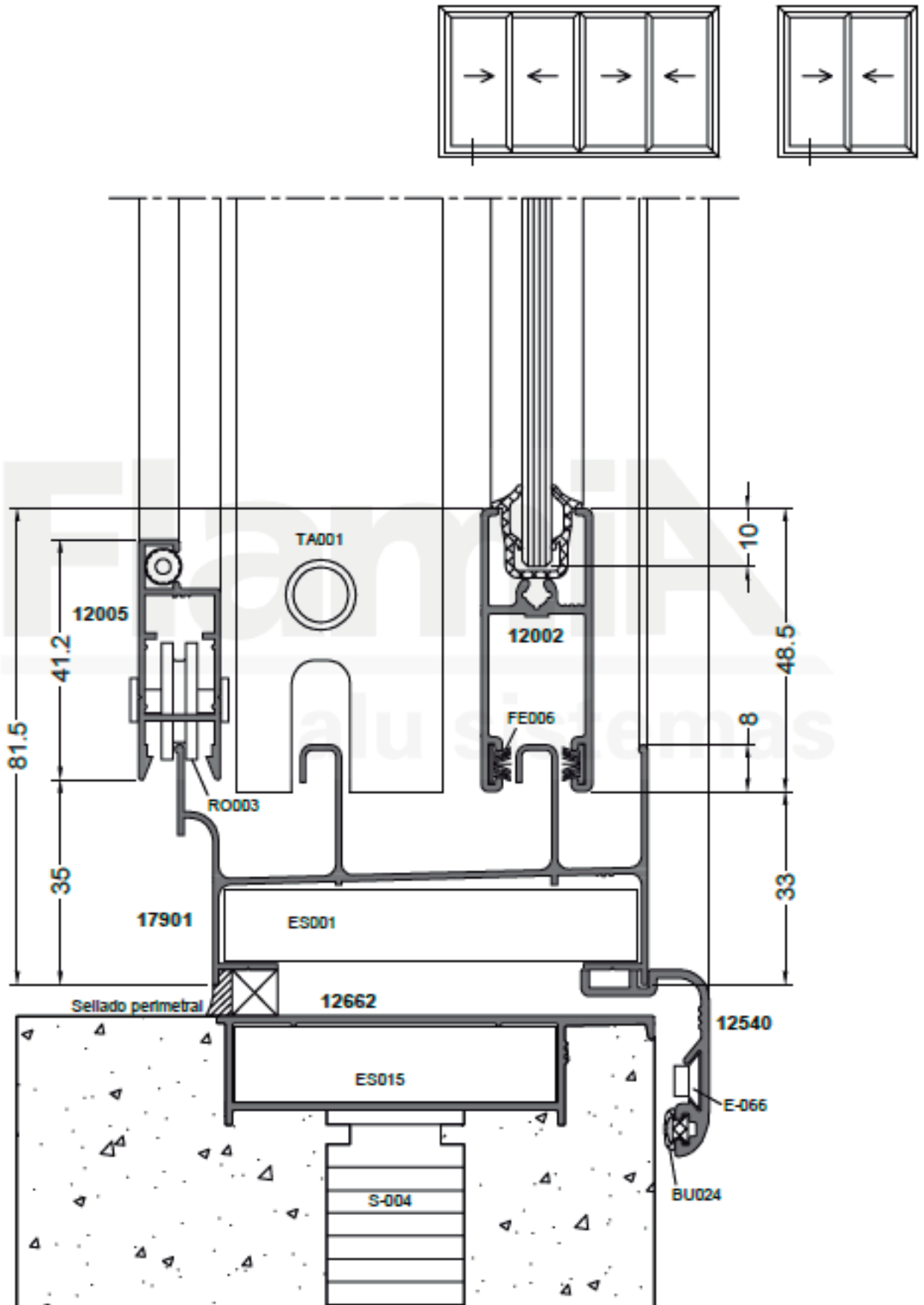

Corte vertical ventana corrediza 2 y 4 hojas
Hoja 12003.

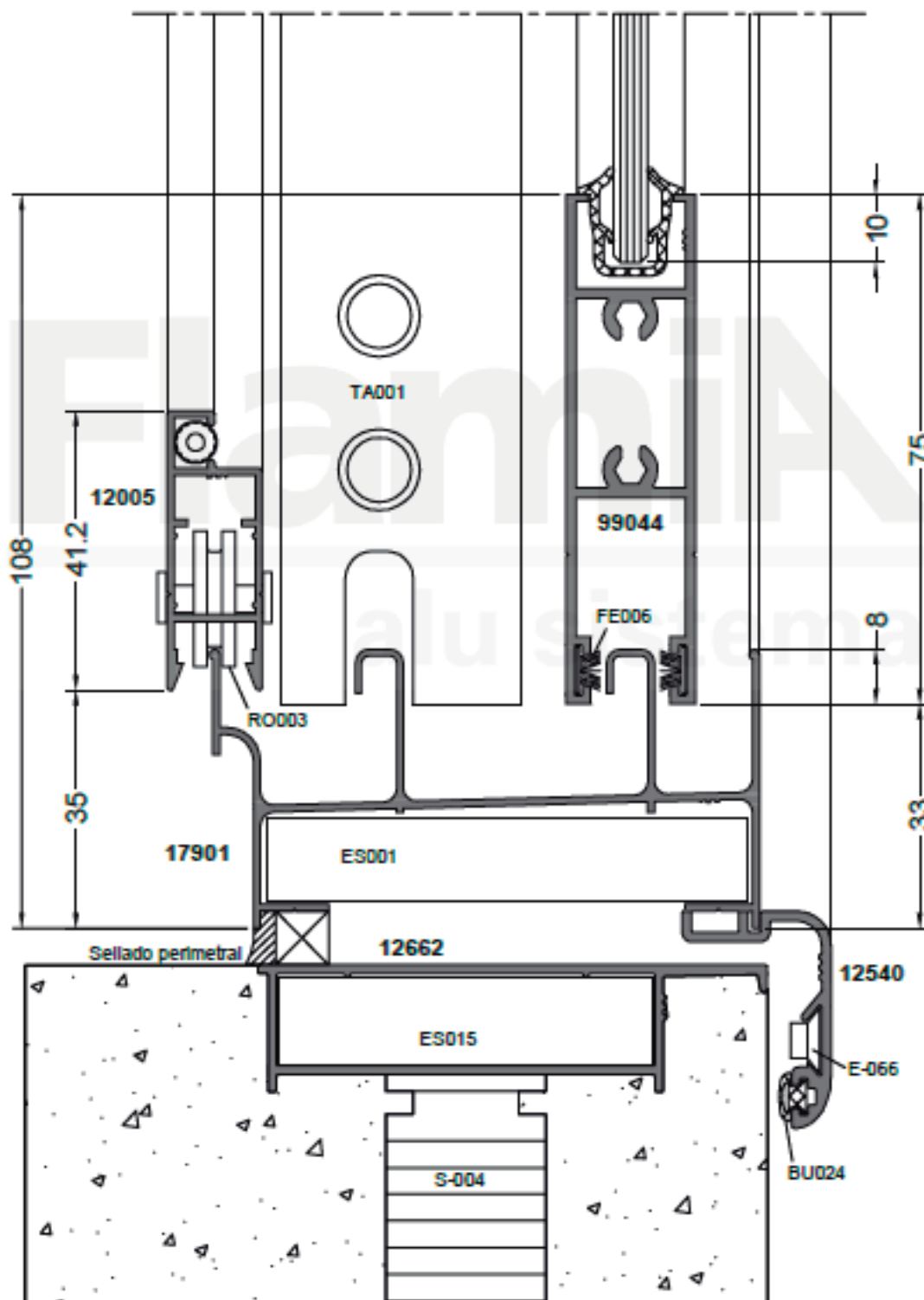
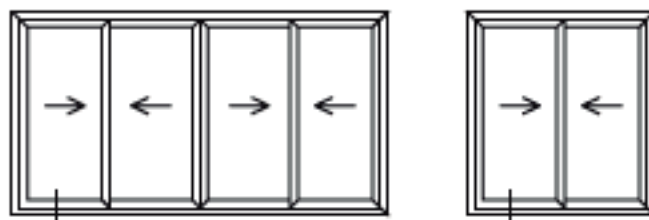

Corte vertical ventana corrediza 2 y 4 hojas Hoja 12003.

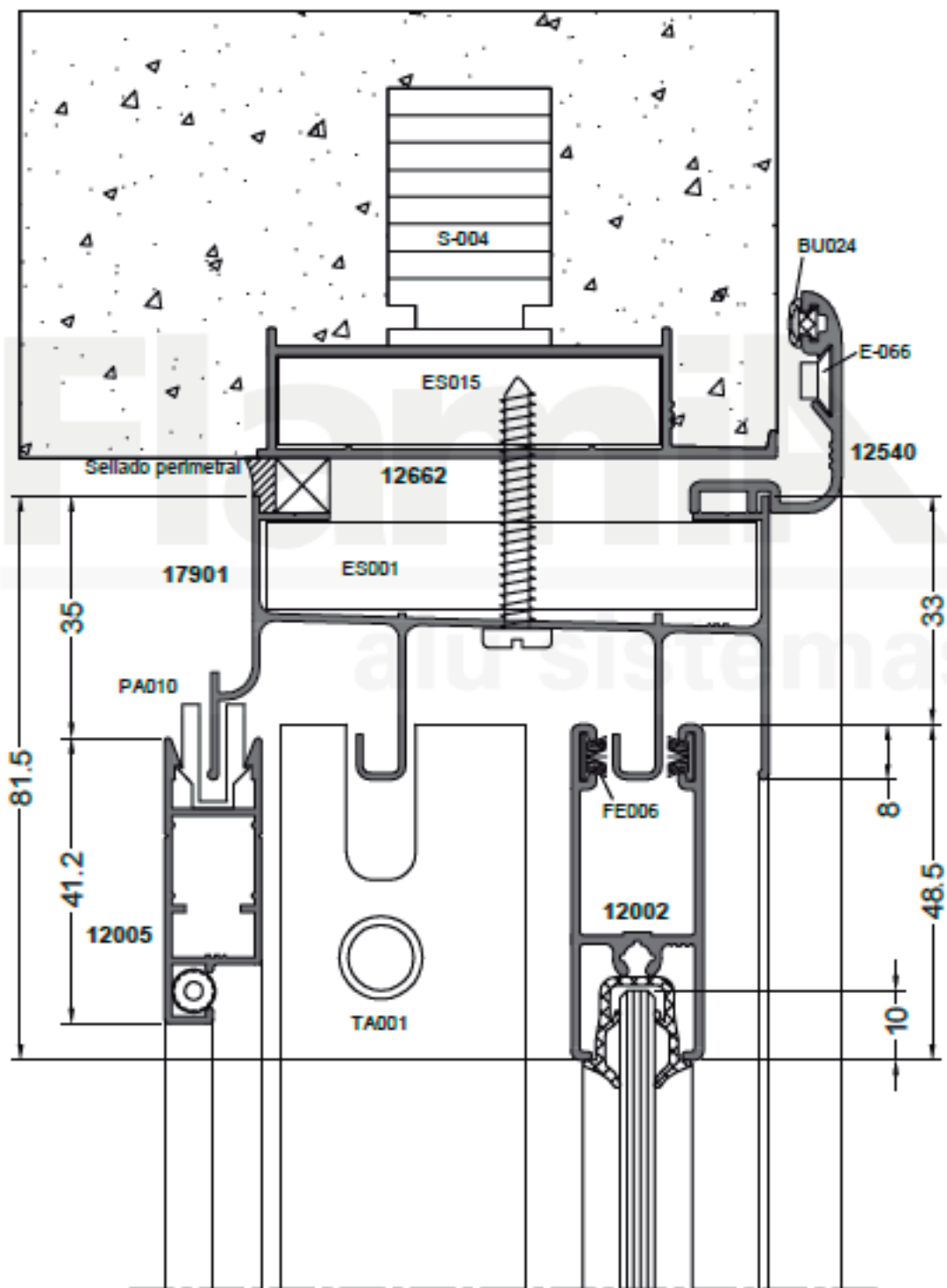
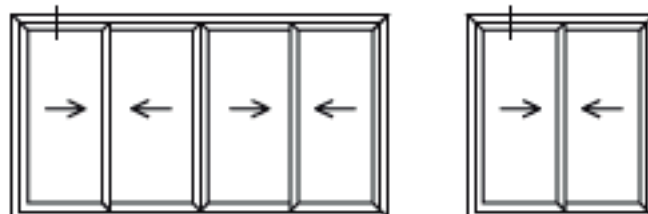

Corte horizontal ventana corrediza 2 y 4 hojas
 Hoja 99053.

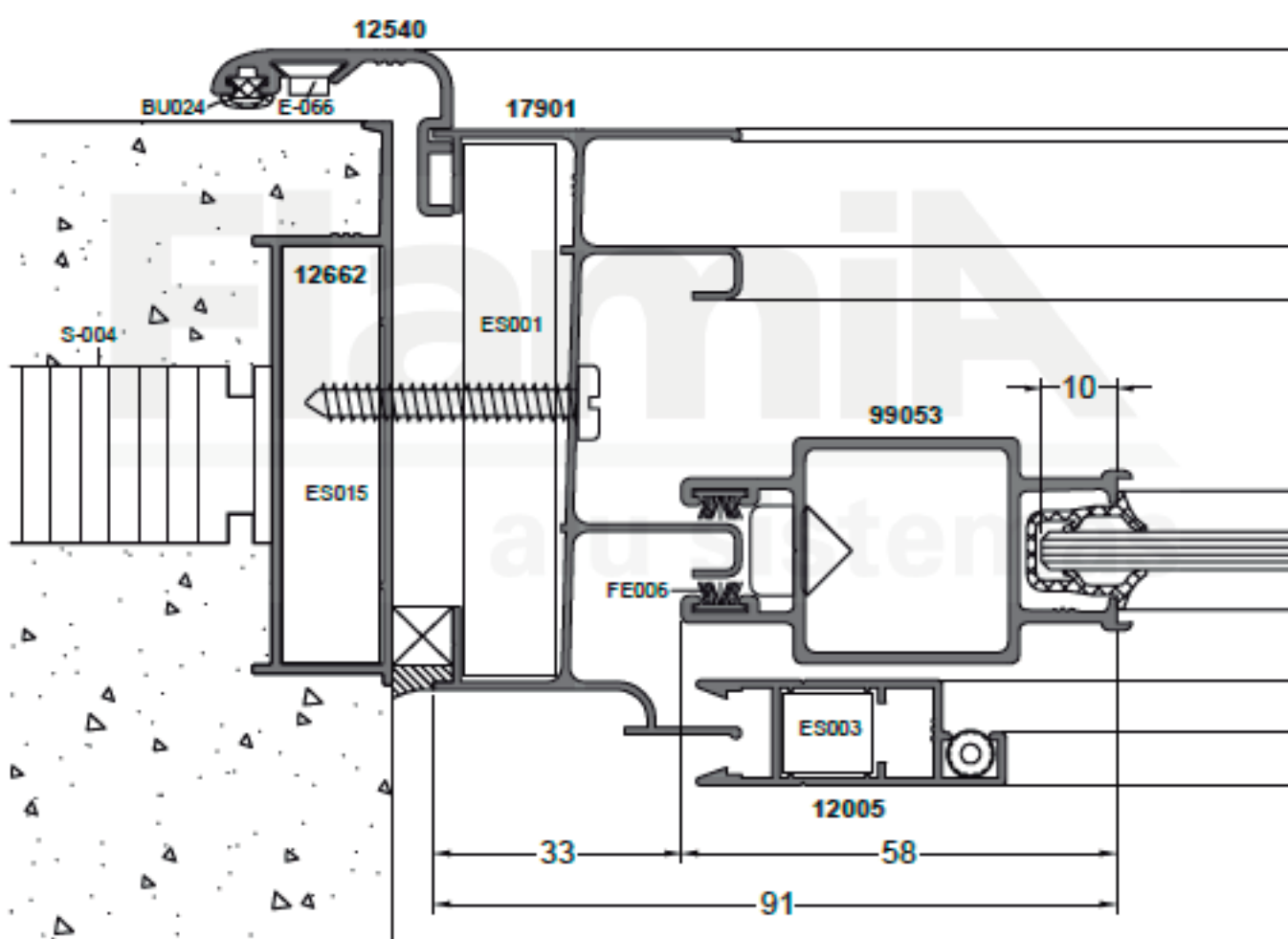
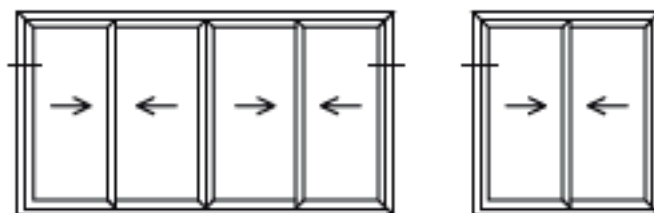

Corte horizontal ventana corrediza 2 y 4 hojas
Hoja 99053.

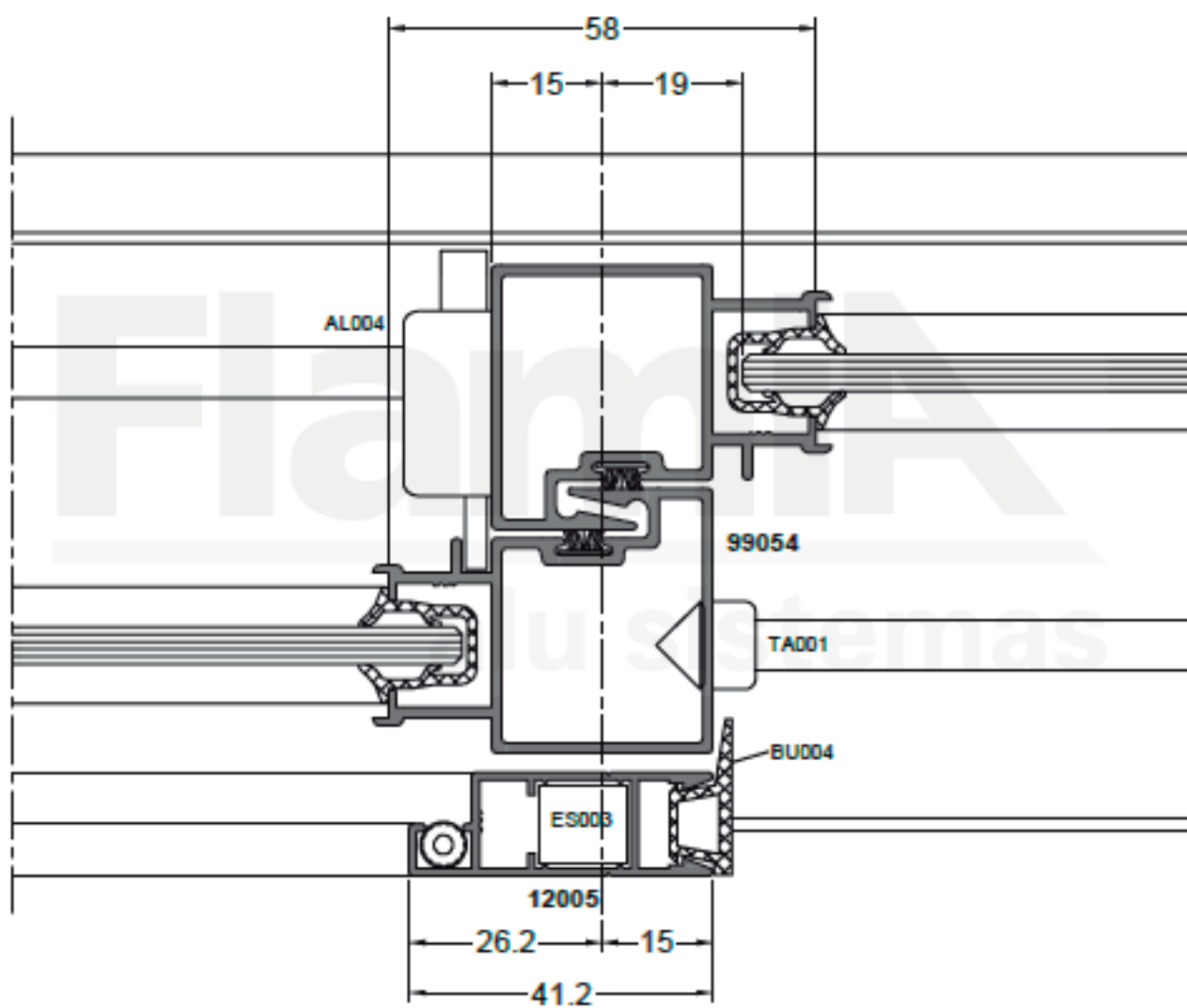
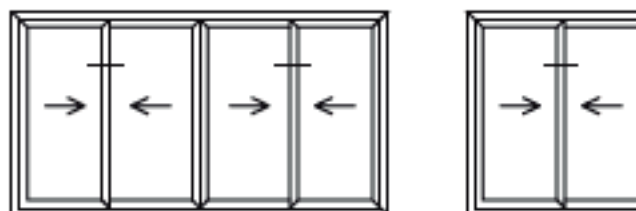

Corte horizontal ventana corrediza 2 y 4 hojas
Hoja 99053.

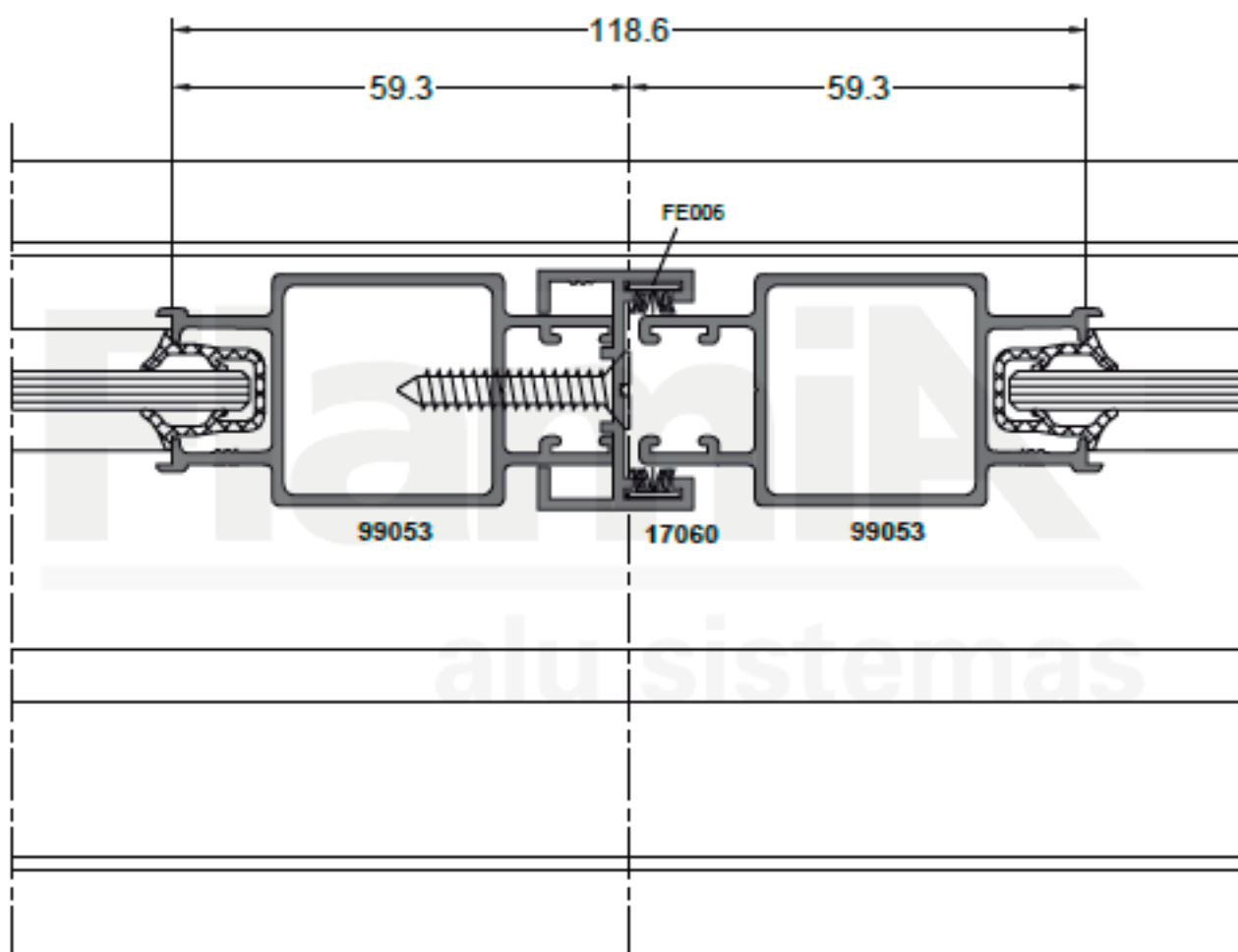
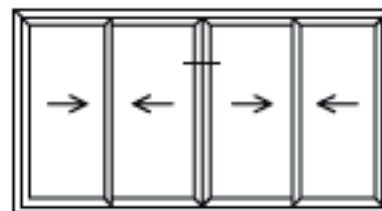

Corte horizontal ventana corrediza 2 y 4 hojas
Hoja 99053.

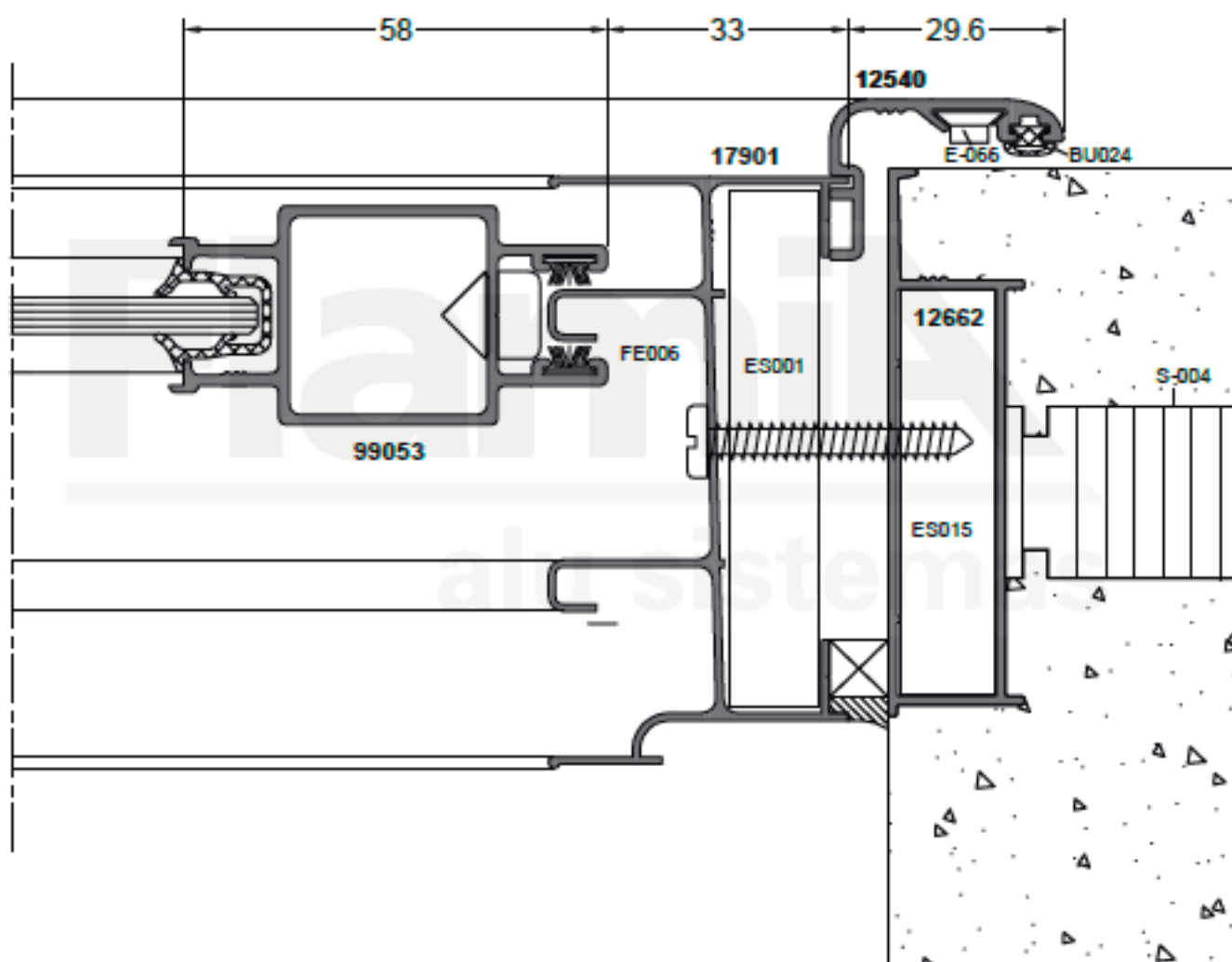
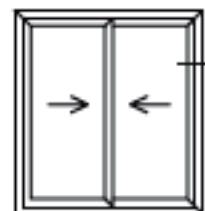

Corte vertical ventana corrediza 2 y 4 hojas
Hoja 99053.

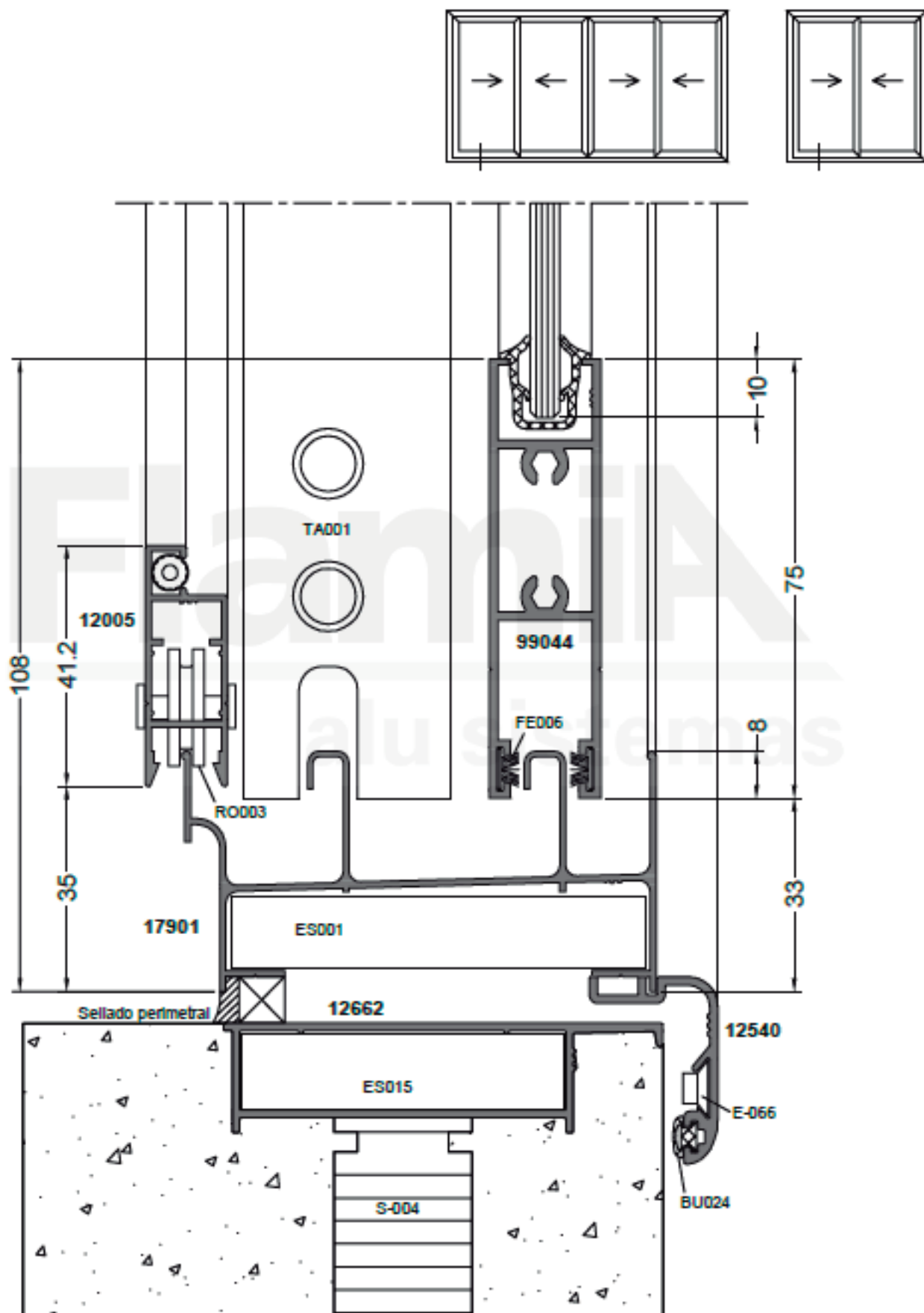

Corte vertical ventana corrediza 2 y 4 hojas
Hoja 99053.

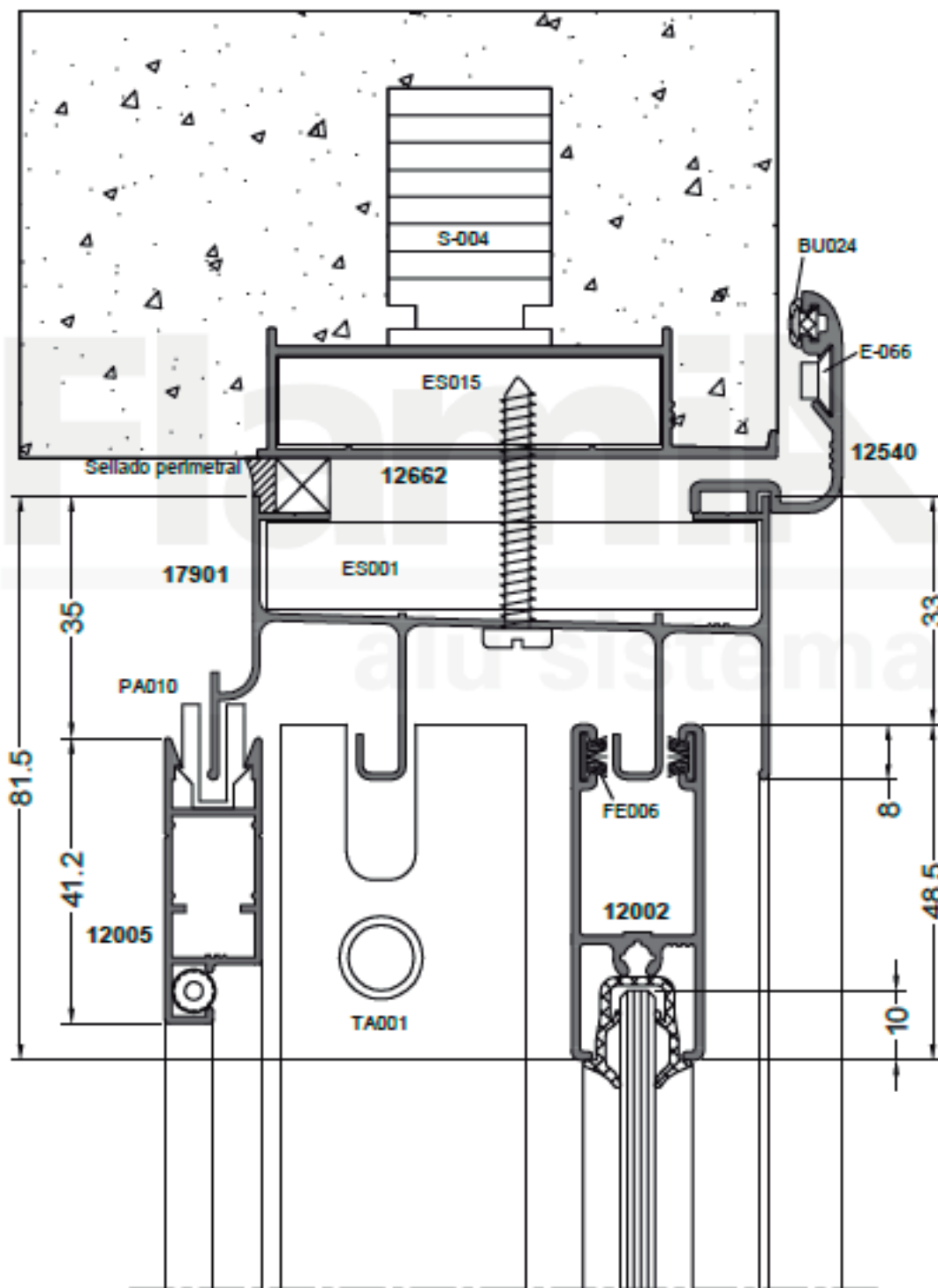
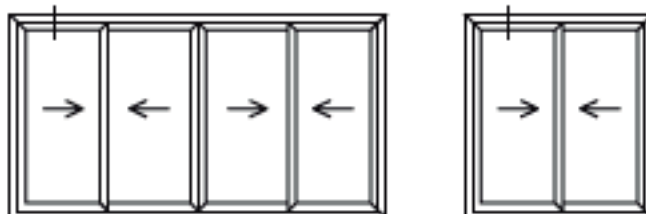

Corte horizontal ventana corrediza 3 hojas
 Hoja 12003.

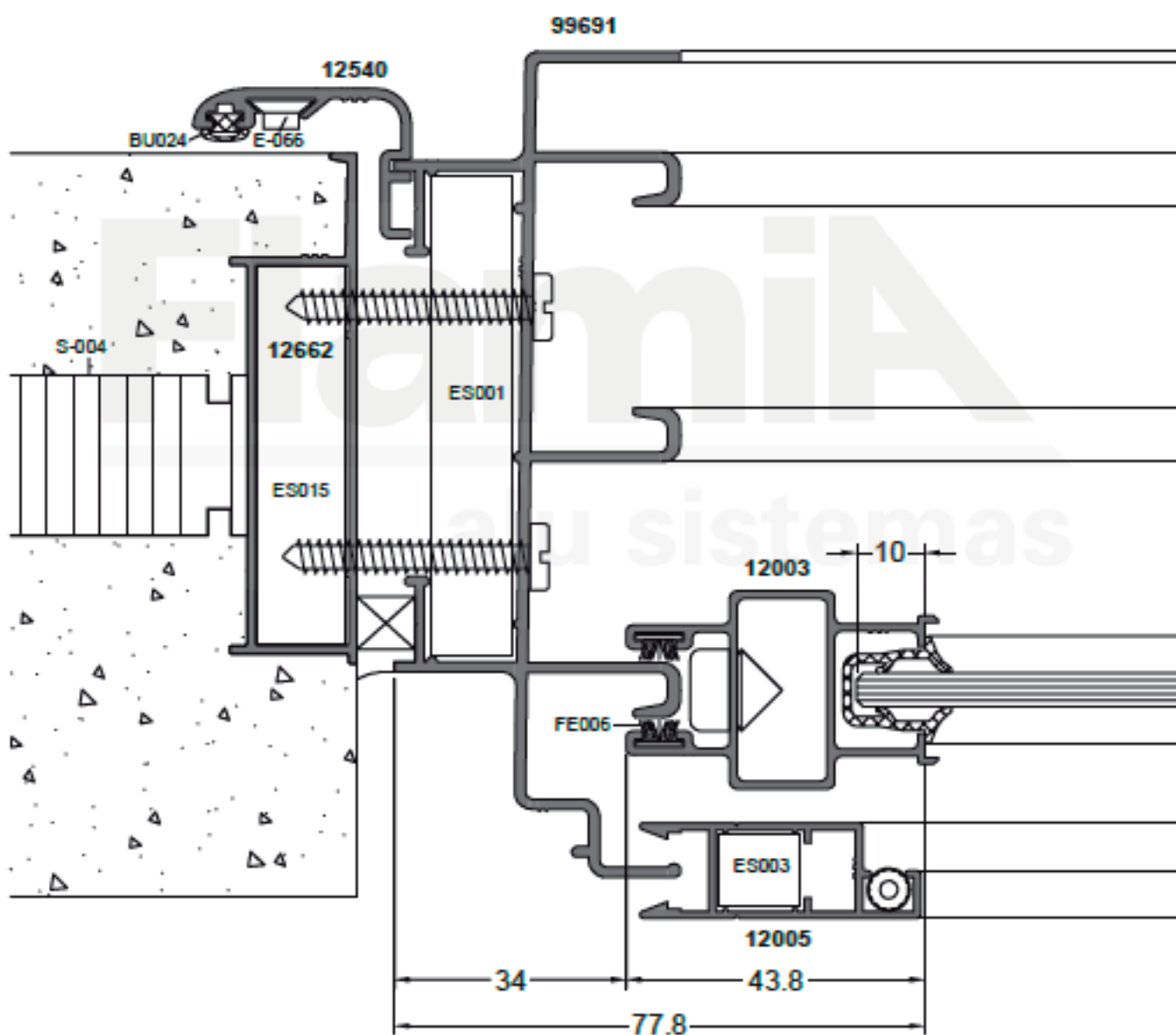
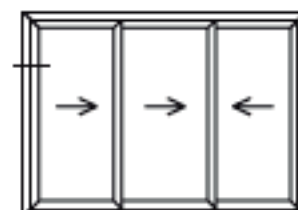

Corte horizontal ventana corrediza 3 hojas
Hoja 12003.

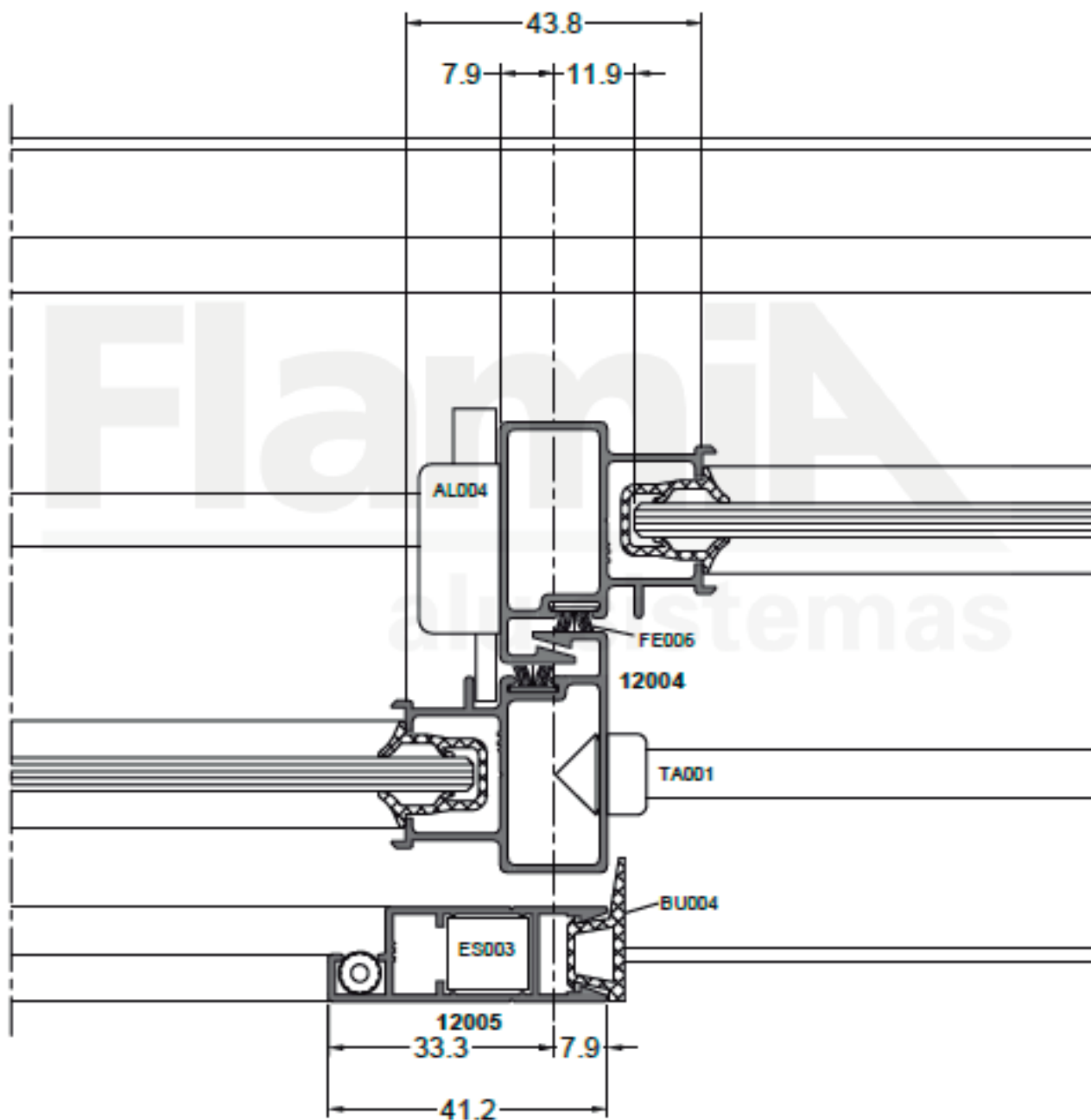
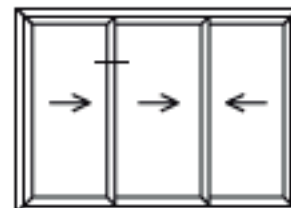

Corte horizontal ventana corrediza 3 hojas
Hoja 12003.

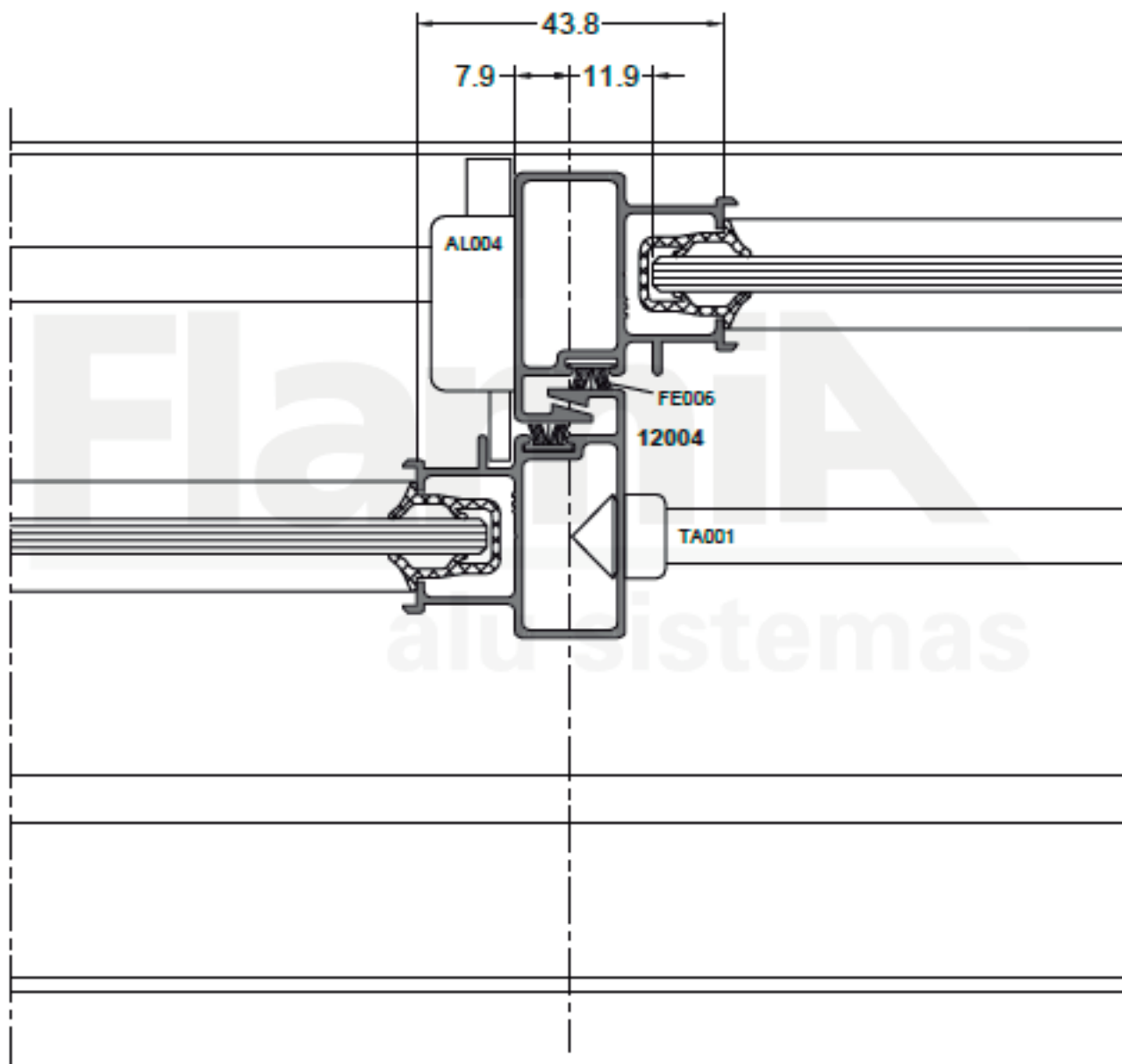
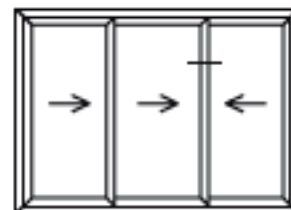

Corte horizontal ventana corrediza 3 hojas
Hoja 12003.

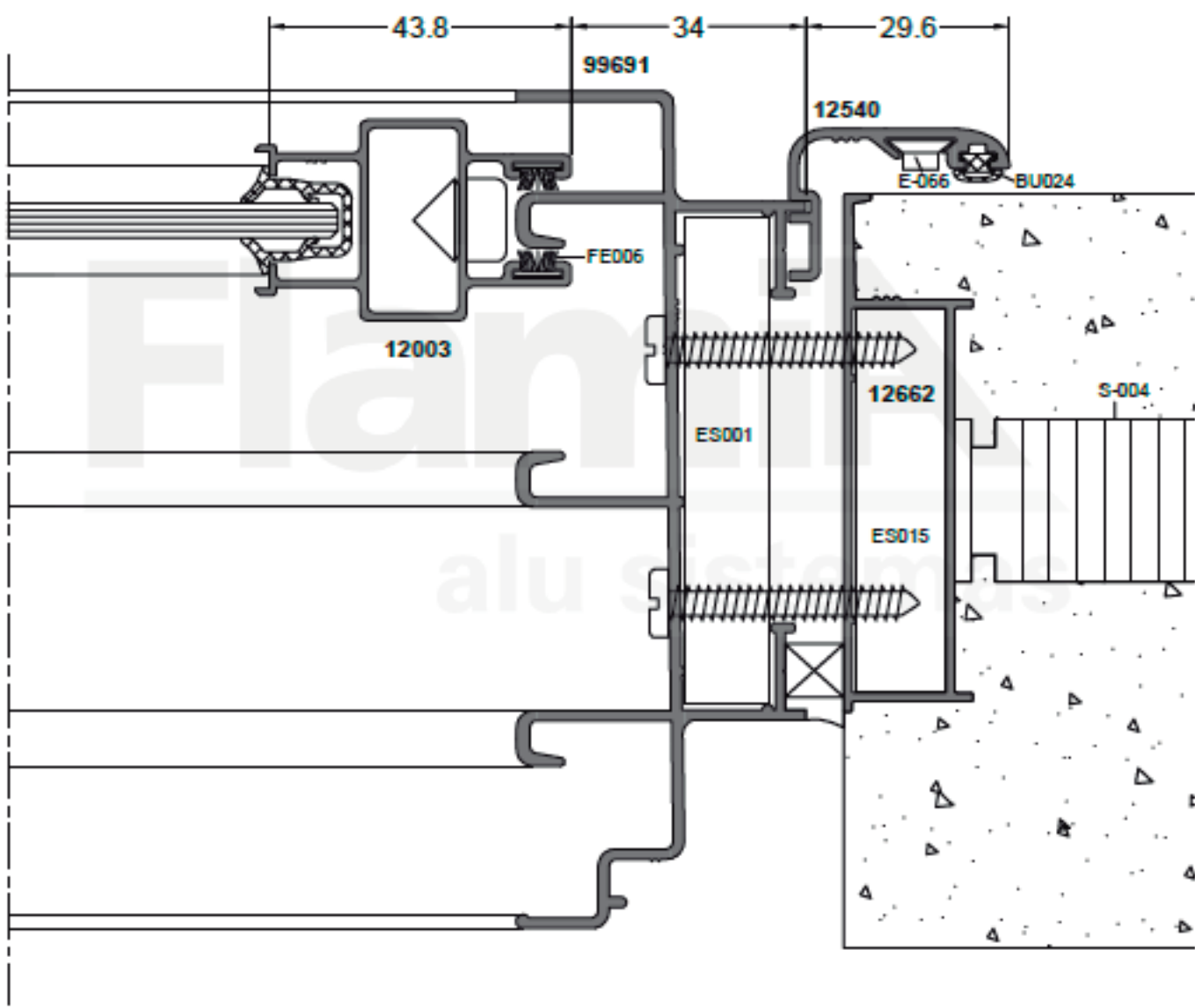
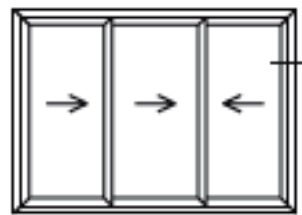

Corte vertical ventana corrediza 3 hojas
Hoja 12003.

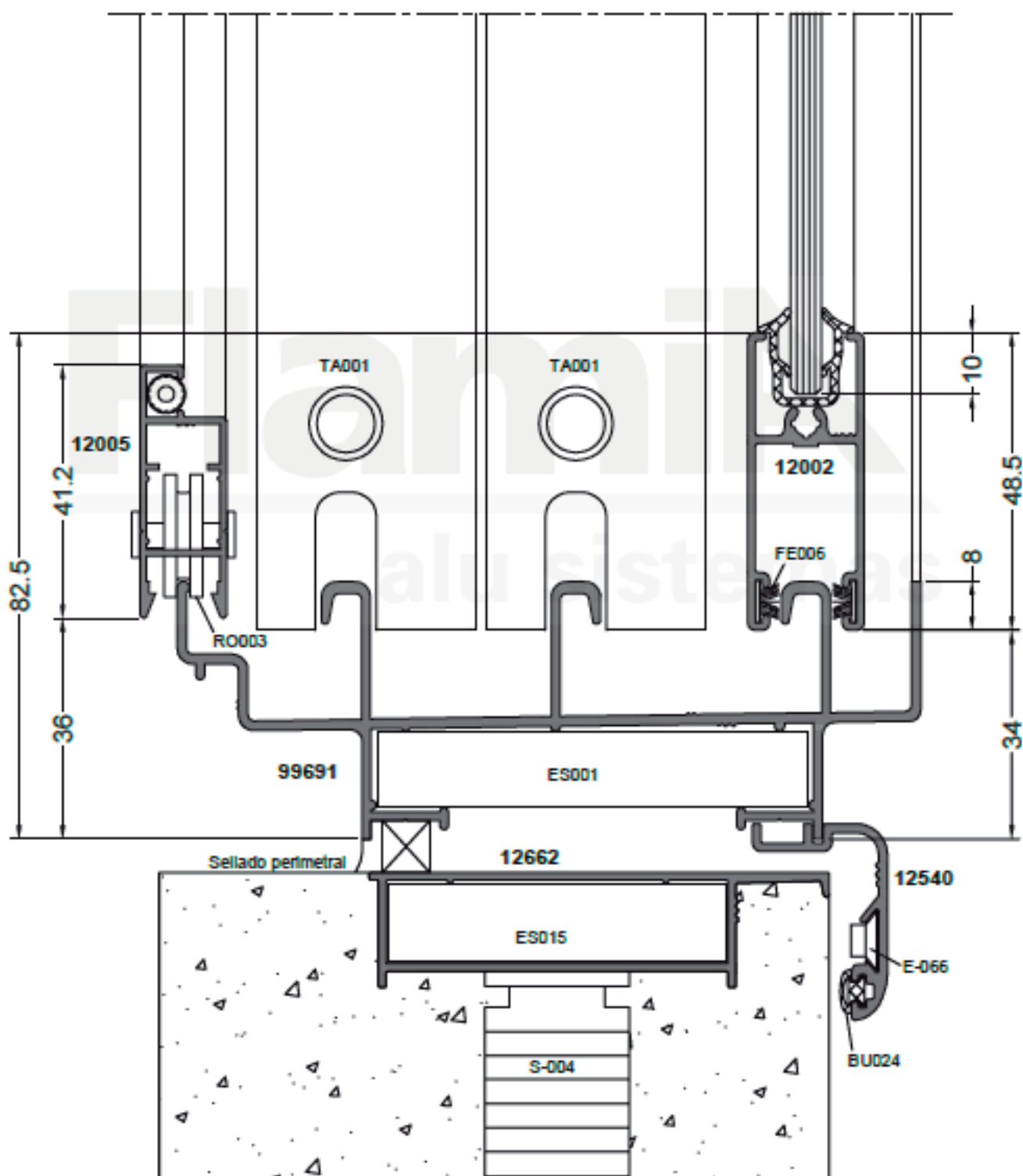
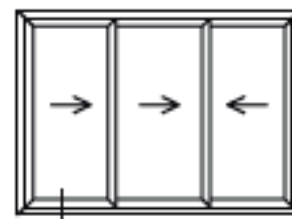

Corte vertical ventana corrediza 3 hojas
Hoja 12003.

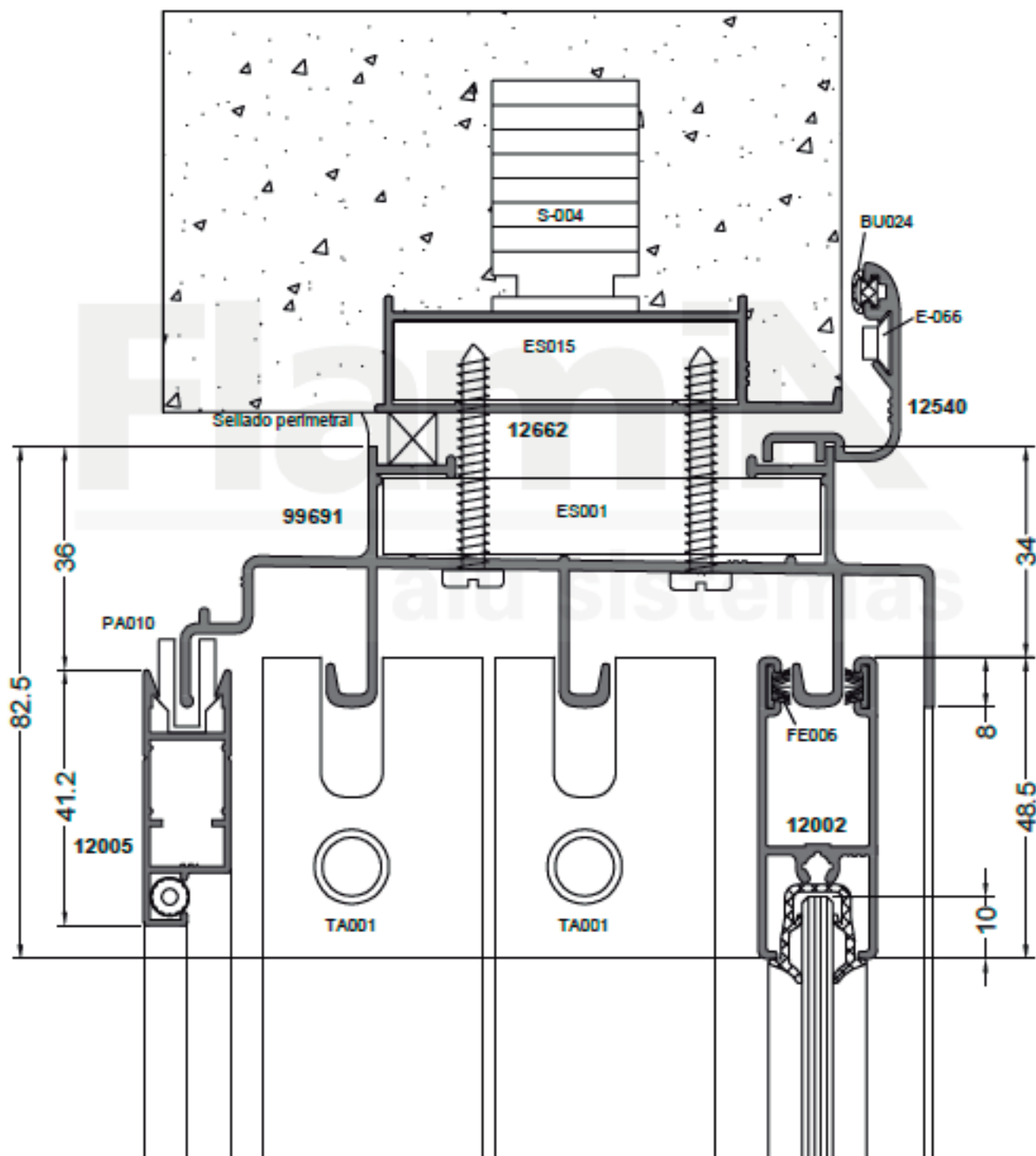
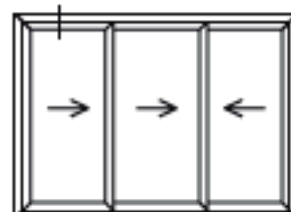

Corte horizontal ventana corrediza 2 hojas con marco 4 guías
 Hoja 12003.

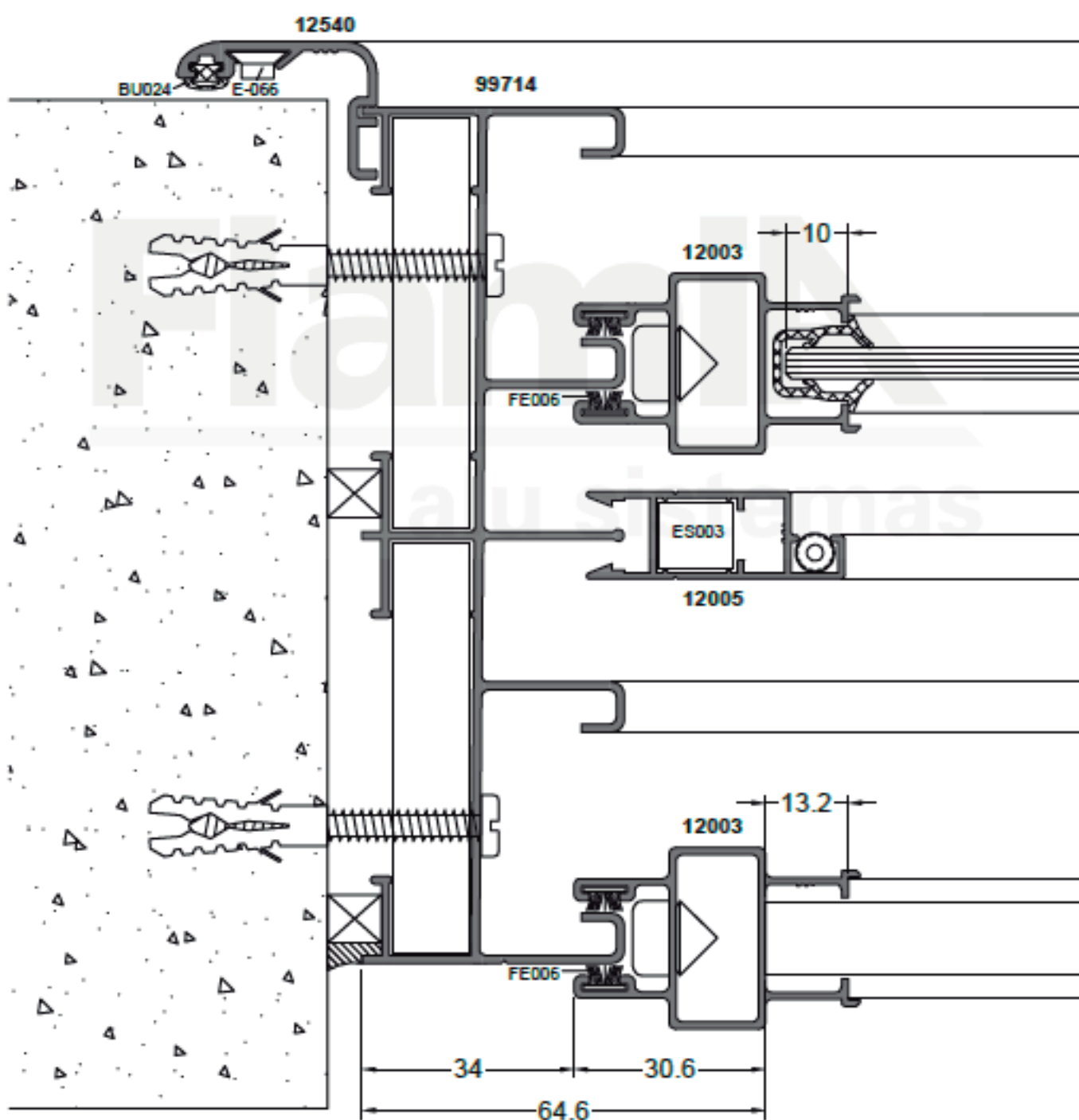
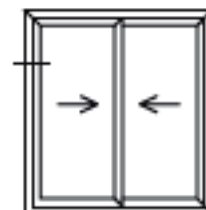

Corte horizontal ventana corrediza 2 hojas con marco 4 guías
 Hoja 12003.

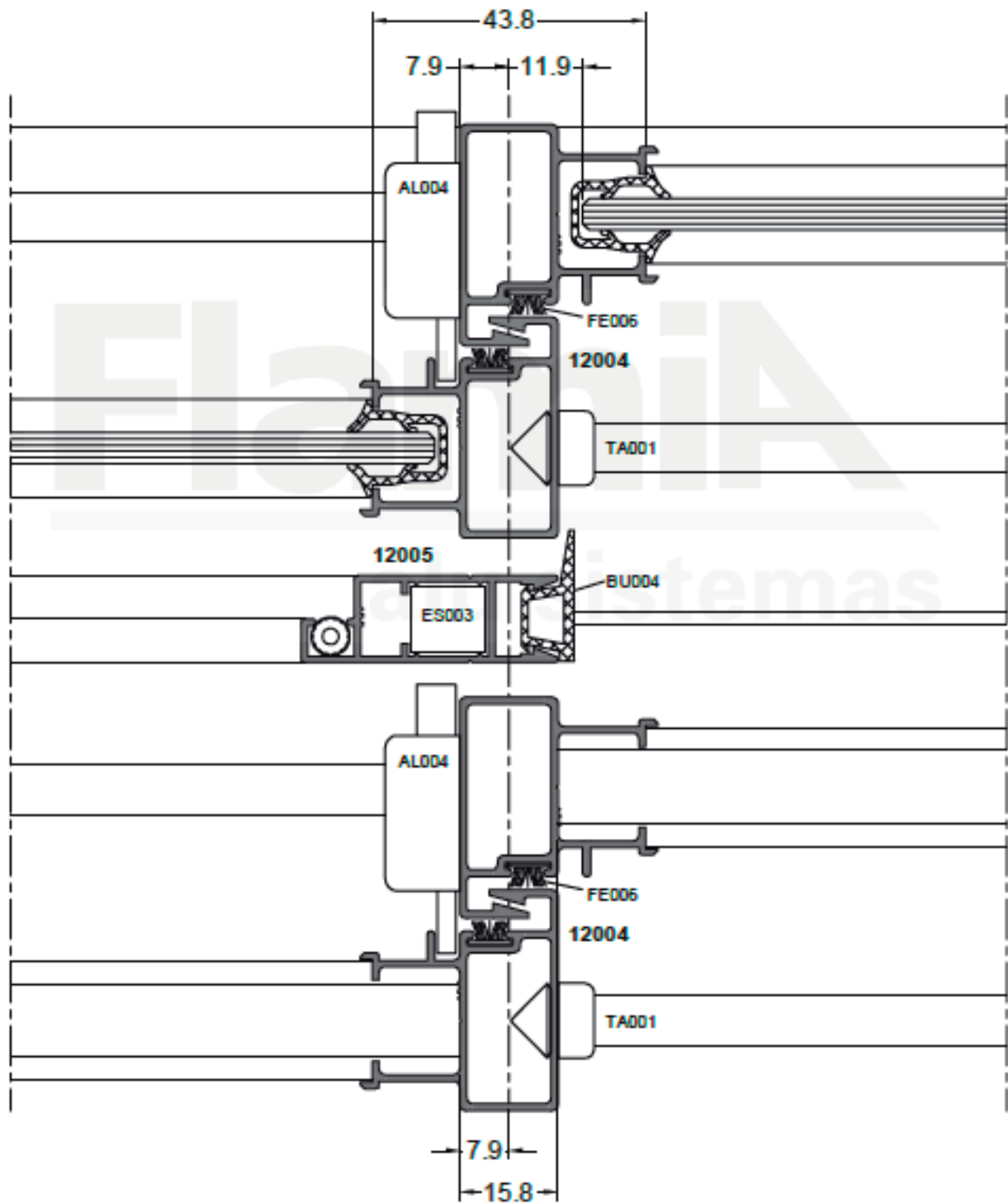
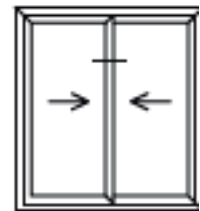

Corte horizontal ventana corrediza 2 hojas con marco 4 guías
 Hoja 12003.

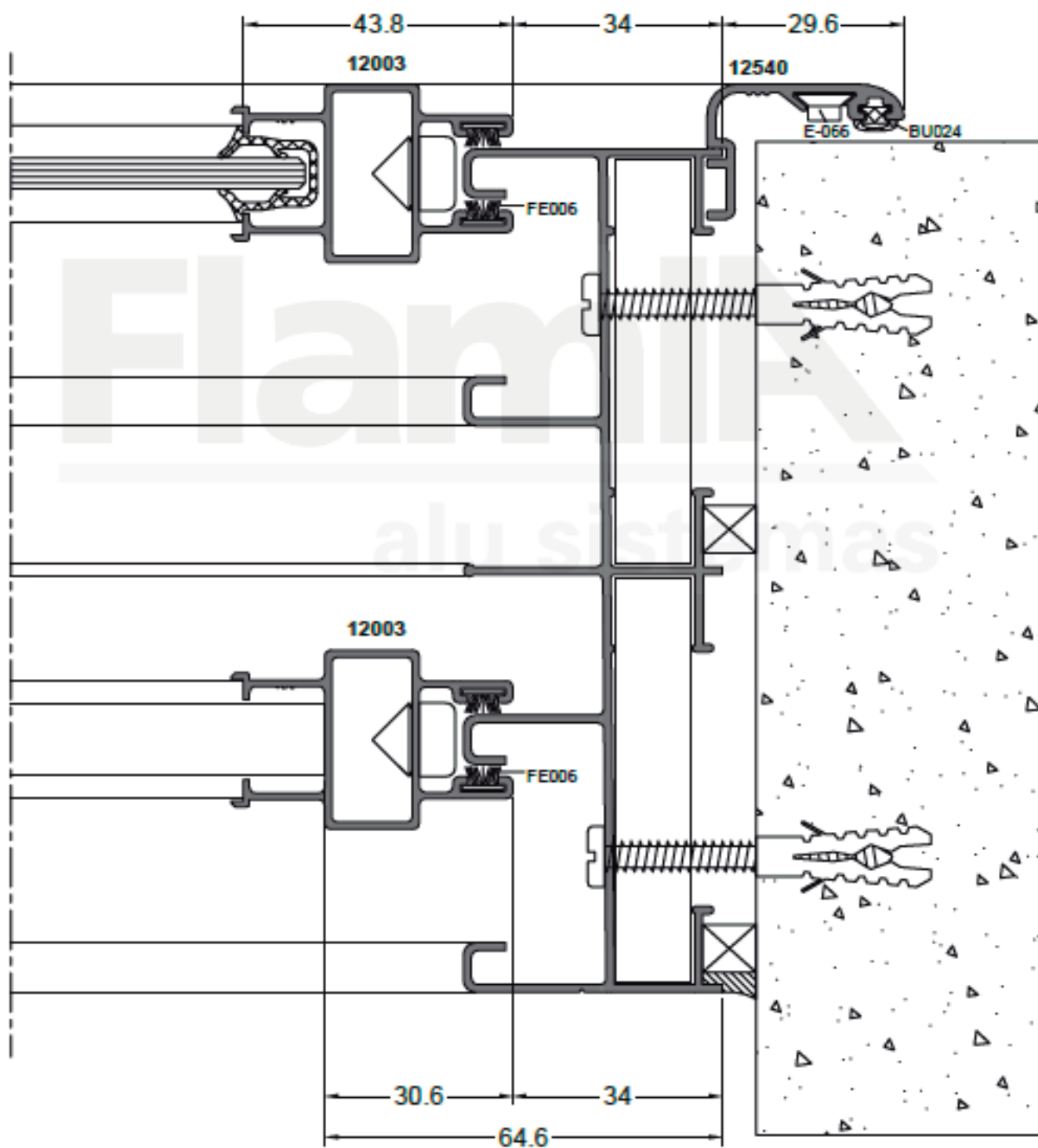
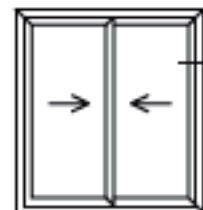

Corte vertical ventana corrediza 2 hojas con marco 4 guías
Hoja 12003.

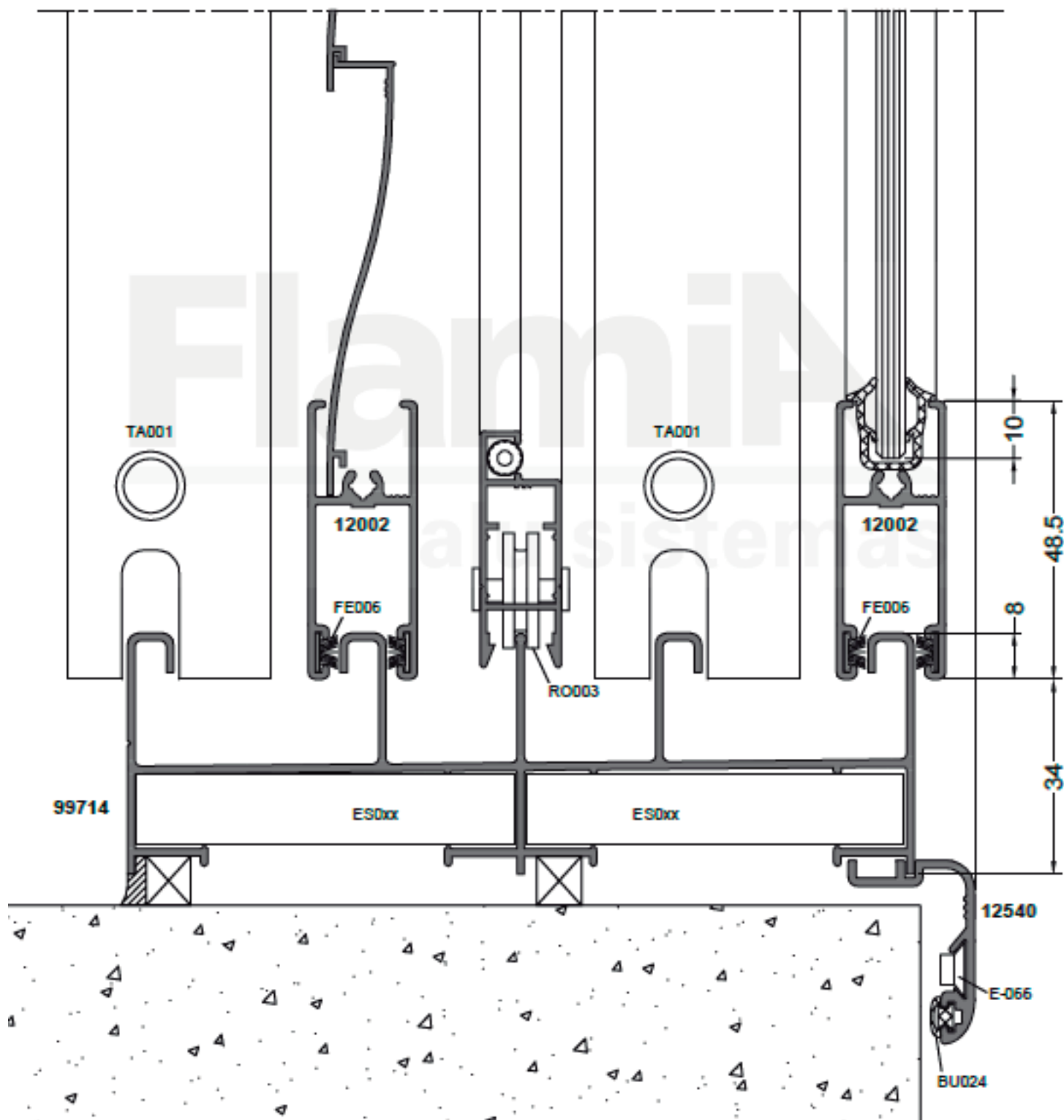
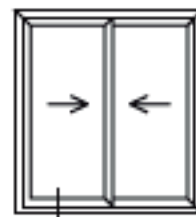

Corte vertical ventana corrediza 2 hojas con marco 4 guías
Hoja 12003.

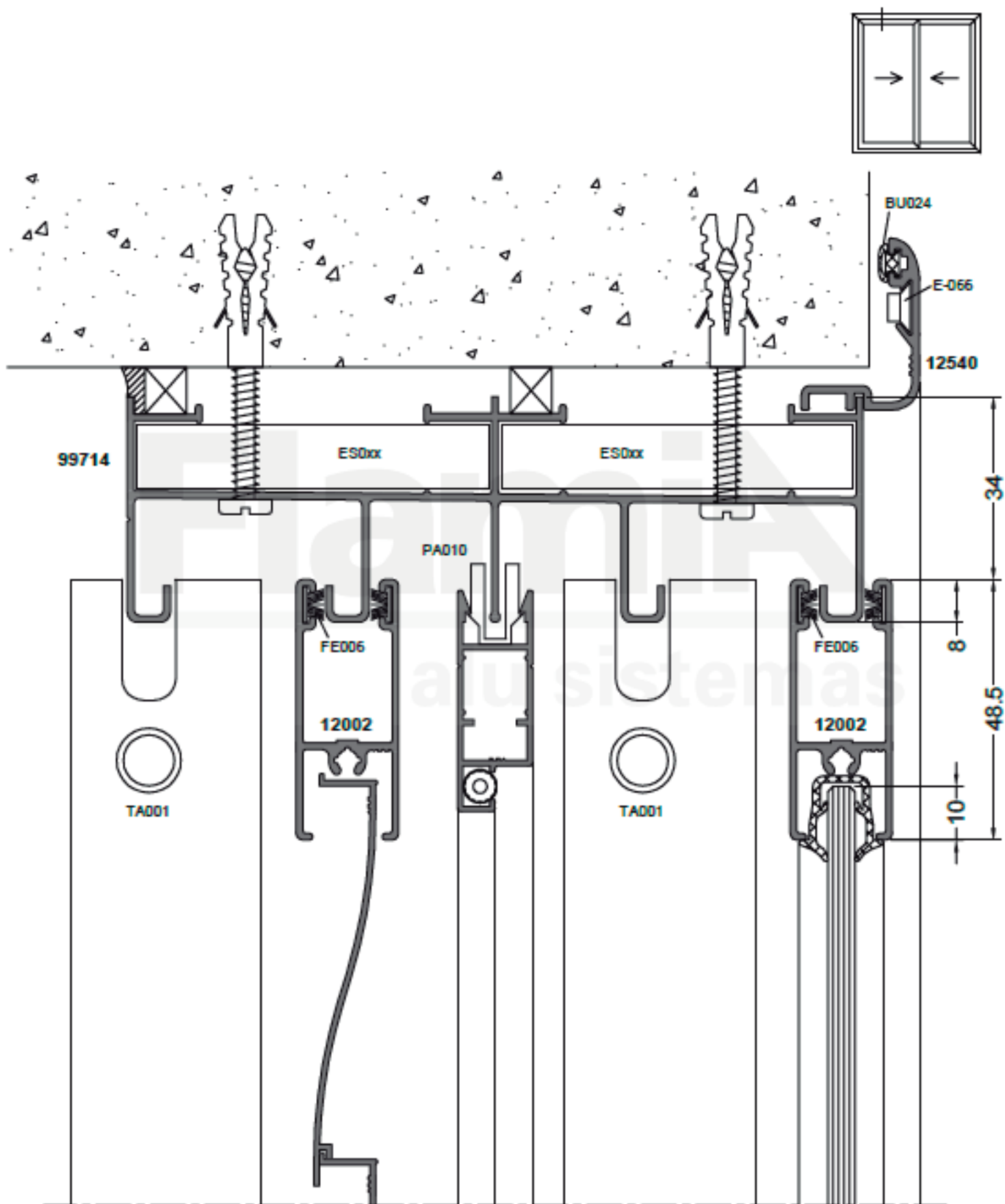

Corte horizontal ventana corrediza 2 con postigón Hoja 12003.

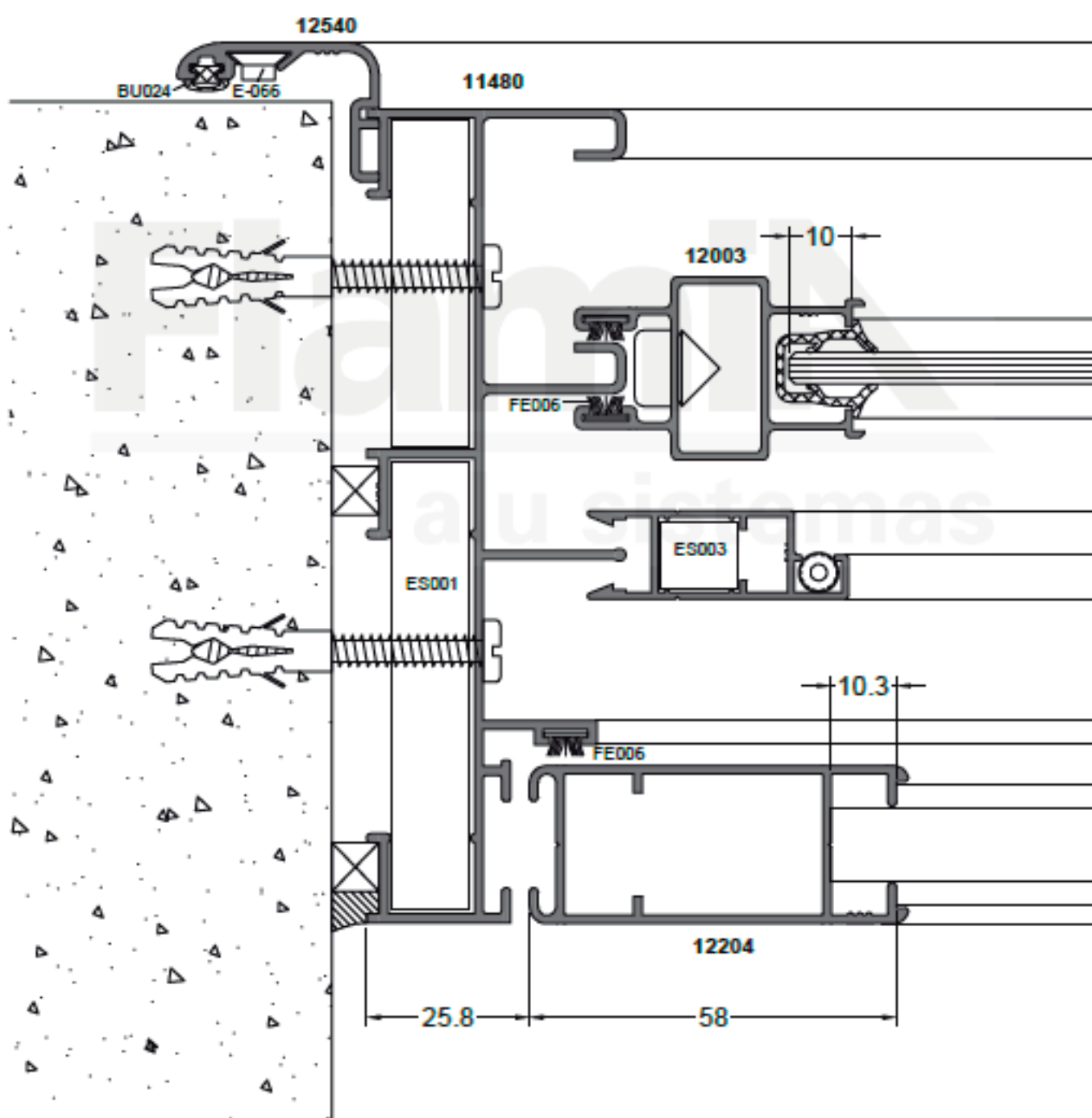
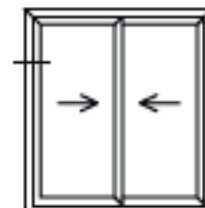

Corte horizontal ventana corrediza 2 con postigón
Hoja 12003.

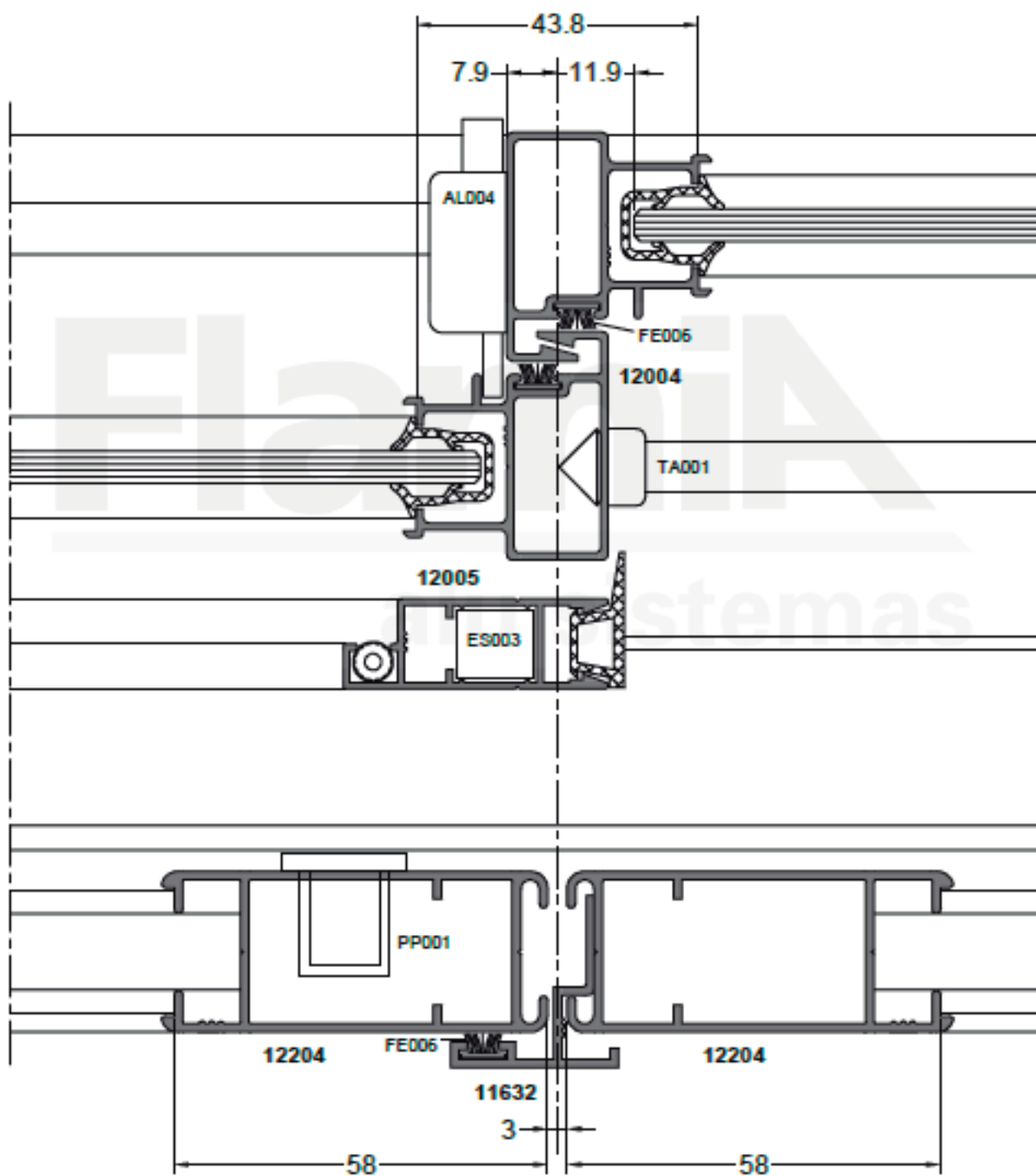
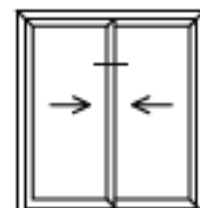

Corte horizontal ventana corrediza 2 con postigón
Hoja 12003.

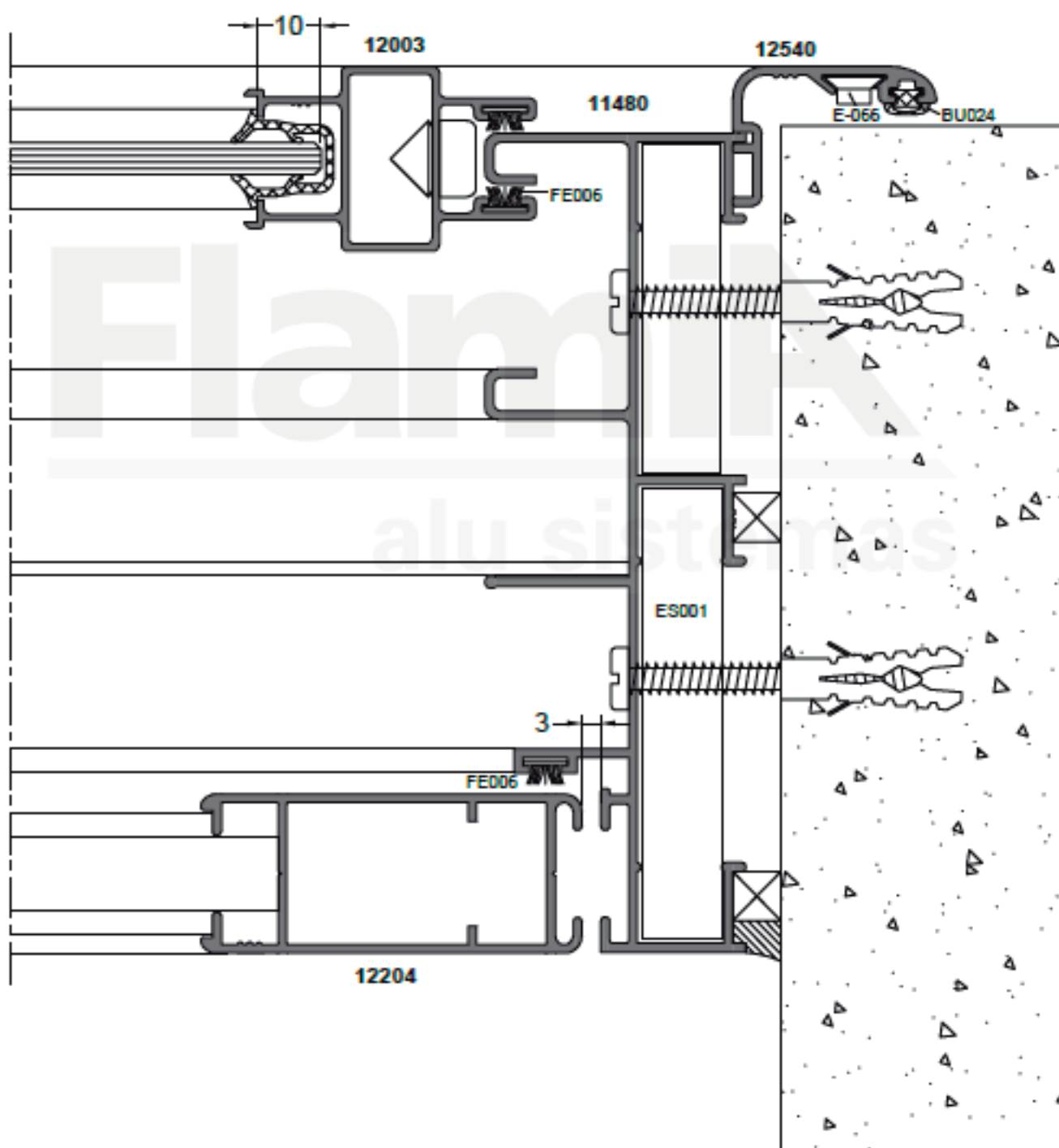
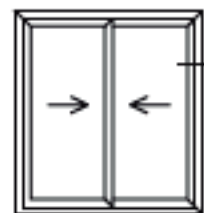

Corte vertical ventana corrediza 2 con postigón
Hoja 12003.

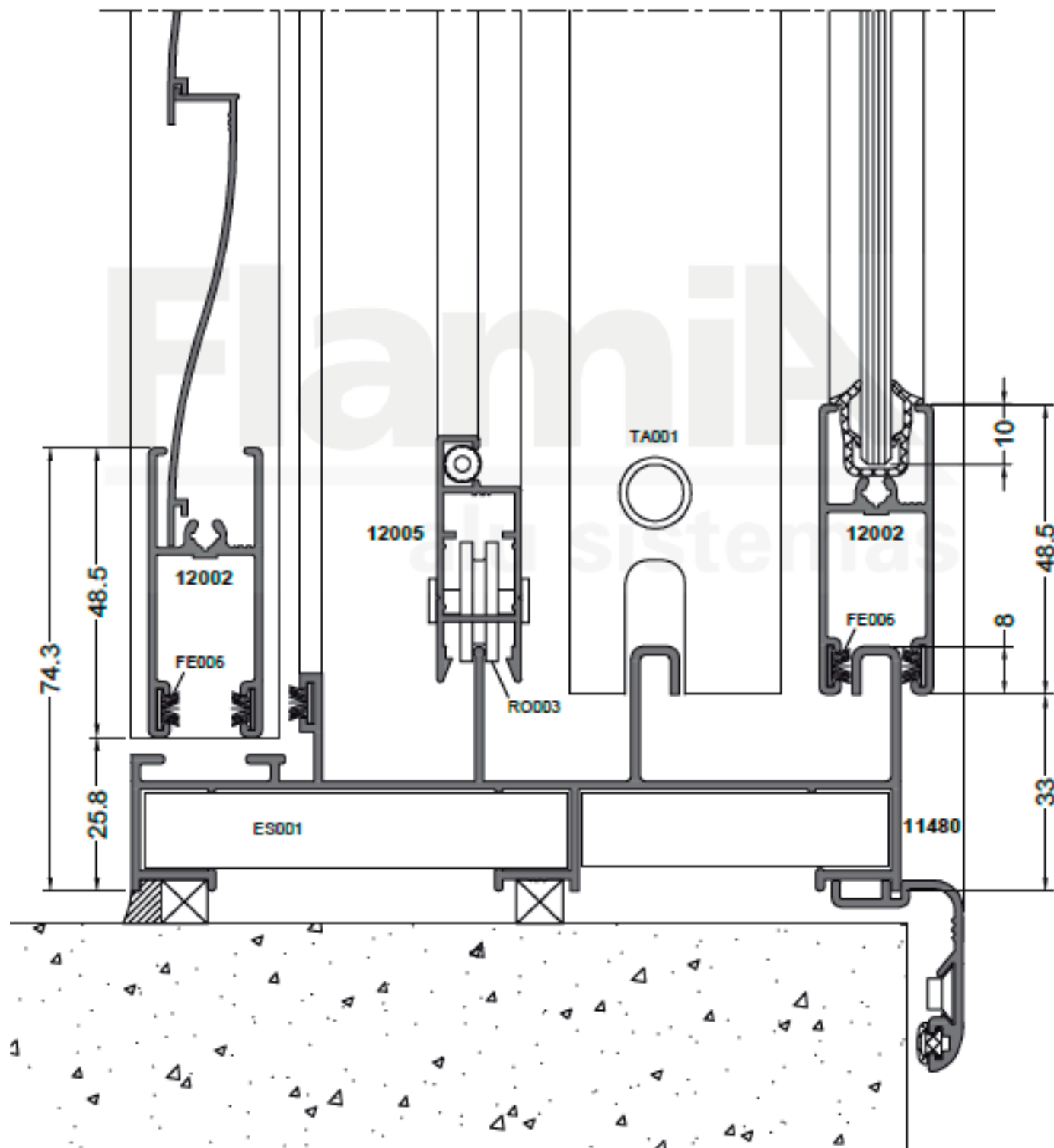
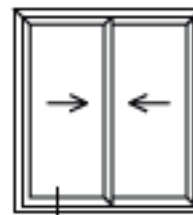

Corte vertical ventana corrediza 2 con postigón
Hoja 12003.

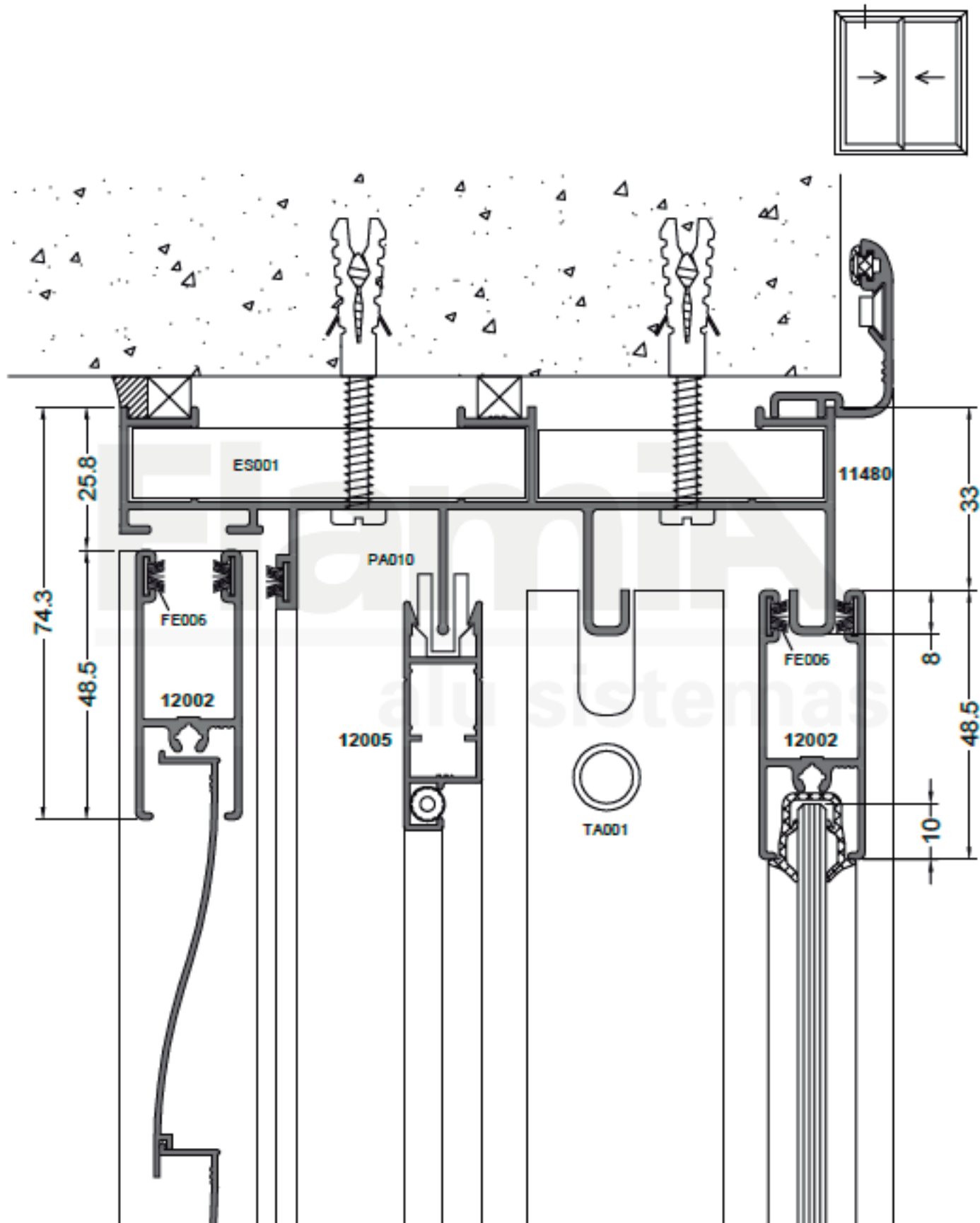





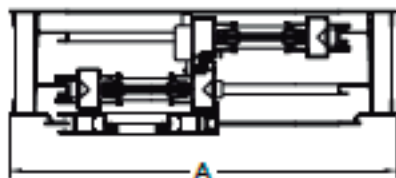



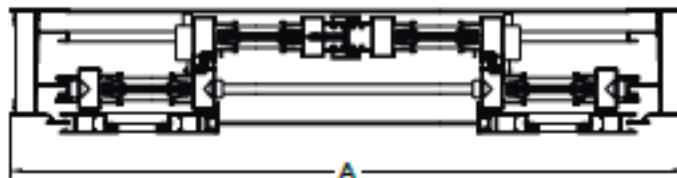







Listado de perfiles marco 2 guías

2 hojas



4 hojas



Código	Perfil	Descripción	Peso (kg/m)	Corte	2 hojas				4 hojas			
					Horizontal		Vertical		Horizontal		Vertical	
					Cant.	Medida	Cant.	Medida	Cant.	Medida	Cant.	Medida
17901		Marco	0.673		2	A	2	H	2	A	2	H
12002/ 99044		Zócalo	0.466/ 0.871		4	A/2-100			8	A/4-83		
12003		Parante lateral	0.489				2	H - 66			4	H - 66
12004		Parante central	0.448				2	H - 66			4	H - 66
17060		Encuentro central	0.341								1	H - 66
12005		Mosquitero	0.322		2	A/2-27	2	H - 76	2	A/4-12	2	H - 76
12662		Premarco	0.563		2	A + 48	2	H + 48	2	A + 48	2	H + 48
12540		Tapajunta	0.281		2	A + 59	2	H + 59	2	A + 59	2	H + 59





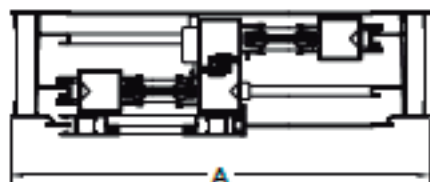







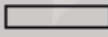

Listado de perfiles marco 2 guías

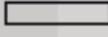
2 hojas

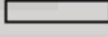

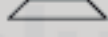
4 hojas

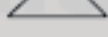





Código	Perfil	Descripción	Peso (kg/m)	Corte	2 hojas				4 hojas			
					Horizontal		Vertical		Horizontal		Vertical	
					Cant.	Medida	Cant.	Medida	Cant.	Medida	Cant.	Medida
17901		Marco	0.673		2	A	2	H	2	A	2	H
12002/ 99044		Zócalo	0.466/ 0.871		4	A/2-120			8	A/4-104		
99053		Parante lateral	0.712				2	H - 66			4	H - 66
99054		Parante central	0.700				2	H - 66			4	H - 66
17060		Encuentro central	0.341								1	H - 66
12005		Mosquitero	0.322		2	A/2-20	2	H - 76	2	A/4-4	2	H - 76
12662		Premarco	0.563		2	A + 48	2	H + 48	2	A + 48	2	H + 48
12540		Tapajunta	0.281		2	A + 59	2	H + 59	2	A + 59	2	H + 59

Listado de accesorios básicos para marco 2 guías

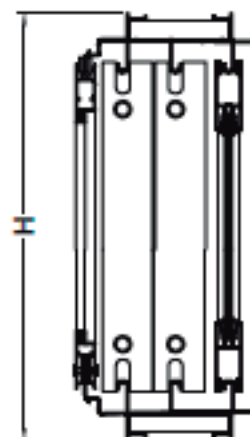
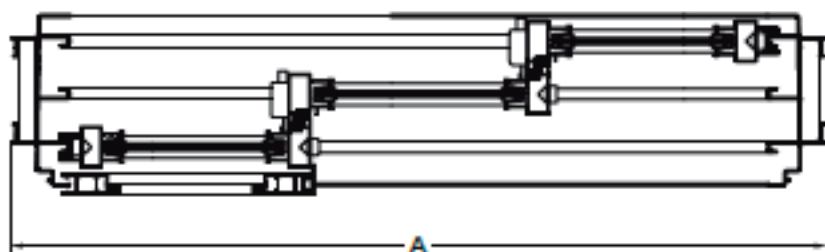
Código	Descripción	Cantidad	
		2 hojas	4 hojas
S-004	Grampa de amure (se coloca a 250 mm. de los extremos y luego cada 500 mm.)		
ES015	Escuadra premarco	4	
E-088	Escuadra de alineación tapajunta	4	
BU024	Burlite tapajunta	Ancho	2
		Alto	2
ES001	Escuadra para marco	4	
TA001	Tope de hoja	8	12
TA002	Antiruido parante central	8	12
AL004	Cierre central	1	2
RO008	Rueda simple	4	8
RO009	Rueda doble	4	8
RO017	Rueda simple regulable	4	8
RO018	Rueda doble regulable	4	8
FE008	Felpa 7x4.5 mm.	Ancho	4
		Alto	6
BU000 - BU001 - BU002	Burlite universal liviano - mediano - pesado	Ancho	2
		Alto	4
ES003	Escuadra mosquitero	4	4
RO003	Rueda mosquitero	2	2
PA010	Patín mosquitero superior	2	2
BU004	Burlite tope mosquitero	Alto	1
CU001	Cuerda mosquitero	Ancho	1
		Alto	2
TE010 - 17	Tela mosquitero	Ancho	1/2
		Alto	1

Listado de perfiles marco 3 guías











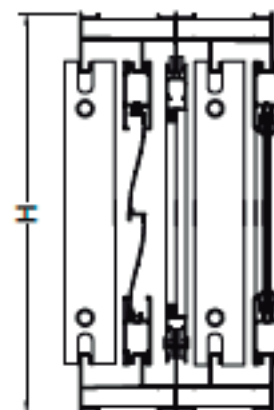
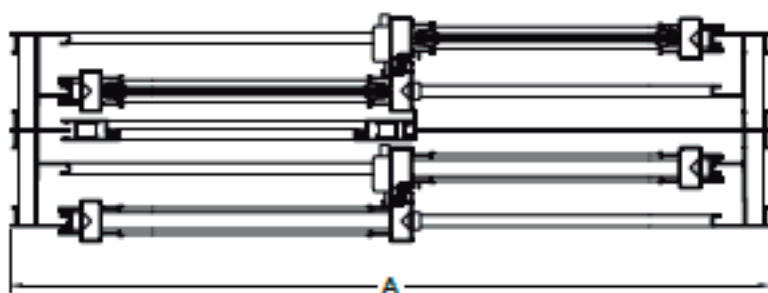





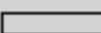

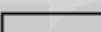

Código	Perfil	Descripción	Peso (kg/m)	Corte	3 hojas			
					Horizontal		Vertical	
					Cant.	Medida	Cant.	Medida
99691		Marco 3 guías	1.369		2	A	2	H
12002/ 99044		Zócalo	0.466/ 0.871		6	A/3-81		
12003		Parante lateral	0.489				2	H - 66
12004		Parante central	0.448				4	H - 66
12005		Mosquitero	0.322		2	A/3-10	2	H - 76
99691		Marco 3 guías	1.369		2	A	2	H
12002/ 99044		Zócalo	0.466/ 0.871		6	A/3-100		
99053		Parante lateral	0.712				2	H - 66
99054		Parante central	0.700				4	H - 66
12005		Mosquitero	0.322		2	A/3	2	H - 76
12662		Premarco	0.563		2	A + 48	2	H + 48
12540		Tapajunta	0.281		2	A + 59	2	H + 59

Listado de accesorios básicos para marco 3 guías

Código	Descripción	Cantidad	
S-004	Grampa de amure (se coloca a 250 mm. de los extremos y luego cada 500 mm.)		
ES015	Escuadra premarco	4	
E-088	Escuadra de alineación tapajunta	4	
BU024	Burlite tapajunta	Ancho	2
		Alto	2
ES001	Escuadra para marco	4	
TA001	Tope de hoja	12	
TA002	Antiruido parante central	12	
TA005	Bajo cruce de hojas	2	
AL004	Cierre central	2	
RO008	Rueda simple	6	
RO009	Rueda doble	6	
RO017	Rueda simple regulable	6	
RO018	Rueda doble regulable	6	
FE006	Felpa 7x4.5 mm.	Ancho	4
		Alto	8
BU000 - BU001 - BU002	Burlite universal liviano - mediano - pesado	Ancho	2
		Alto	4
ES003	Escuadra mosquitero	4	
RO003	Rueda mosquitero	2	
PA010	Patín mosquitero superior	2	
BU004	Burlite tope mosquitero	Alto	1
CU001	Cuerda mosquitero	Ancho	1
		Alto	2
TE010 - 17	Tela mosquitero	Ancho	1/3
		Alto	1

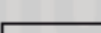
Listado de perfiles marco 4 guías











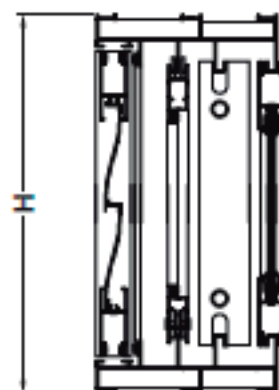
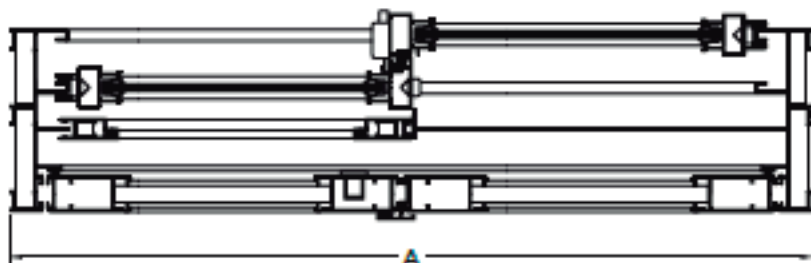



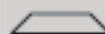









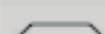

Código	Perfil	Descripción	Peso (kg/m)	Corte	2 hojas				4 hojas			
					Horizontal		Vertical		Horizontal		Vertical	
					Cant.	Medida	Cant.	Medida	Cant.	Medida	Cant.	Medida
99714		Marco	1.409		2	A	2	H	2	A	2	H
12002/ 99044		Zócalo	0.466/ 0.871		8	A/2-100			16	A/4-83		
12003		Parante lateral	0.489				4	H - 66			8	H - 66
12004		Parante central	0.448				4	H - 66			8	H - 66
17060		Encuentro central	0.341								1	H - 66
12005		Mosquitero	0.322		2	A/2-27	2	H - 76	2	A/4-12	2	H - 76
12152/ 12351		Tablilla 77 mm.	0.248			A/2-73				A/4-58		
11192/ 11199		Tablilla 68 mm.	0.272			A/2-73				A/4-58		
12540		Tapajunta	0.281		2	A + 59	2	H + 59	2	A + 59	2	H + 59

Listado de accesorios básicos para marco 4 guías

Código	Descripción	Cantidad	
		2 hojas	4 hojas
E-066	Escuadra de alineación tapajunta	4	
BU024	Burlete tapajunta	Ancho	2
		Alto	2
17066	Perfil para escuadra para marco	8	
TA001	Tope de hoja	16	26
TA002	Antiruido parante central	16	26
TA005	Bajo cruce de hojas	2	4
AL004	Cierre central	2	4
RO008	Rueda simple	8	16
RO009	Rueda doble	8	16
RO017	Rueda simple regulable	8	16
RO018	Rueda doble regulable	8	16
FE006	Felpa 7x4.5 mm.	Ancho	8
		Alto	12
BU000 - BU001 - BU002	Burlete universal liviano - mediano - pesado	Ancho	2
		Alto	4
ES003	Escuadra mosquitero	4	4
RO003	Rueda mosquitero	2	2
PA010	Patín mosquitero superior	2	2
BU004	Burlete tope mosquitero	Alto	1
CU001	Cuerda mosquitero	Ancho	1/2
		Alto	2
TE010 - 17	Tela mosquitero	Ancho	1/2
		Alto	1

Listado de perfiles marco 2 guías con postigón



Código	Perfil	Descripción	Peso (kg/m)	Corte	2 hojas			
					Horizontal		Vertical	
					Cant.	Medida	Cant.	Medida
11480		Marco	1.332		2	A	2	H
12002/ 99044		Zócalo para corrediza	0.488 / 0.871		4	A/2-100		
12003		Parante lateral	0.489				2	H - 68
12004		Parante central	0.448				2	H - 68
17080		Encuentro central	0.341					
12005		Mosquitero	0.322		2	A/2-27	2	H - 76
12204		Hoja postigón	0.688				4	H - 52
10812/ 99044		Zócalo para postigón	0.393 / 0.871		4	A/2-144		
11632		Encuentro de hojas					1	H - 52
12152/ 12351		Tablilla 77 mm.	0.248			A/2-130		
11192/ 11199		Tablilla 68 mm.	0.272			A/2-130		
12540		Tapajunta	0.281		2	A + 59	2	H + 59

Listado de accesorios básicos para marco 2 guías con postigón

Código	Descripción	Cantidad	
E-066	Escuadra de alineación tapajunta	4	
BU024	Burlate tapajunta	Ancho	2
		Alto	2
ES001	Escuadra para marco	4	
TA001	Tope de hoja	8	
TA002	Antiruido parante central	8	
TA005	Bajo cruce de hojas	2	
AL004	Cierre central	1	
RO008	Rueda simple	4	
RO009	Rueda doble	4	
RO017	Rueda simple regulable	4	
RO018	Rueda doble regulable	4	
FE006	Felpa 7x4.5 mm.	Ancho	6
		Alto	9
BU000 - BU001 - BU002	Burlate universal liviano - mediano - pesado	Ancho	2
		Alto	4
BI012/BI013	Bisagra para postigón Natural/Blanco/Negro	4	
BI016/BI017	Bisagra para postigón cilíndrica Natural/Blanco/Negro	4	
PP001	Pasador a palanca con varilla corta (200 mm.)	1	
PP002	Pasador a palanca con varilla larga (600 mm.)	1	
PP003	Pasador GM doble	1	
ES003	Escuadra mosquitero	4	
RO003	Rueda mosquitero	2	
PA010	Patín mosquitero superior	2	
BU004	Burlate tope mosquitero	Alto	1
CU001	Cuerda mosquitero	Ancho	1/2
		Alto	2
TE010 - 17	Tela mosquitero	Ancho	1/2
		Alto	1

SISTEMAS DE CARPINTERIA

Standard

PAÑO FIJO



Corte horizontal paño fijo.
Marco 99007.

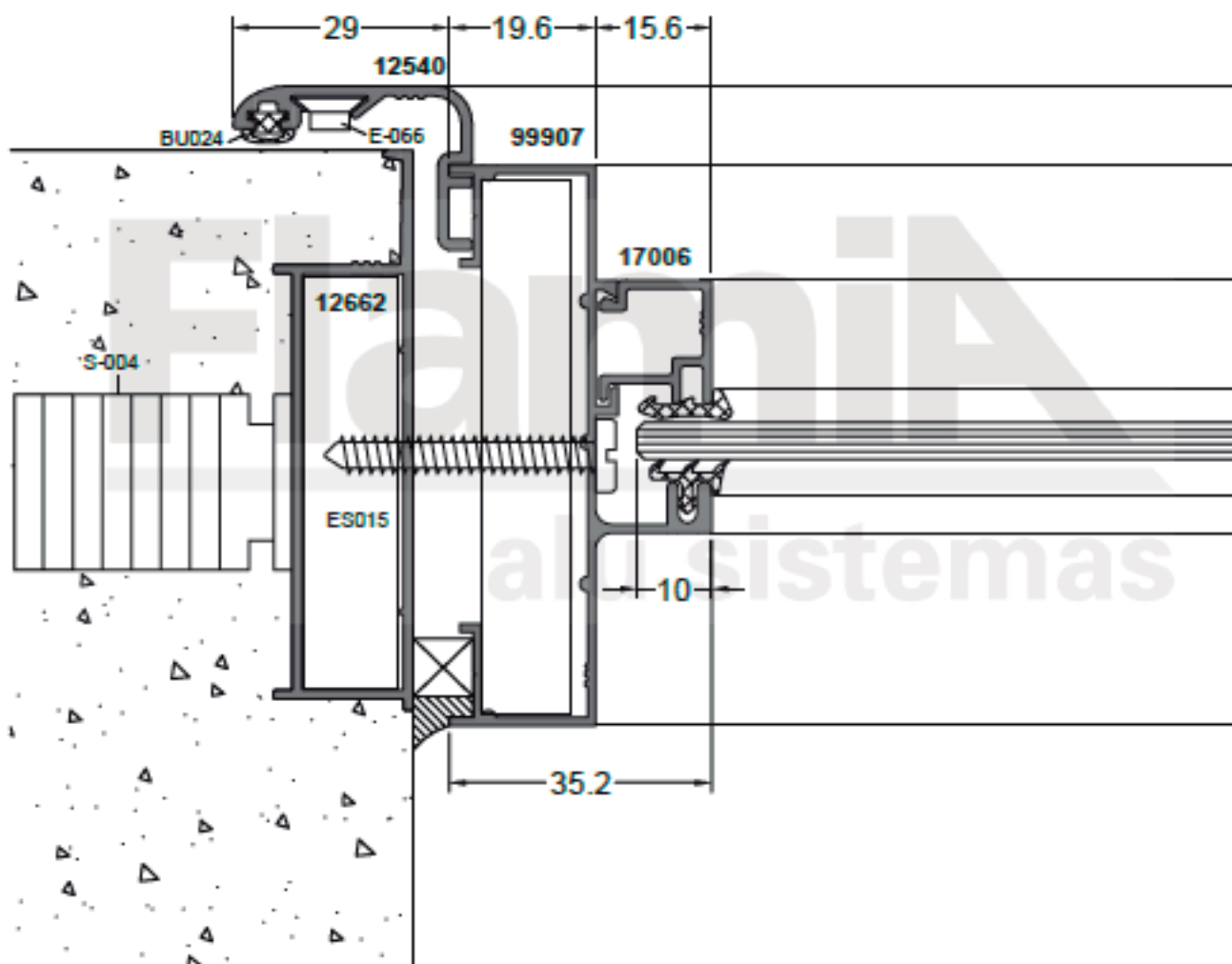

Corte horizontal paño fijo.
Marco 10329.

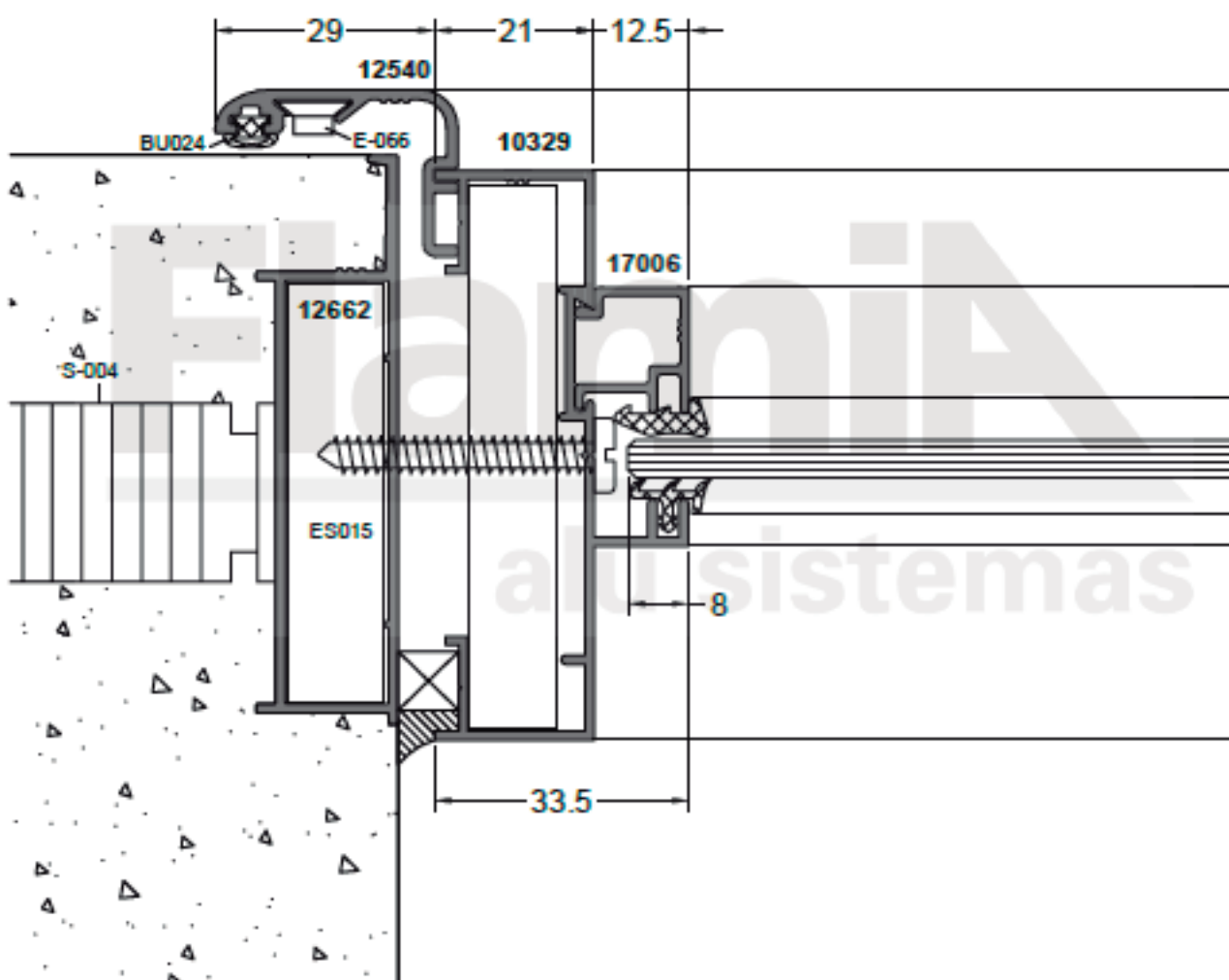

Corte vertical paño fijo.
Marco 99007.

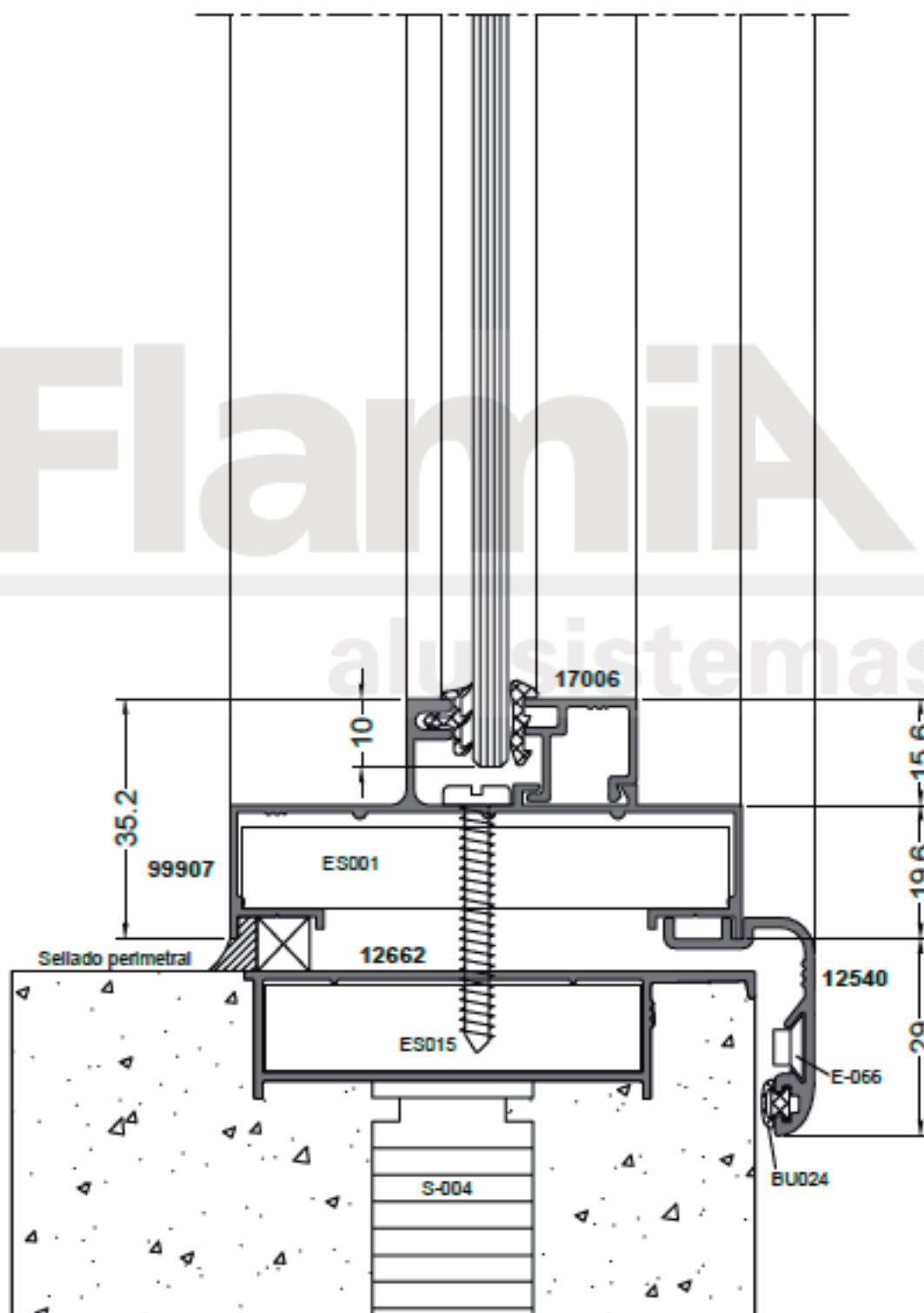

Corte vertical paño fijo.
Marco 10329.

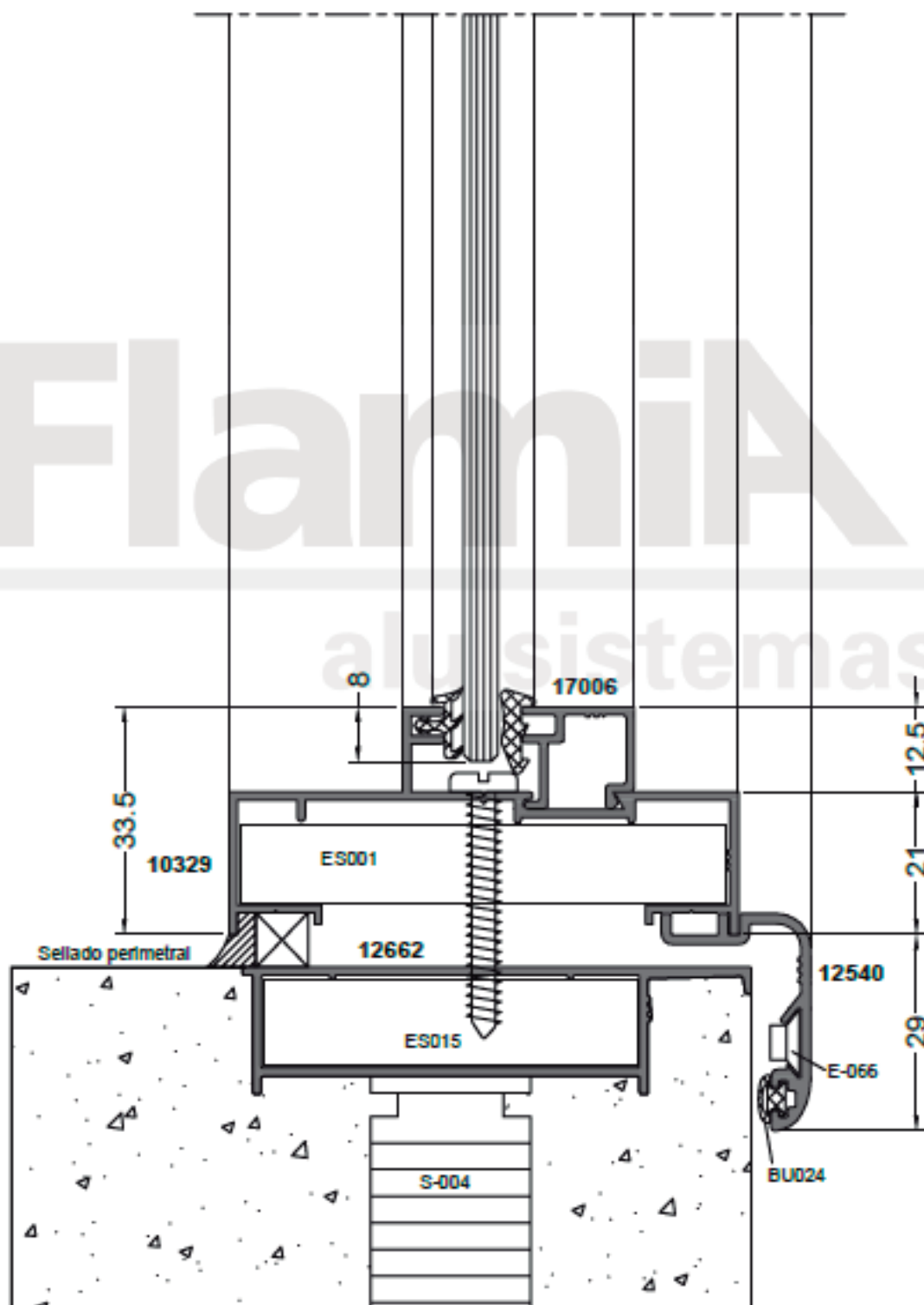

Corte horizontal paño fijo con travesaño.
Marco 99007.

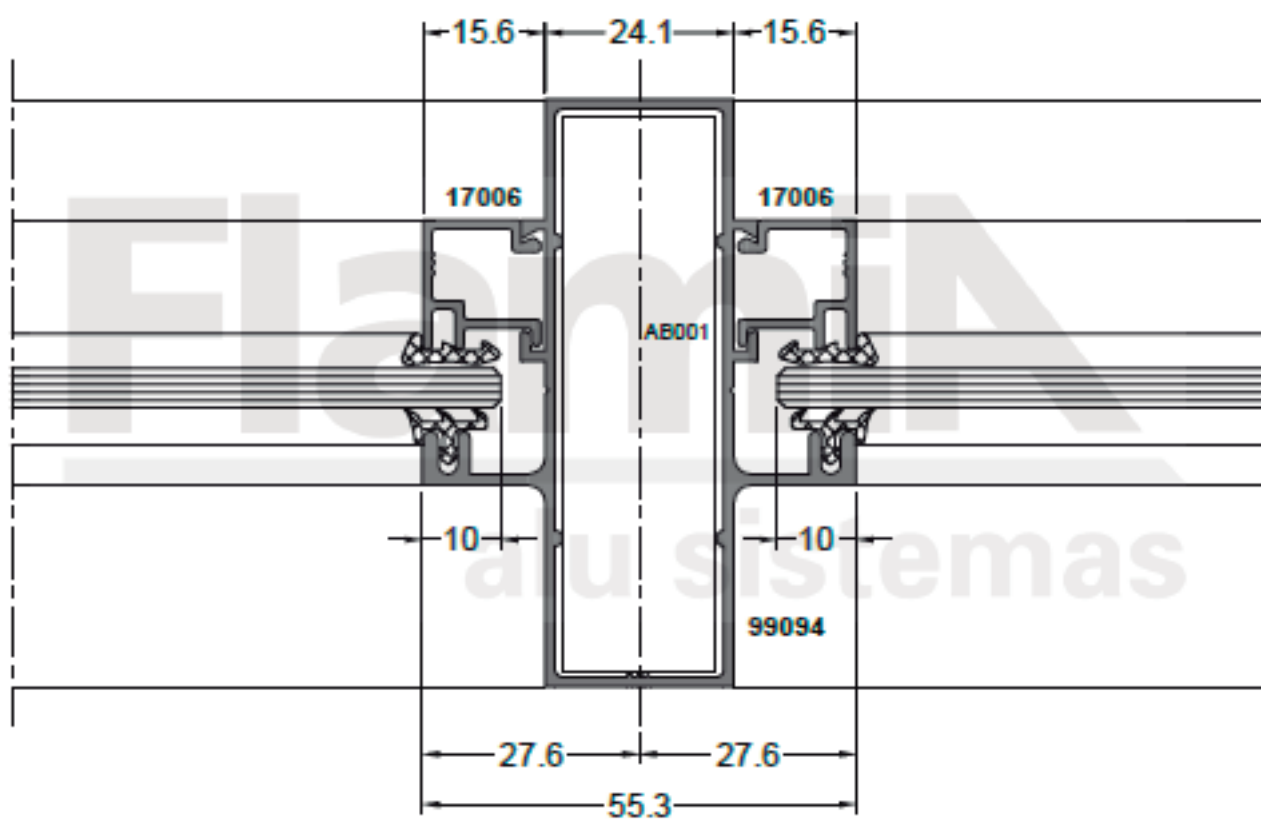
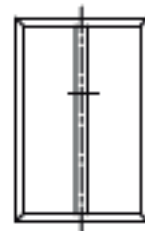

Corte horizontal paño fijo con travesaño.
Marco 10329.

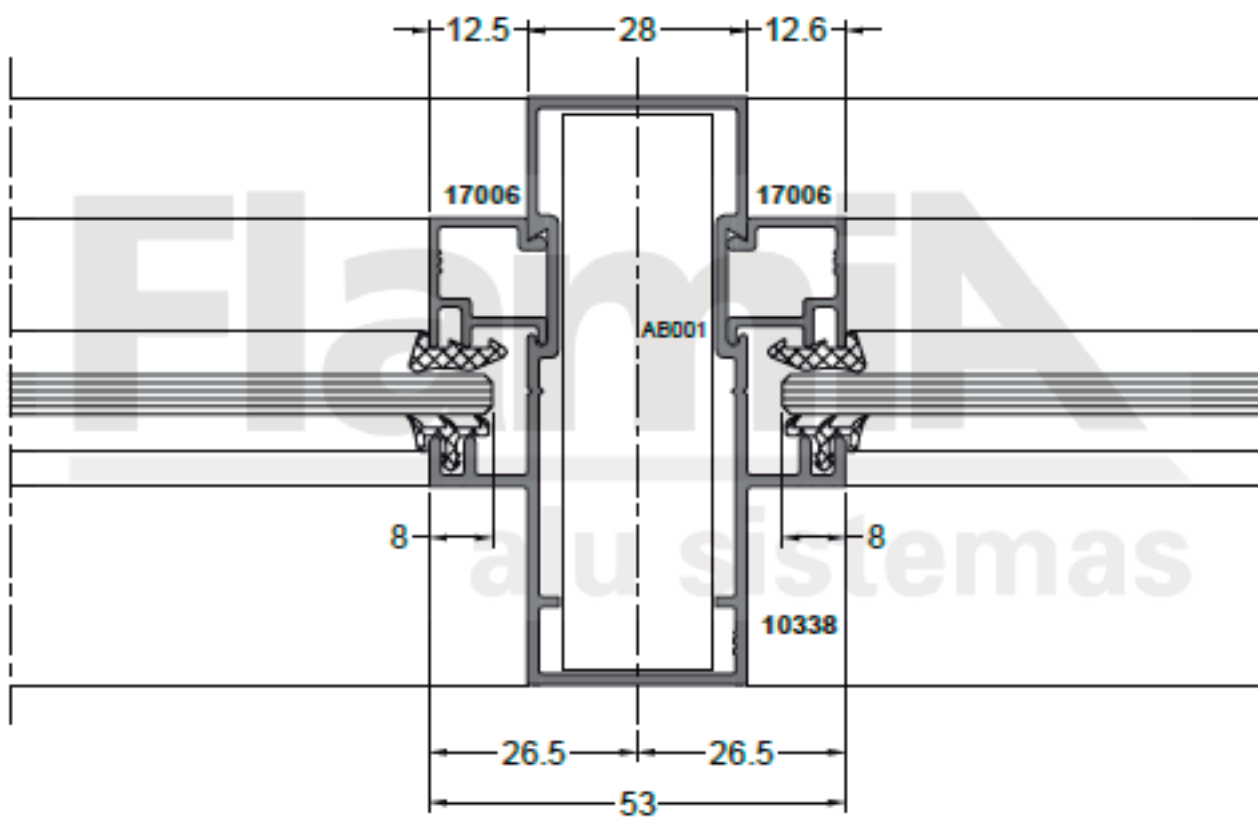
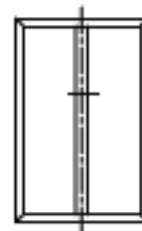

Corte vertical paño fijo con travesaño.
Marco 99007.

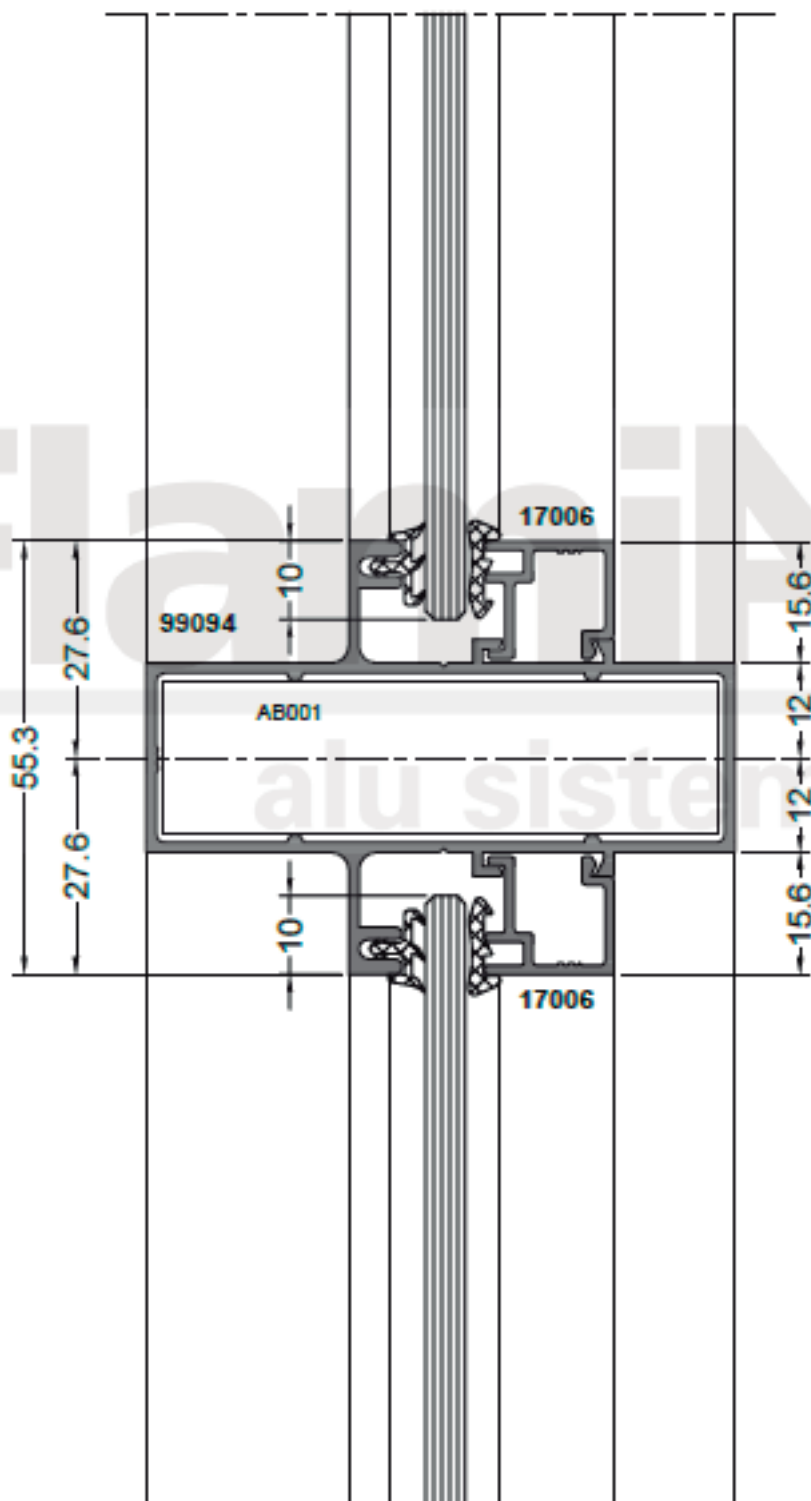
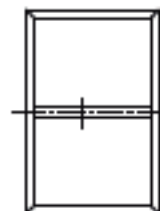



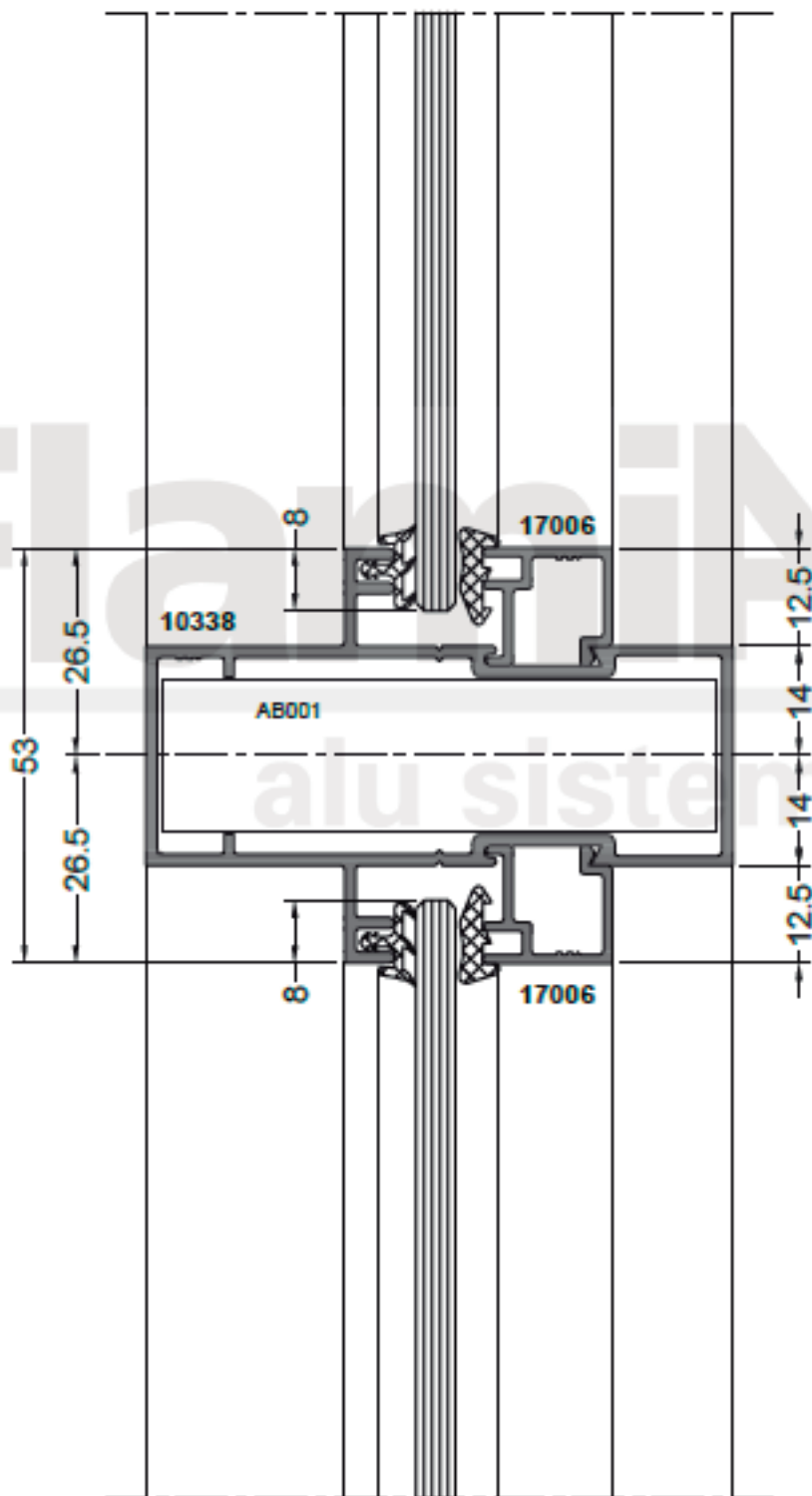



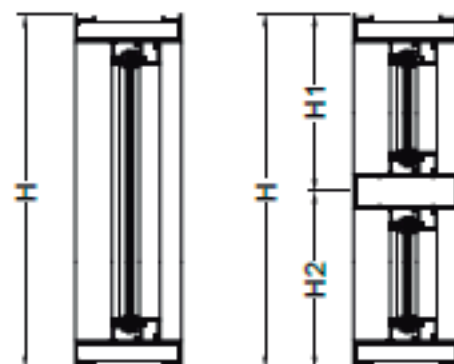
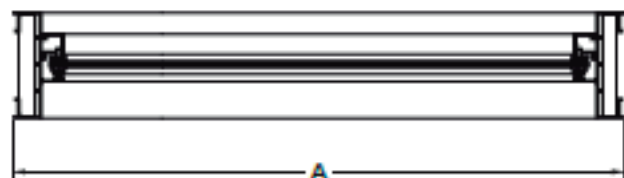





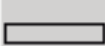
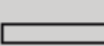

Corte vertical paño fijo con travesaño.
Marco 10329.

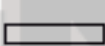
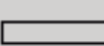

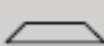
Listado de perfiles (Marco 99907)

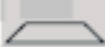

Código	Perfil	Descripción	Peso (kg/m)	Horizontal			Vertical		
				Cantidad	Medida	Corte	Cantidad	Medida	Corte
99907		Marco	0.558	2	A		2	H	
17008		Contravidrio	0.170	2	A - 40		2	H - 71	
99094		Travesaño	0.978	1	A - 40				
17008		Contravidrio	0.170	4	A - 40		4	H1-63 H2-63	
12862		Premarco	0.563	2	A + 48		2	H + 48	
12540		Tapajunta	0.281	2	A + 50		2	H + 50	





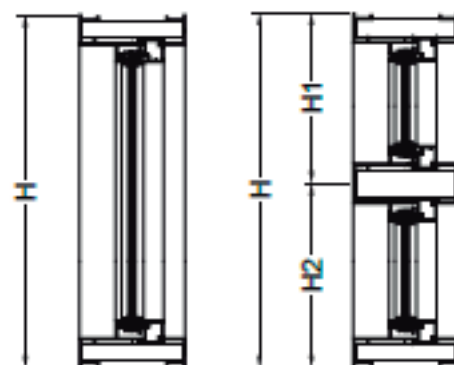
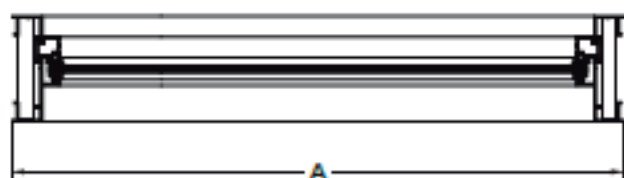

Listado de accesorios

Código	Descripción	Cantidad	
S-004	Grampa de amure (se coloca a 250 mm. de los extremos y luego cada 500 mm.)		
ES015	Escuadra premarco	4	
E-088	Escuadra de alineación tapajunta	4	
BU024	Burlete tapajunta	Ancho	2
		Alto	2
ES001	Escuadra para marco	4	
AB001	Unión travesaño	8	
BU007	Burlete exterior vidrio	Ancho	2
		Alto	2
BU008 - BU009 - BU010	Burlete cuña chica - mediana - grande	Ancho	2
		Alto	2

**FORMULA DE CORTE VALIDA UNICAMENTE PARA LA CONSTRUCCION DE UN PROTOTIPO.
NO APTA PARA PRODUCCION DE ABERTURAS**

Listado de perfiles (Marco 10329)



Código	Perfil	Descripción	Peso (kg/m)	Horizontal			Vertical		
				Cantidad	Medida	Corte	Cantidad	Medida	Corte
10329		Marco	0.566	2	A		2	H	
17006		Contravidrio	0.170	2	A - 42		2	H - 67	
10338		Travesaño	0.998	1	A - 40				
17006		Contravidrio	0.170	4	A - 40		4	H1-60 H2-60	
12662		Premarco	0.563	2	A + 48		2	H + 48	
12540		Tapajunta	0.281	2	A + 59		2	H + 59	

Listado de accesorios

Código	Descripción	Cantidad	
S-004	Grampa de amure (se coloca a 250 mm. de los extremos y luego cada 500 mm.)		
ES015	Escuadra premarco	4	
E-066	Escuadra de alineación tapajunta	4	
BU024	Burlate tapajunta	Ancho	2
		Alto	2
ES001	Escuadra para marco	4	
AB001	Unión travesaño	8	
BU007	Burlate exterior vidrio	Ancho	2
		Alto	2
BU008 - BU009 - BU010	Burlate cuña chica - mediana - grande	Ancho	2
		Alto	2

FORMULA DE CORTE VALIDA UNICAMENTE PARA LA CONSTRUCCION DE UN PROTOTIPO.
NO APTA PARA PRODUCCION DE ABERTURAS

SISTEMAS DE CARPINTERIA

Standard

PUERTA DE ABRIR



Corte horizontal puerta de abrir 1 y 2 hojas.
 Hoja 11577 y marco 11776.

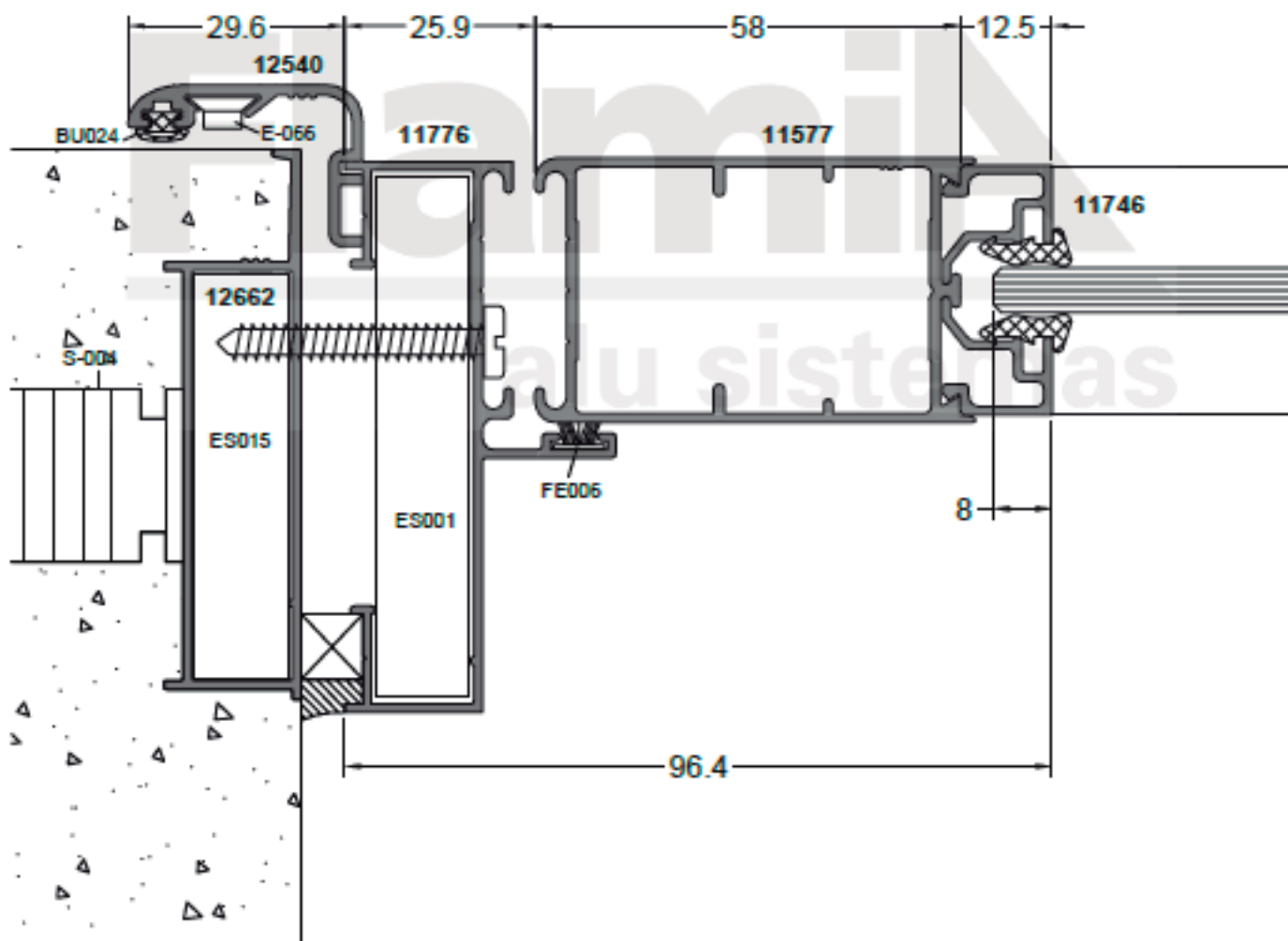
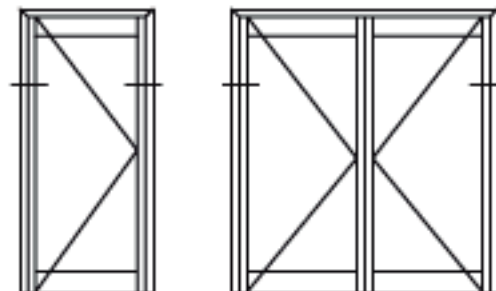

Corte horizontal puerta de abrir 2 hojas.
Hoja 11577 y marco 11776.

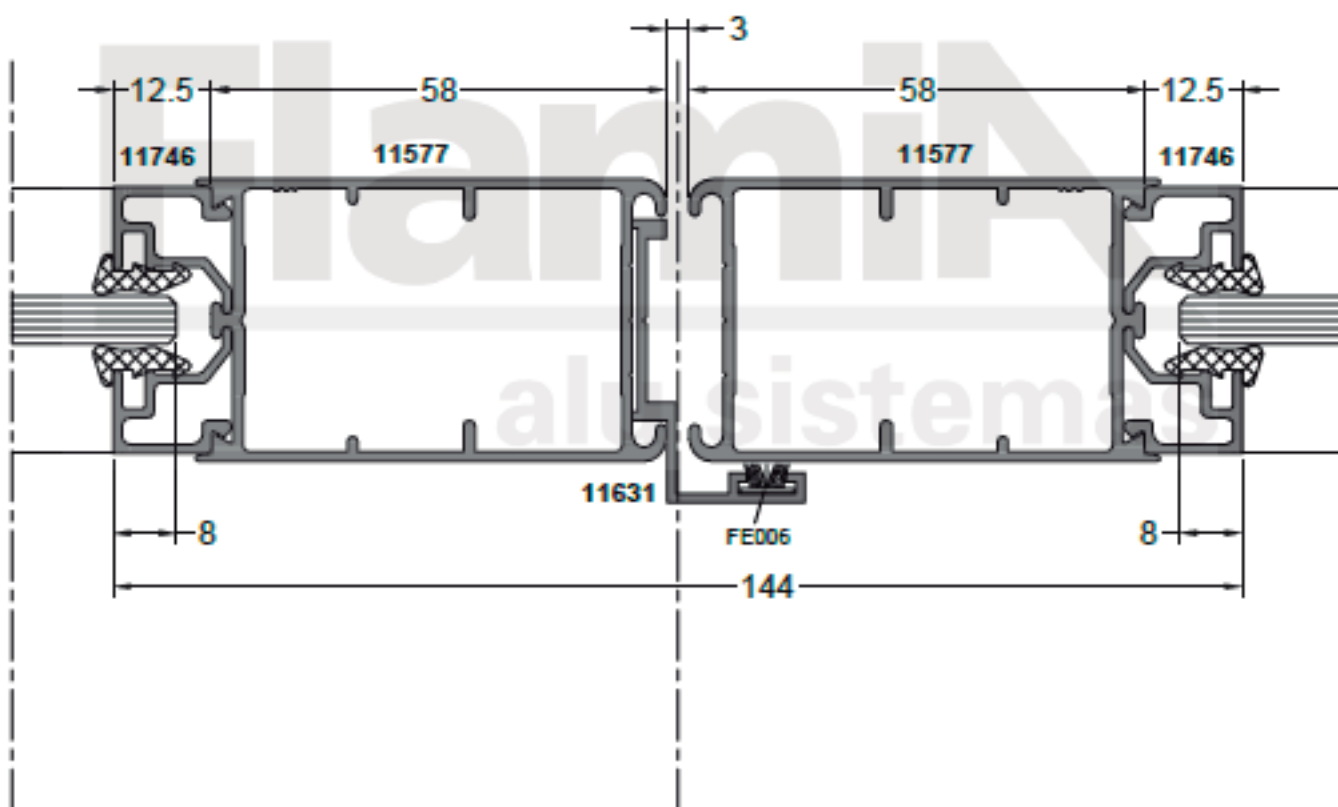
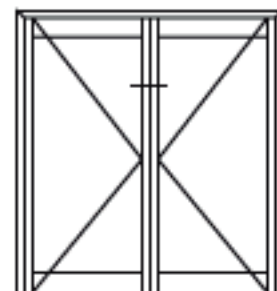

Corte vertical puerta de abrir 1 y 2 hojas.
Hoja 11577 y marco 11776.

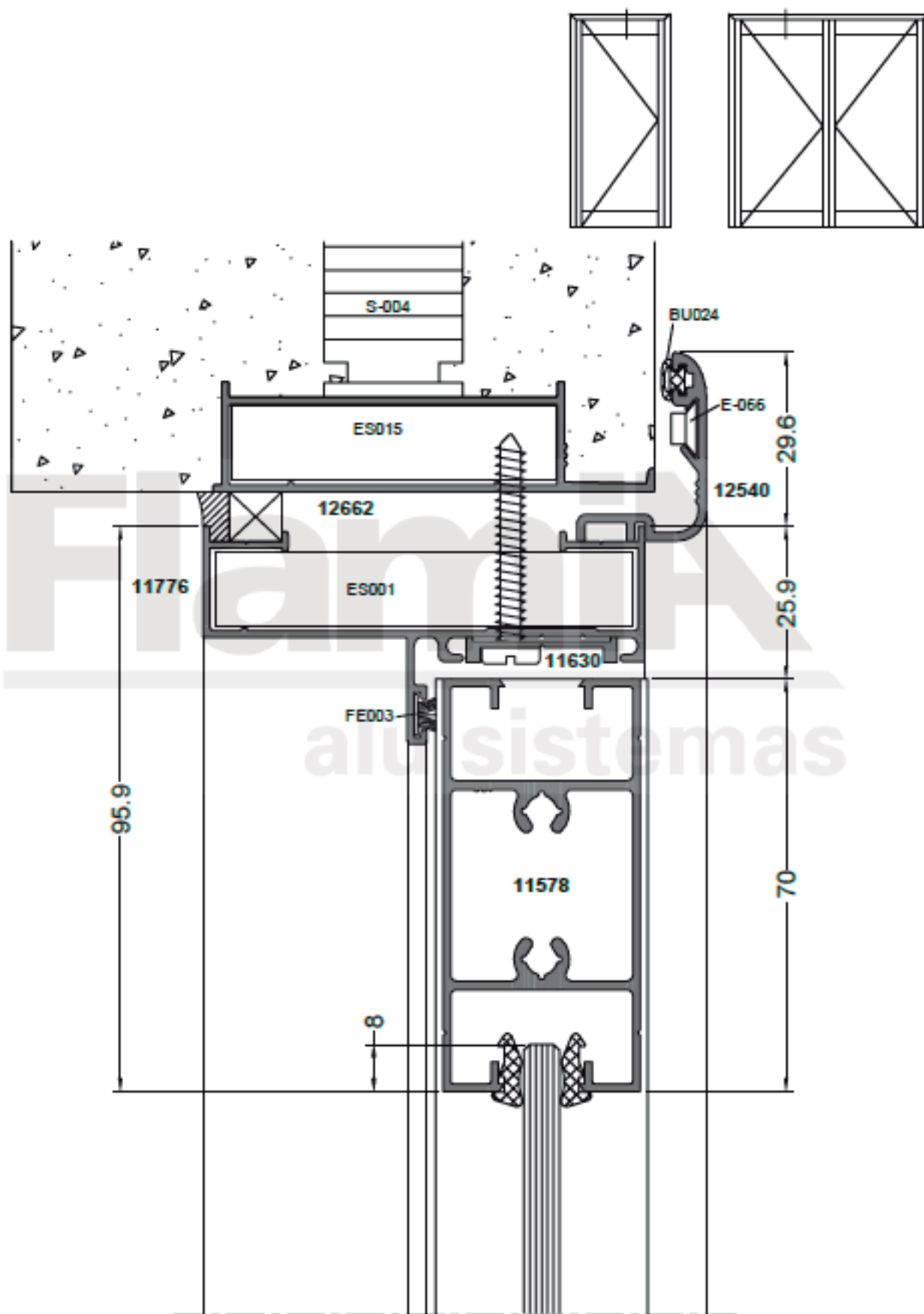

Corte vertical puerta de abrir 1 y 2 hojas.
Hoja 11577 y marco 11776.

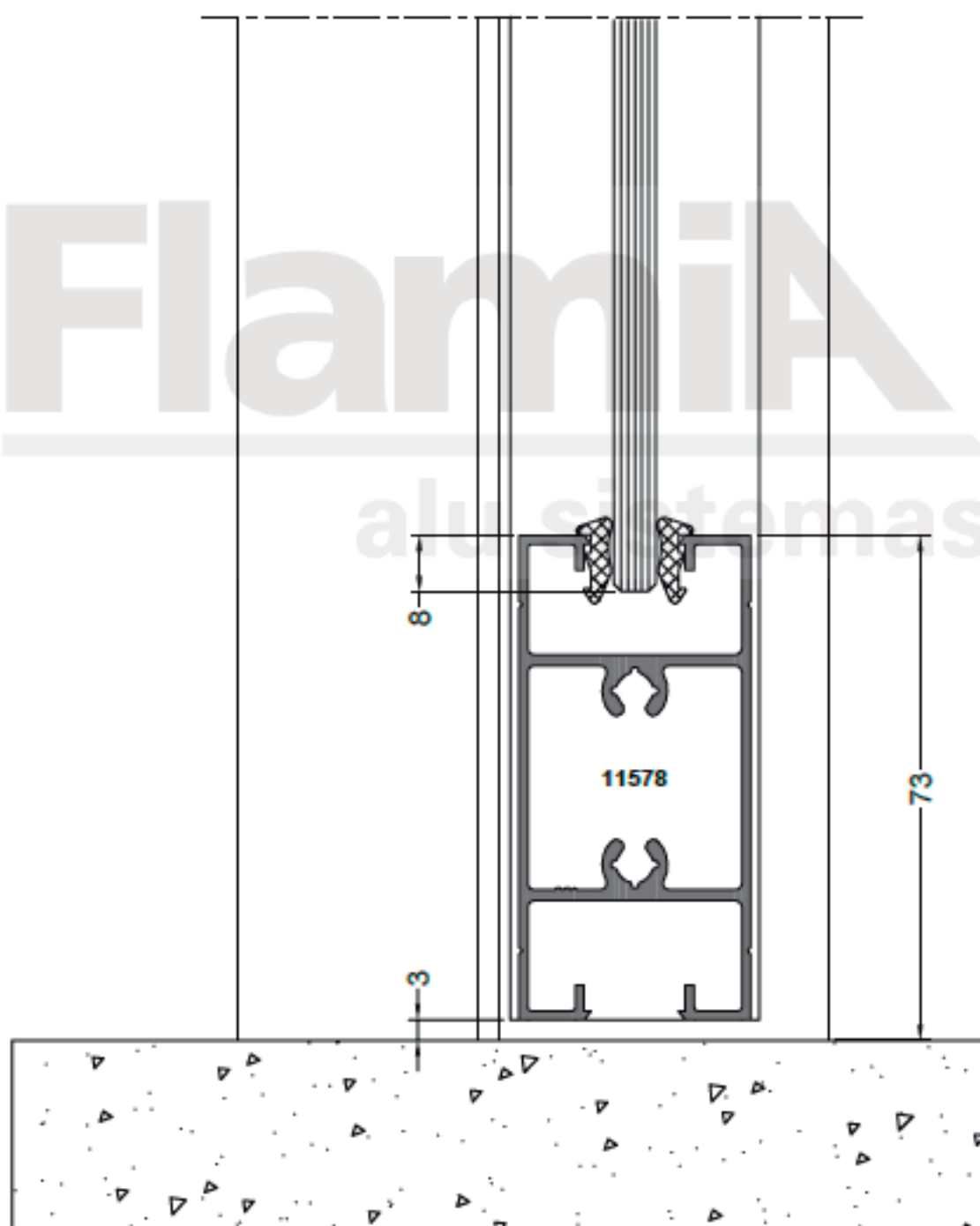
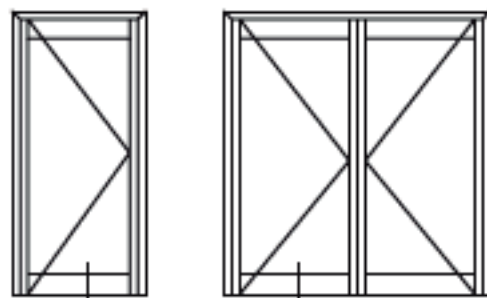

Corte vertical puerta de abrir 1 y 2 hojas.
 Hoja 11577 y marco 11776 con revestimiento 11781.

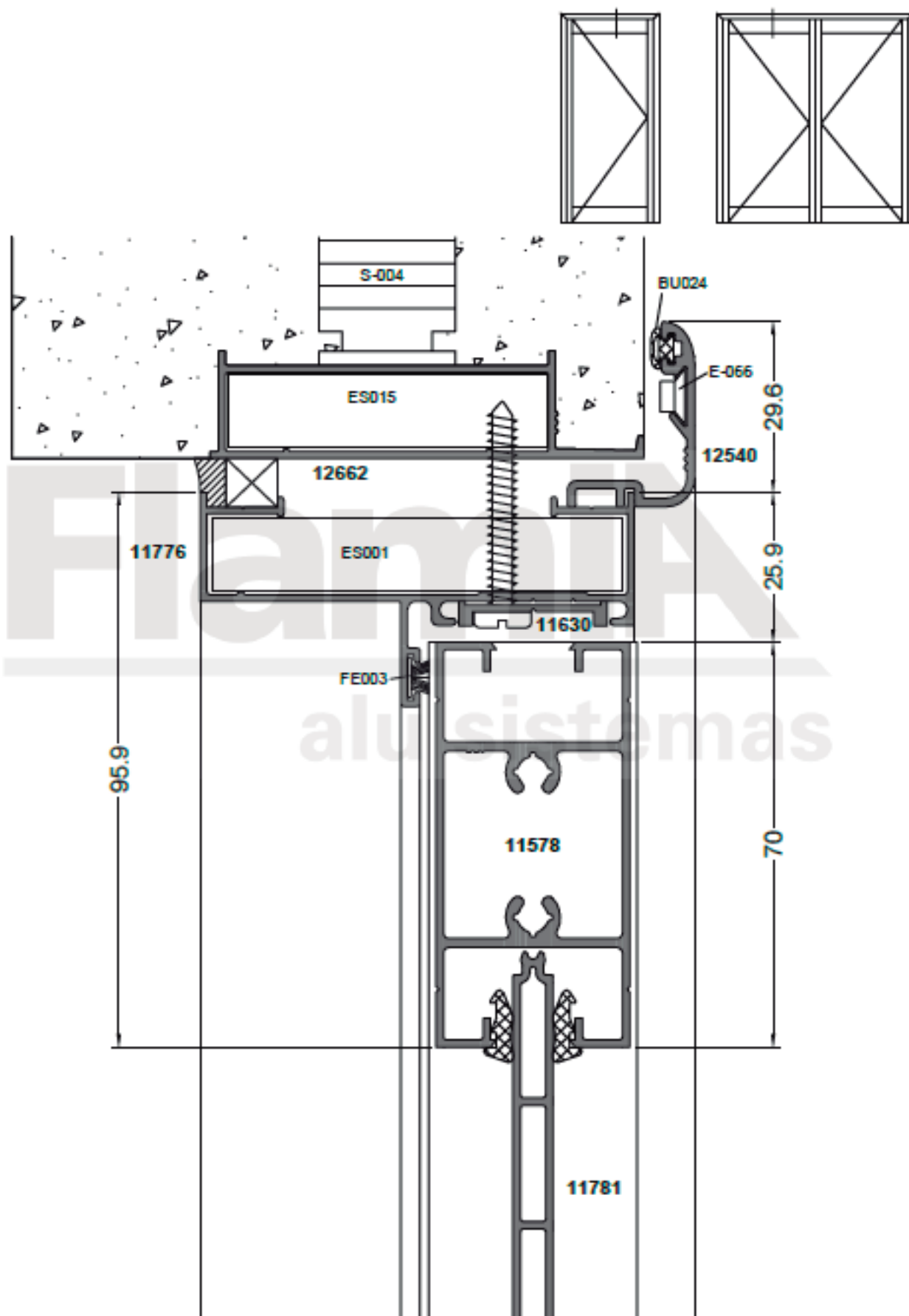

Corte vertical puerta de abrir 1 y 2 hojas.
Hoja 11577 y marco 11776 con revestimiento 11781.

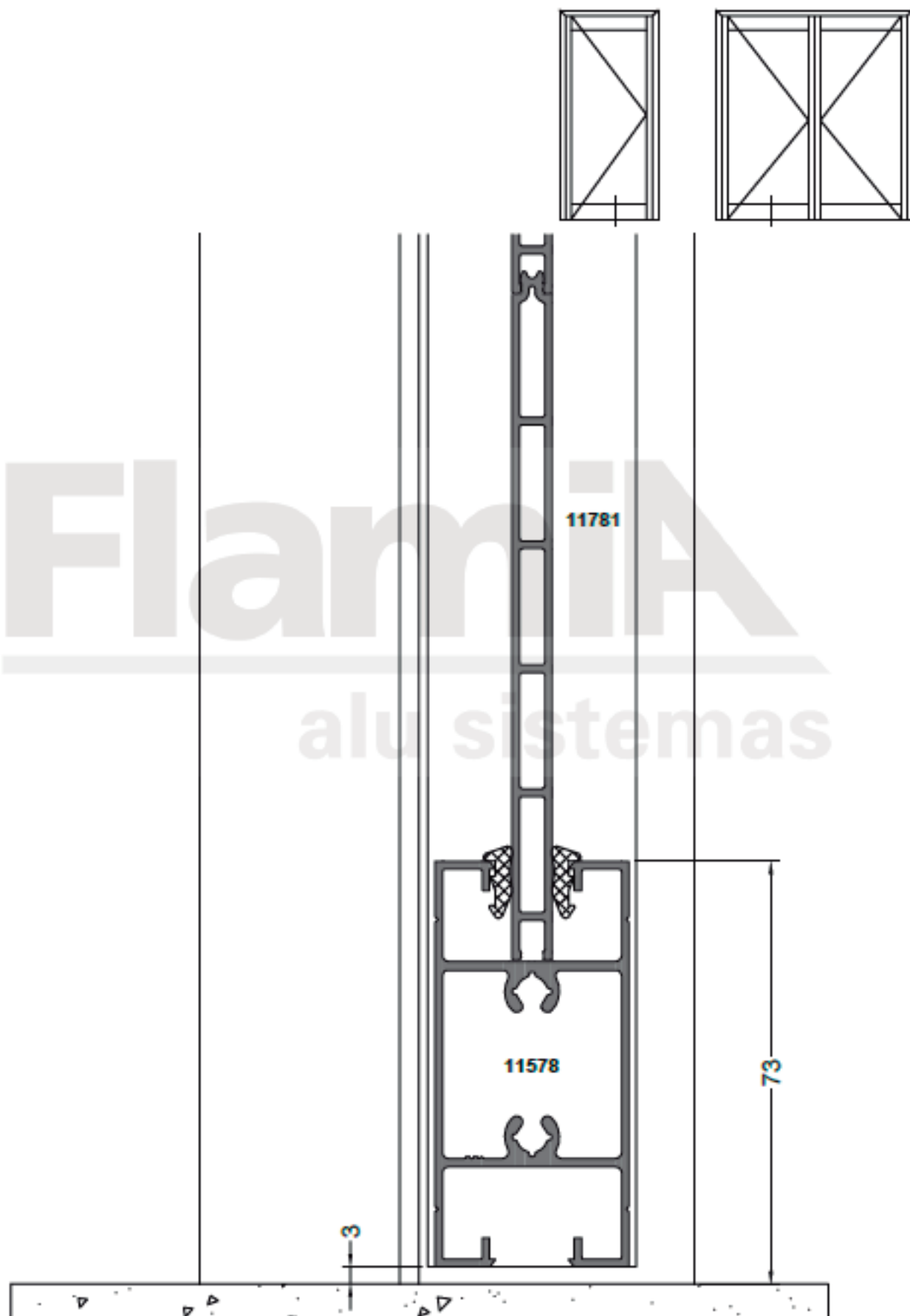

Corte horizontal puerta de abrir 1 y 2 hojas.
Hoja 11252.

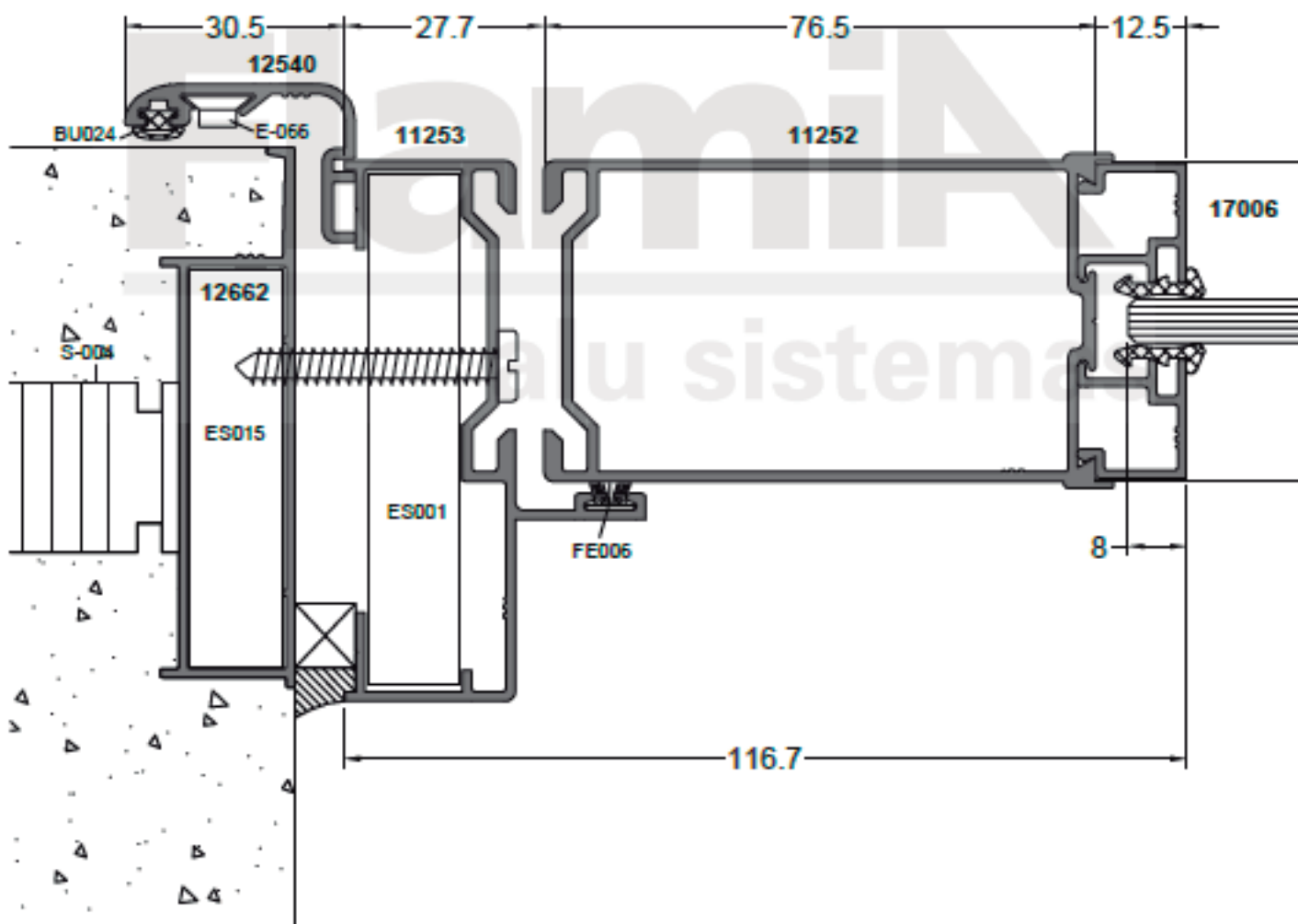
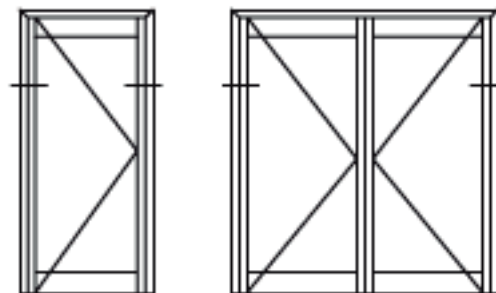

Corte horizontal puerta de abrir 1 y 2 hojas.
Hoja 11252.

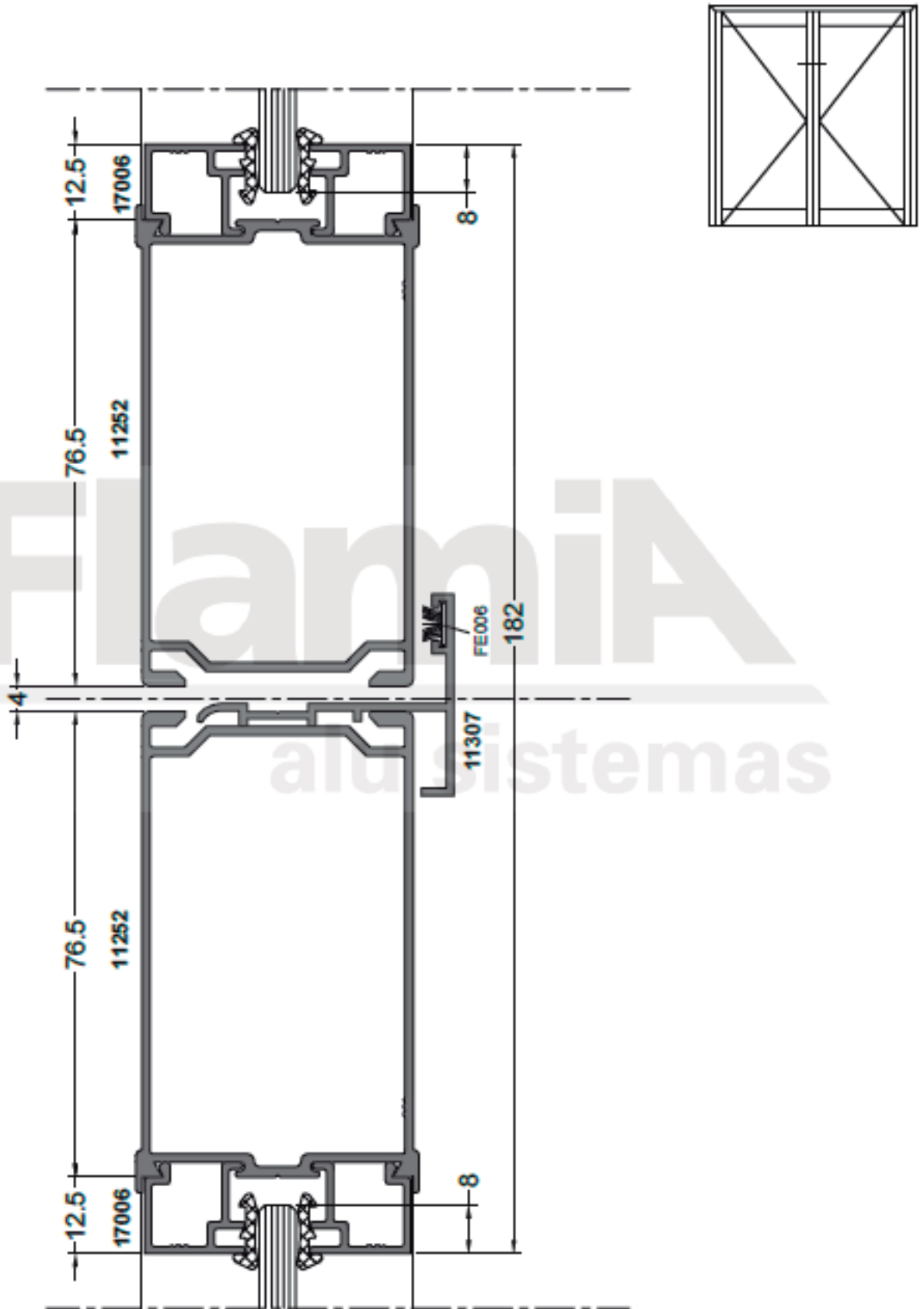

Corte vertical puerta de abrir 1 y 2 hojas.
Hoja 11252.

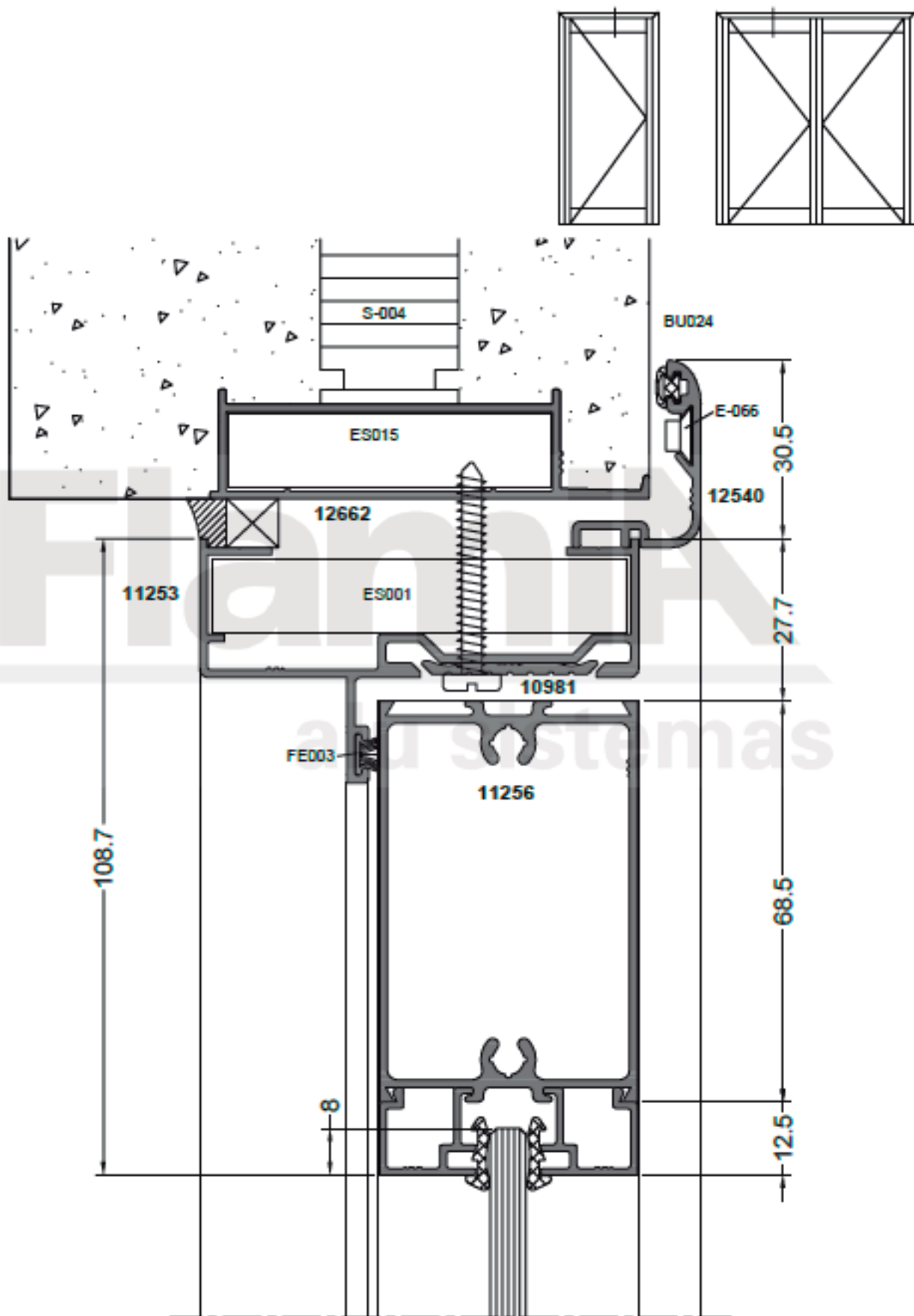

Corte vertical puerta de abrir 1 y 2 hojas.
Hoja 11252.

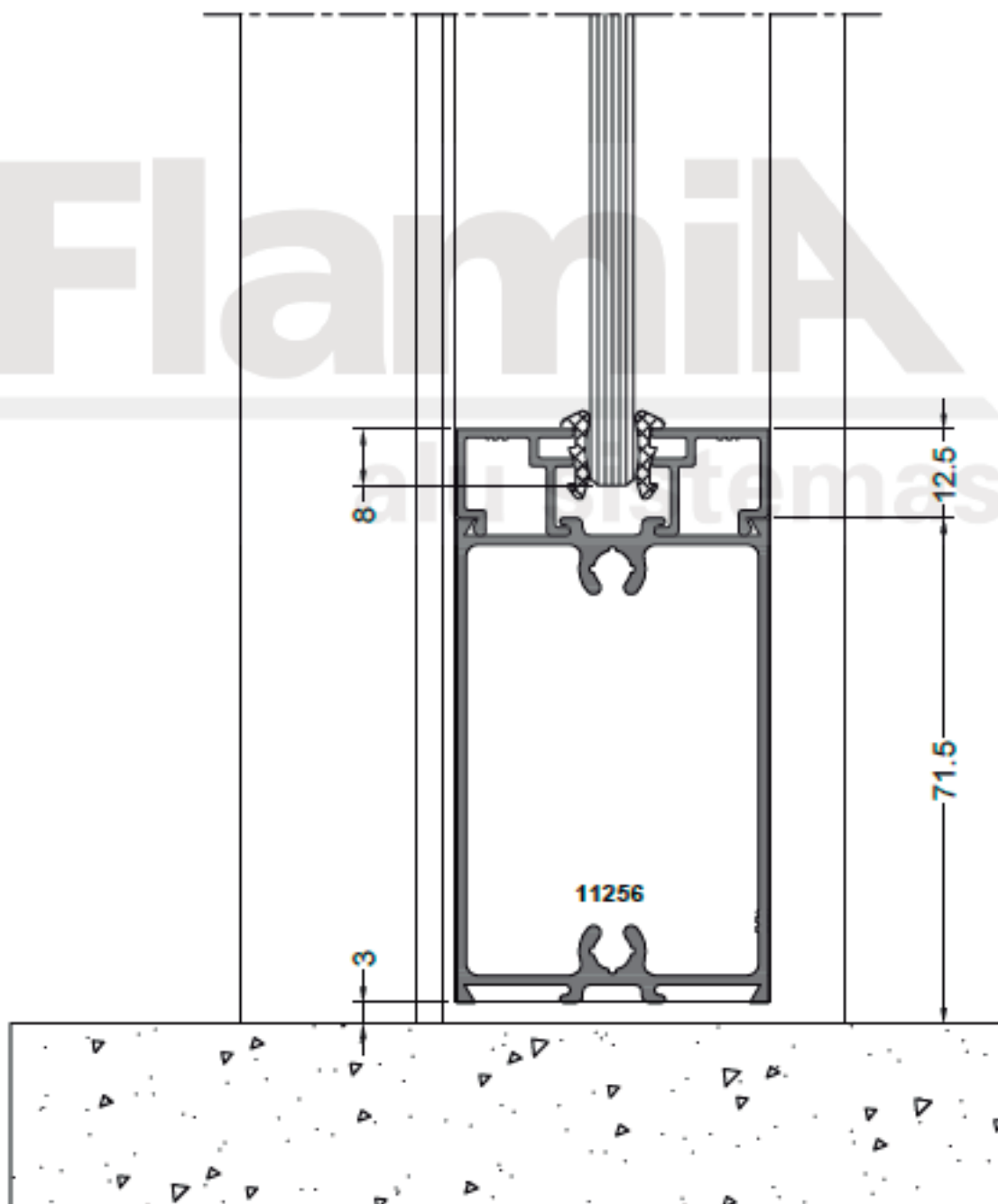
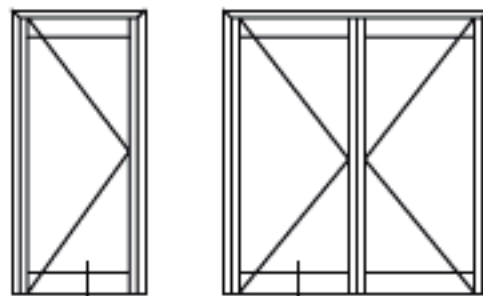

Corte vertical puerta de abrir 1 y 2 hojas.
 Hoja 11252 con revestimiento 11686.

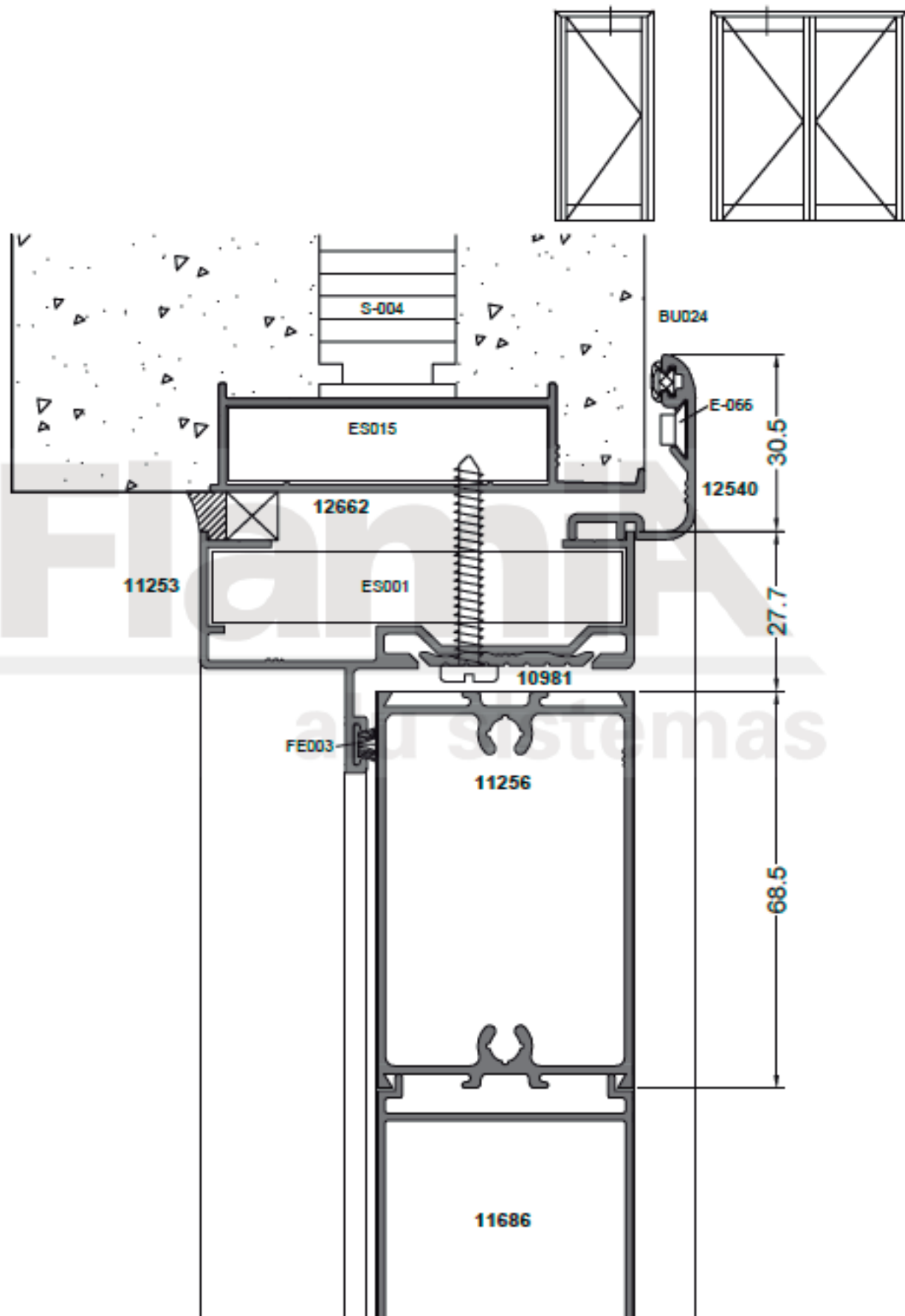

Corte vertical puerta de abrir 1 y 2 hojas.
Hoja 11252 con revestimiento 11686.

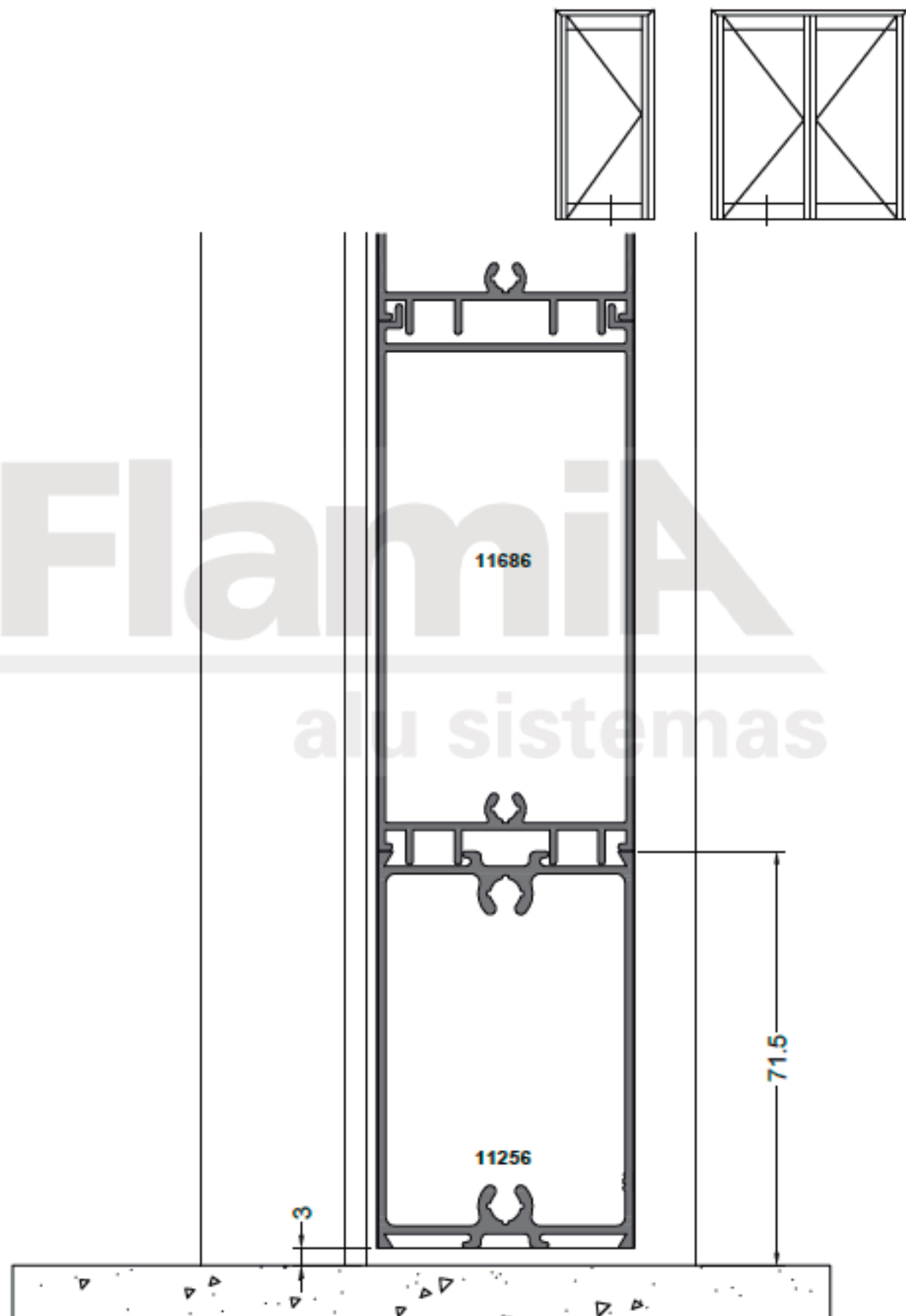

Corte horizontal puerta de abrir 1 y 2 hojas.
Hoja 14030 y marco 11776.

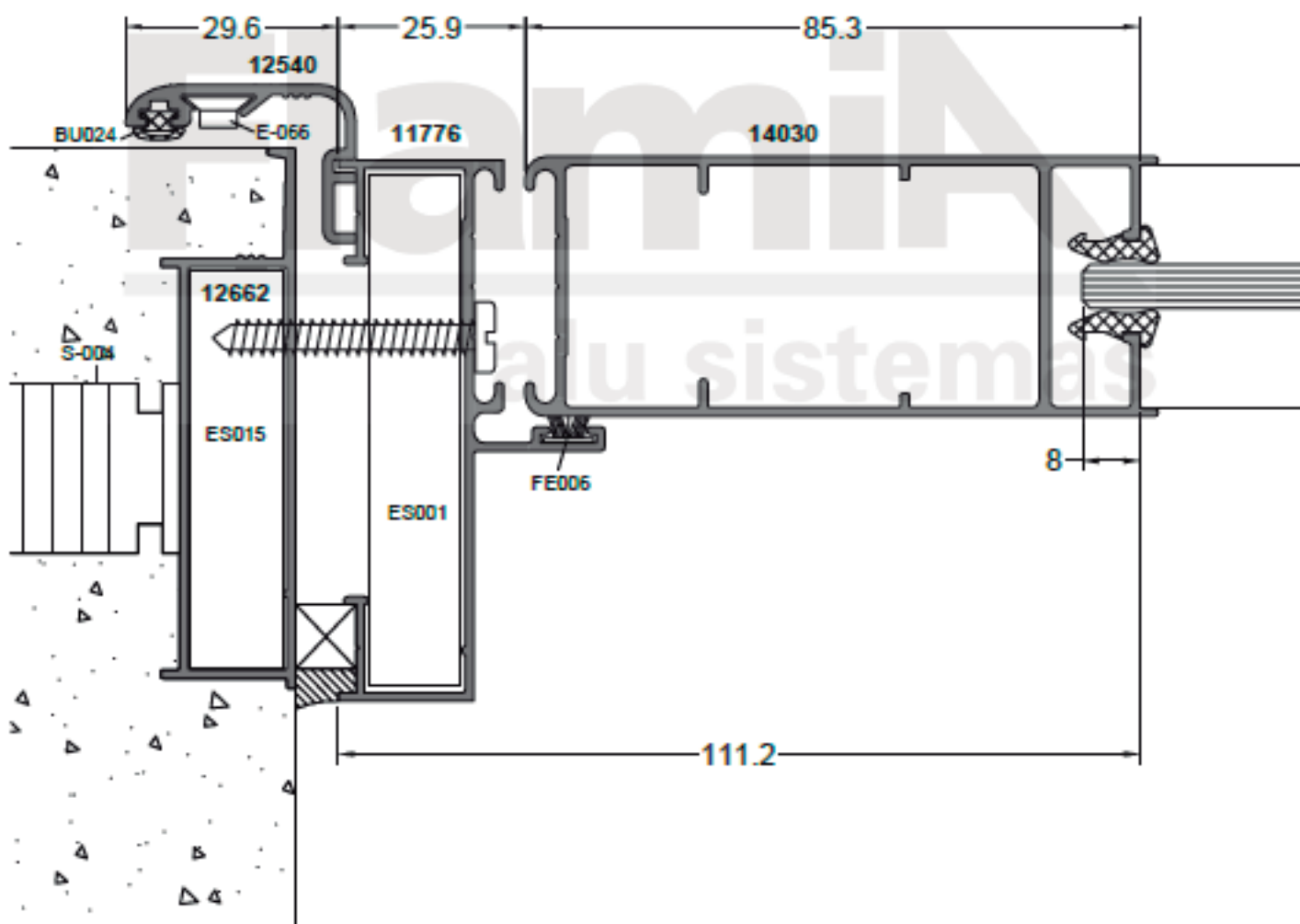
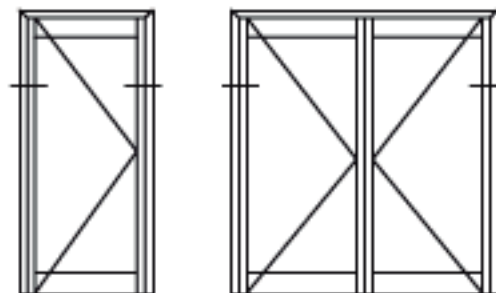

Corte horizontal puerta de abrir 1 y 2 hojas.
Hoja 14030 y marco 11776.

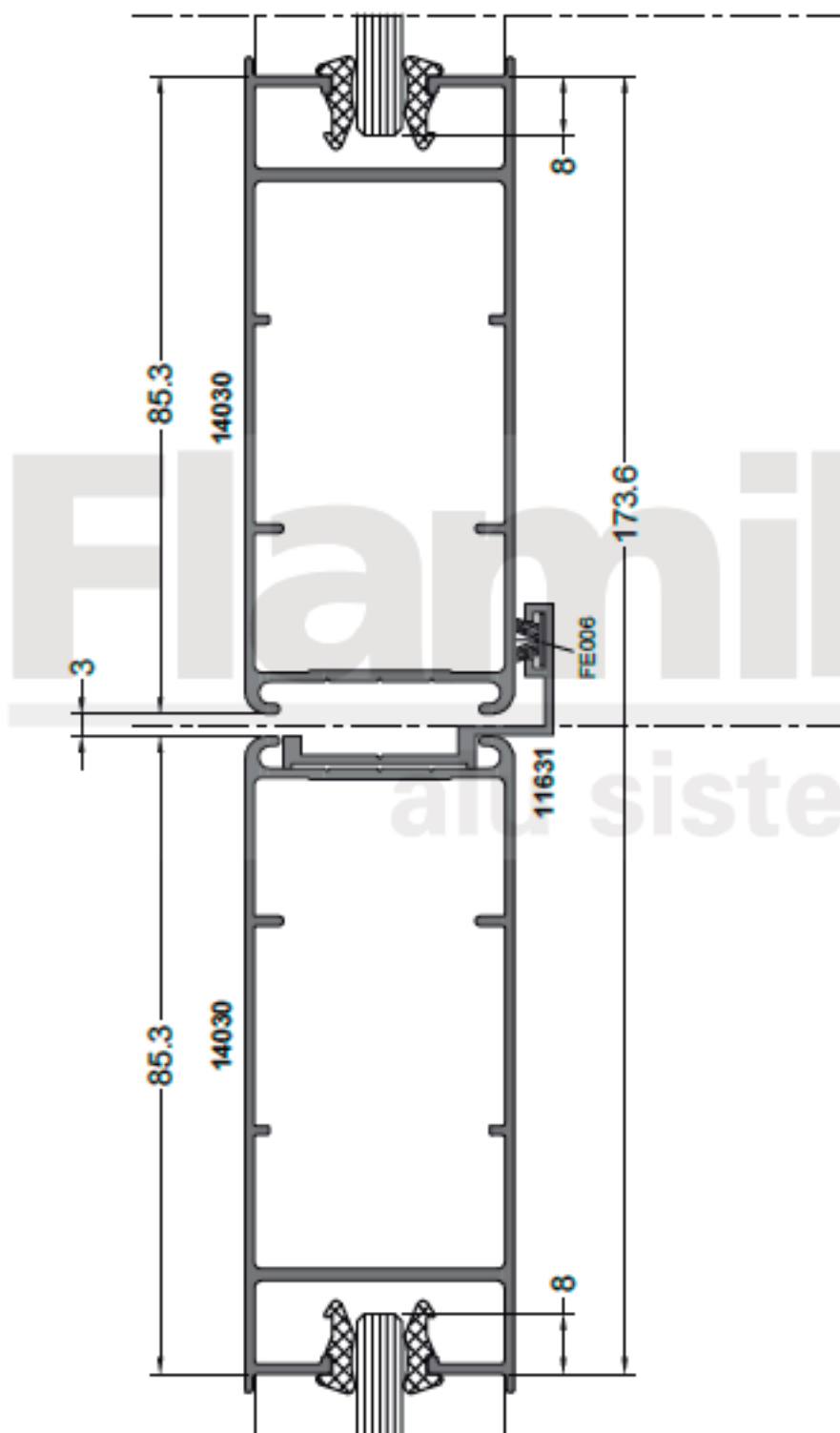
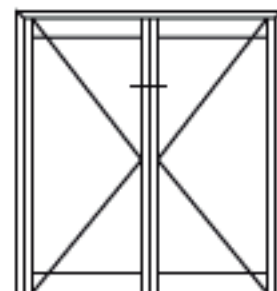

Corte vertical puerta de abrir 1 y 2 hojas.
Hoja 14030 y marco 11776.

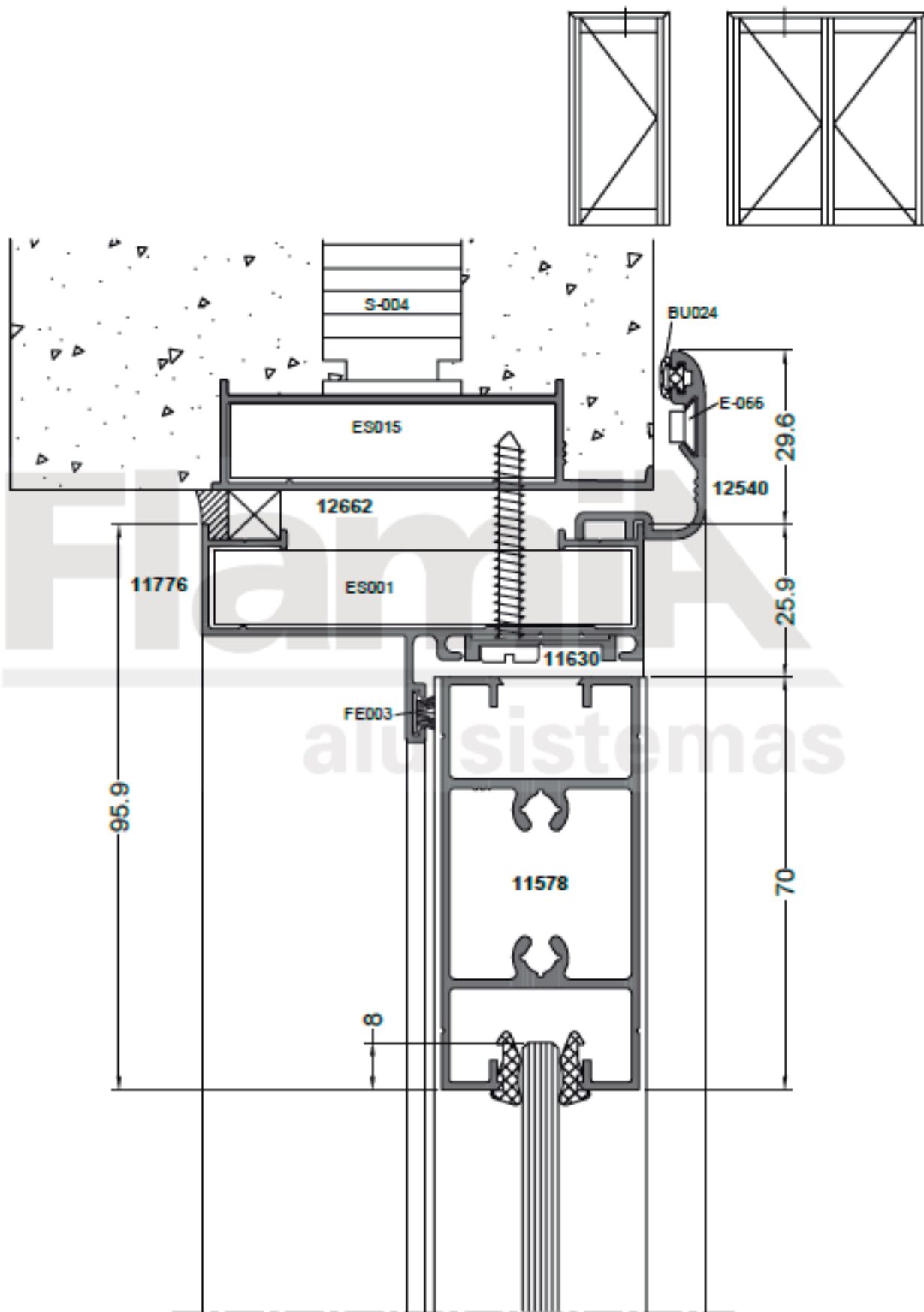

Corte vertical puerta de abrir 1 y 2 hojas.
Hoja 14030 y marco 11776.

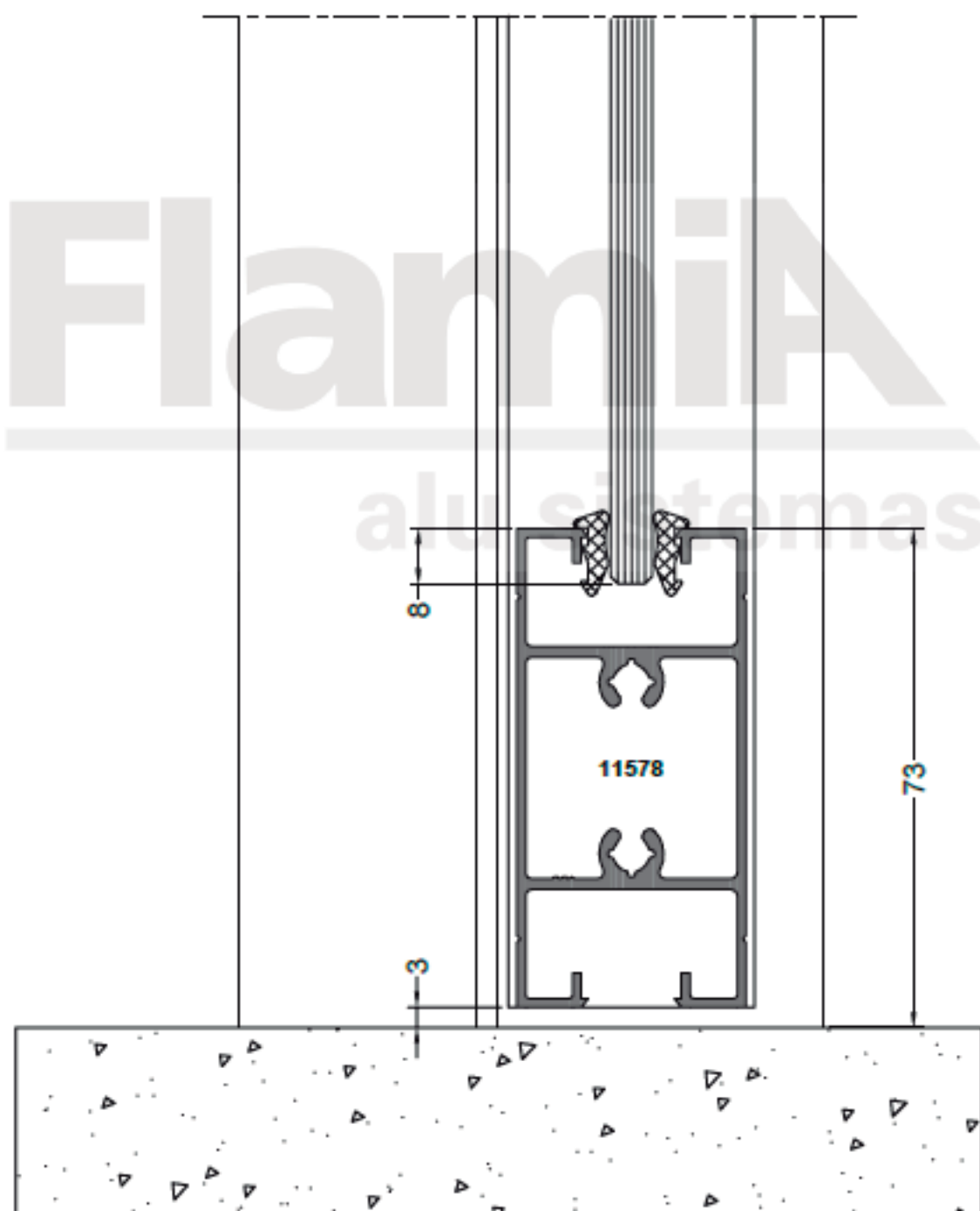
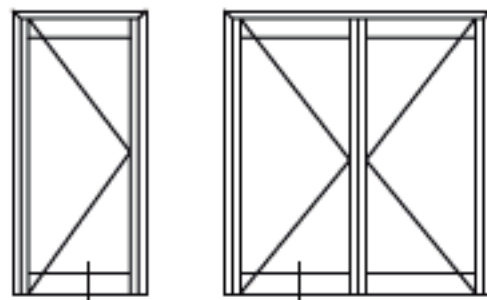





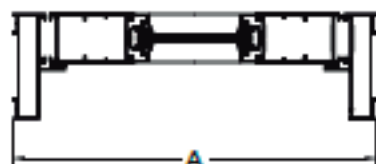







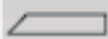





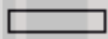

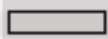

Listado de perfiles (Hoja 11577 y marco 11776)

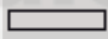
1 hoja



2 hojas



Código	Perfil	Descripción	Peso (kg/m)	Corte	1 Hoja				2 Hojas			
					Horizontal		Vertical		Horizontal		Vertical	
					Cant.	Medida	Cant.	Medida	Cant.	Medida	Cant.	Medida
11778		Marco	0.565		1	A			1	A		
11778		Marco	0.565				2	H			2	H
11577		Hoja	0.750				2	H - 29			4	H - 29
11578		Umbral y zócalo	1.080		2	A - 168			4	A/2-143		
11748		Contravidrio	0.157				4	H - 169			8	H - 169
11630		Tapacanto	0.110		1	A - 46	2	H - 23	1	A - 46	2	H - 23
11631		Tapa umbral	0.144								1	H - 29
11781		Revestimiento	0.894			A - 177				A/2-153		
12662		Premarco	0.563		1	A + 40			1	A + 40		
12662		Premarco	0.563				2	H + 20			2	H + 20
12540		Tapajunta	0.281		1	A + 59			1	A + 59		
12540		Tapajunta	0.281				2	H + 29			2	H + 29

FORMULA DE CORTE VALIDA UNICAMENTE PARA LA CONSTRUCCION DE UN PROTOTIPO.
NO APTA PARA PRODUCCION DE ABERTURAS

Listado de accesorios básicos (Hoja 11577)

Código	Descripción	Cantidad	
		1 hoja	2 hojas
S-004	Grampa de amure (se coloca a 250 mm. de los extremos y luego cada 500 mm.)		
ES015	Escuadra premarco		4
E-088	Escuadra de alineación tapajunta		4
BU024	Burlete tapajunta	Ancho	2
		Alto	2
ES001	Escuadra para marco		4
BI014 - BI015	Bisagra Natural / Blanco / Negro	3	6
PI004	Picaporte con bocallave regulable Blanco / Negro		1
PI006	Picaporte con recuperación automática Blanco / Negro		1
CE001	Cerradura (Kallay 3001)		1
PP001	Pasador a palanca con varilla corta (200 mm.)		1
PP002	Pasador a palanca con varilla larga (600 mm.)		1
PP003	Pasador GM doble		1
BU038	Burlete tapacanto (opción al perfil 11630)	Ancho	1
		Alto	2
FE006	Felpa 7x4.5 mm.	Ancho	1
		Alto	2
BU008 - BU009 - BU010	Burlete cuña chica - mediana - grande	Ancho	4
		Alto	4
			8

alu sistemas





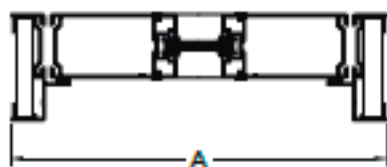



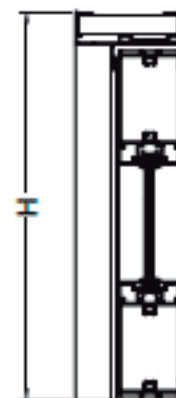
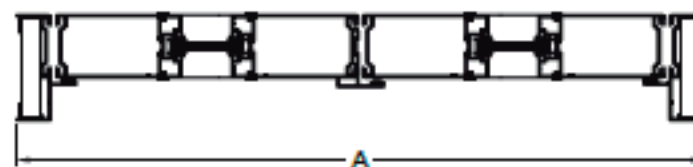















Listado de perfiles (Hoja 11252)

1 hoja



2 hojas



Código	Perfil	Descripción	Peso (kg/m)	Corte	1 Hoja				2 Hojas			
					Horizontal		Vertical		Horizontal		Vertical	
					Cant.	Medida	Cant.	Medida	Cant.	Medida	Cant.	Medida
11253		Marco	0.715		1	A			1	A		
11253		Marco	0.715				2	H			2	H
11252		Hoja	1.015				2	H - 29			4	H - 30
11256		Umbral y zócalo	1.040		2	A - 209			4	A/2-183		
11748		Contravidrio	0.157		4	A - 209	4	H - 192	8	A/2-183	8	H - 192
10981		Tapacanto	0.144		1	A - 48	2	H - 24	1	A - 48	2	H - 23
11307		Tapa umbral	0.287								1	H - 30
11686		Revestimiento	1.030			A - 209				A/2-183		
12662		Premarco	0.563		1	A + 40			1	A + 40		
12662		Premarco	0.563				2	H + 20			2	H + 20
12540		Tapajunta	0.281		1	A + 61			1	A + 61		
12540		Tapajunta	0.281				2	H + 31			2	H + 31

FORMULA DE CORTE VALIDA UNICAMENTE PARA LA CONSTRUCCION DE UN PROTOTIPO.
NO APTA PARA PRODUCCION DE ABERTURAS

Listado de accesorios básicos (Hoja 11252)

Código	Descripción	Cantidad	
		1 hoja	2 hojas
S-004	Grampa de amure (se coloca a 250 mm. de los extremos y luego cada 500 mm.)		
ES015	Escuadra premarco	4	
E-088	Escuadra de alineación tapajunta	4	
BU024	Burlete tapajunta	Ancho	2
		Alto	2
ES001	Escuadra para marco	4	
BI010 - BI011	Bisagra Natural / Blanco / Negro	3	6
H-50A	Picaporte con recuperación automática Blanco / Negro	1	
PI006	Picaporte con recuperación automática Blanco / Negro	1	
CE002	Cerradura (Kallay 4006)	1	
CE003	Cerradura doble perno (Kallay 4002)	1	
PP001	Pasador a palanca con varilla corta (200 mm.)		1
PP002	Pasador a palanca con varilla larga (600 mm.)		1
PP003	Pasador GM doble		1
BU038	Burlete tapacanto (opción al perfil 10981)	Ancho	1
		Alto	2
FE006	Felpa 7x4.5 mm.	Ancho	1
		Alto	2
BU008 - BU009 - BU010	Burlete cuña chica - mediana - grande	Ancho	4
		Alto	4
			8





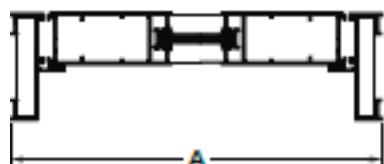















Listado de perfiles (Hoja 14030 y marco 11776)

1 hoja



2 hojas



Código	Perfil	Descripción	Peso (kg/m)	Corte	1 Hoja				2 Hojas			
					Horizontal		Vertical		Horizontal		Vertical	
					Cant.	Medida	Cant.	Medida	Cant.	Medida	Cant.	Medida
11776		Marco	0.565		1	A			1	A		
11776		Marco	0.565				2	H			2	H
14030		Hoja	0.972				2	H - 29			4	H - 29
11578		Umbral y zócalo	1.080		2	A - 222			4	A/2-198		
11630		Tapacanto	0.110		1	A - 46	2	H - 23	1	A - 46	2	H - 23
11631		Tapa umbral	0.144								1	H - 29
12662		Premarco	0.563		1	A + 40			1	A + 40		
12662		Premarco	0.563				2	H + 20			2	H + 20
12540		Tapajunta	0.281		1	A + 59			1	A + 59		
12540		Tapajunta	0.281				2	H + 29			2	H + 29

FORMULA DE CORTE VALIDA UNICAMENTE PARA LA CONSTRUCCION DE UN PROTOTIPO.
NO APTA PARA PRODUCCION DE ABERTURAS

Listado de accesorios básicos (Hoja 14030)

Código	Descripción	Cantidad	
		1 hoja	2 hojas
S-004	Grampa de amure (se coloca a 250 mm. de los extremos y luego cada 500 mm.)		
ES015	Escuadra premarco	4	
E-088	Escuadra de alineación tapajunta	4	
BU024	Burlete tapajunta	Ancho	2
		Alto	2
ES001	Escuadra para marco	4	
BI014 - BI015	Bisagra Natural / Blanco / Negro	3	6
PI004	Picaporte con bocallave regulable Blanco / Negro	1	
PI006	Picaporte con recuperación automática Blanco / Negro	1	
CE001	Cerradura (Kallay 3001)	1	
CE002	Cerradura (Kallay 4006)	1	
CE003	Cerradura doble perno (Kallay 4002)	1	
PP001	Pasador a palanca con varilla corta (200 mm.)		1
PP002	Pasador a palanca con varilla larga (600 mm.)		1
PP003	Pasador GM doble		1
BU038	Burlete tapacanto (opción al perfil 11630)	Ancho	1
		Alto	2
FE006	Felpa 7x4.5 mm.	Ancho	1
		Alto	2
BU008 - BU009 - BU010	Burlete cuña chica - mediana - grande	Ancho	4
		Alto	4

SISTEMAS DE CARPINTERIA

Standard

VENTANA VENTILUZ



Corte horizontal ventana ventiluz.

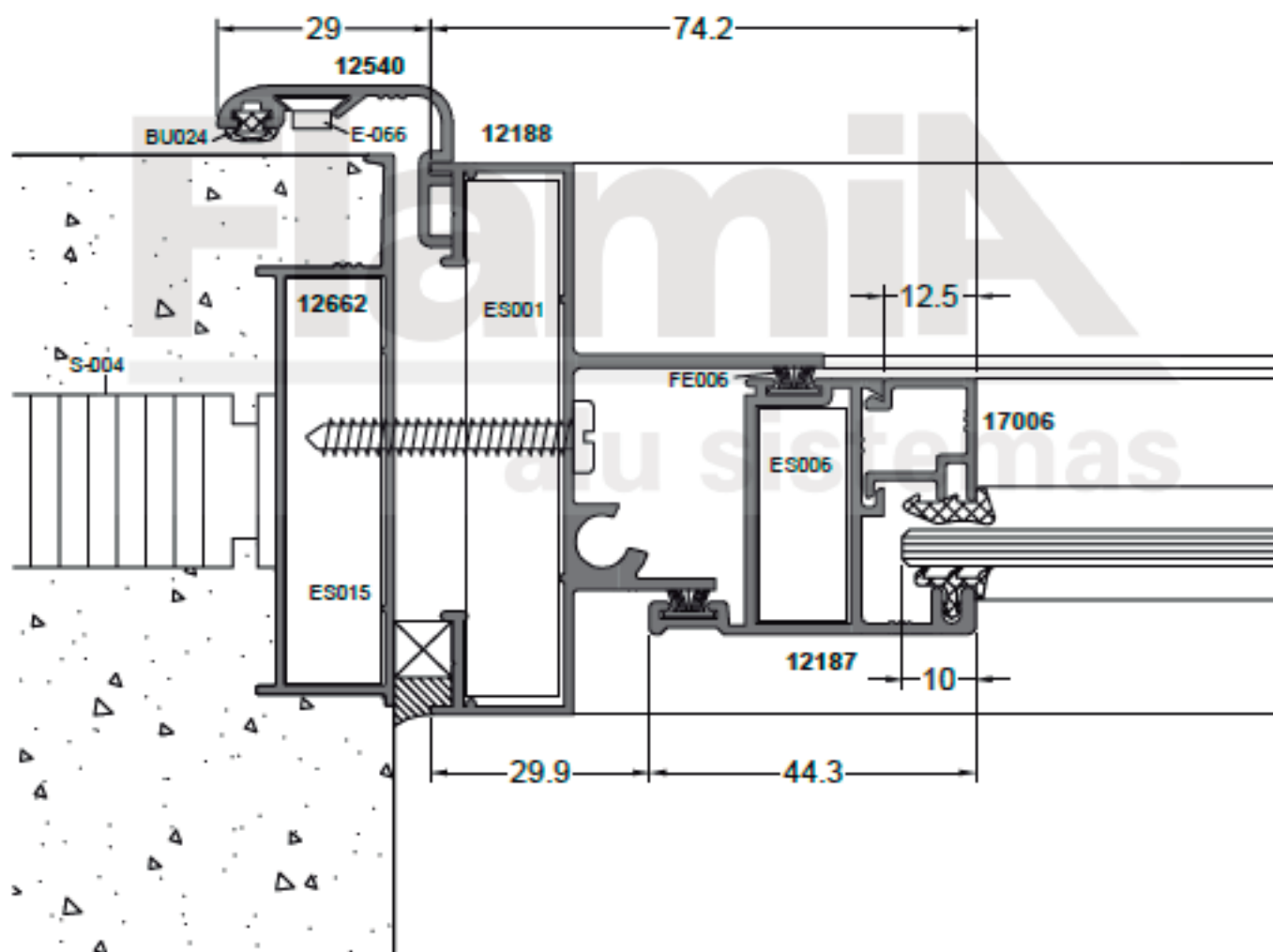
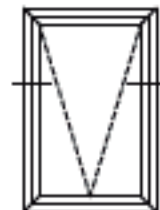

Corte vertical ventana ventiluz.

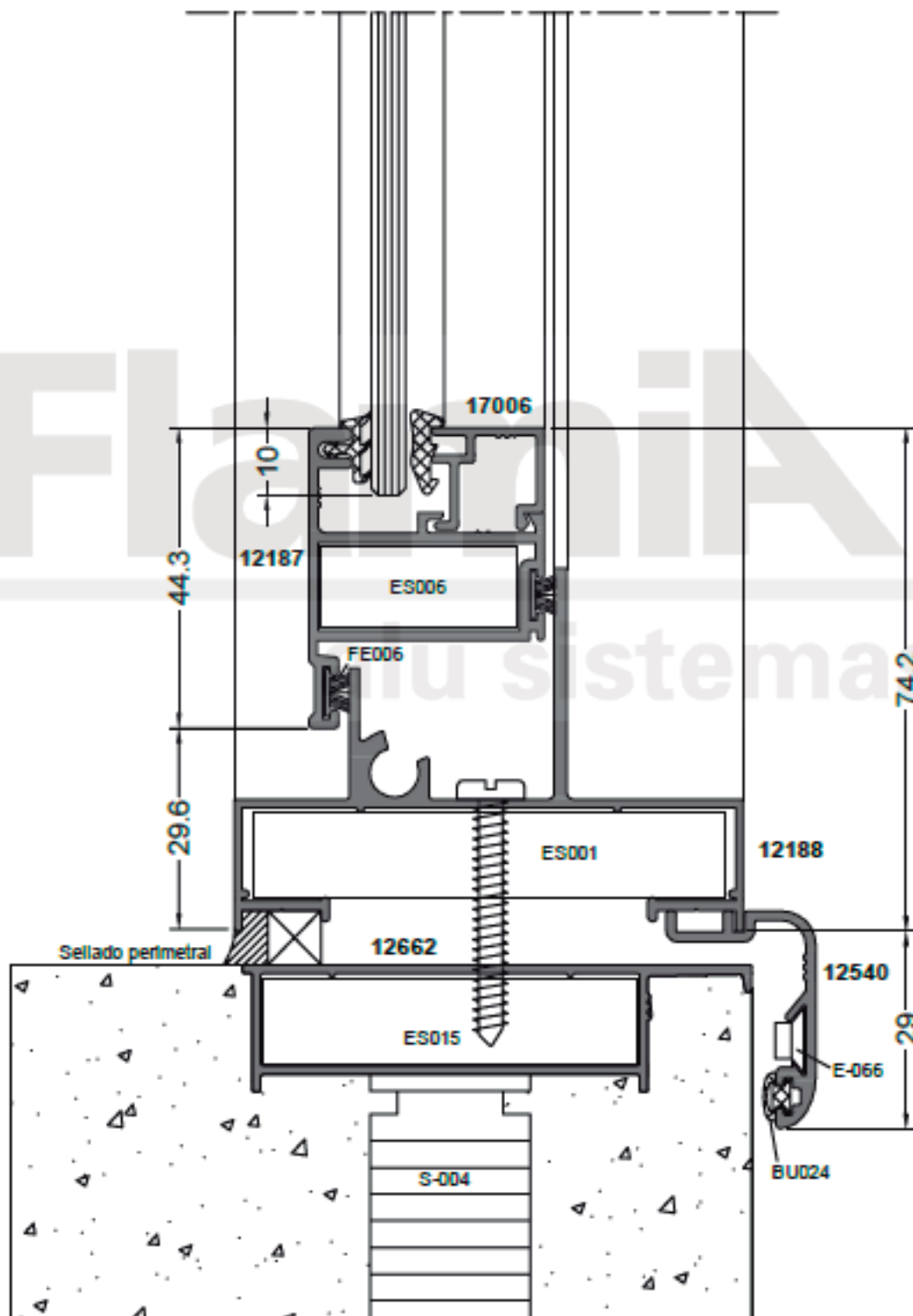
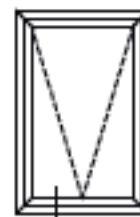



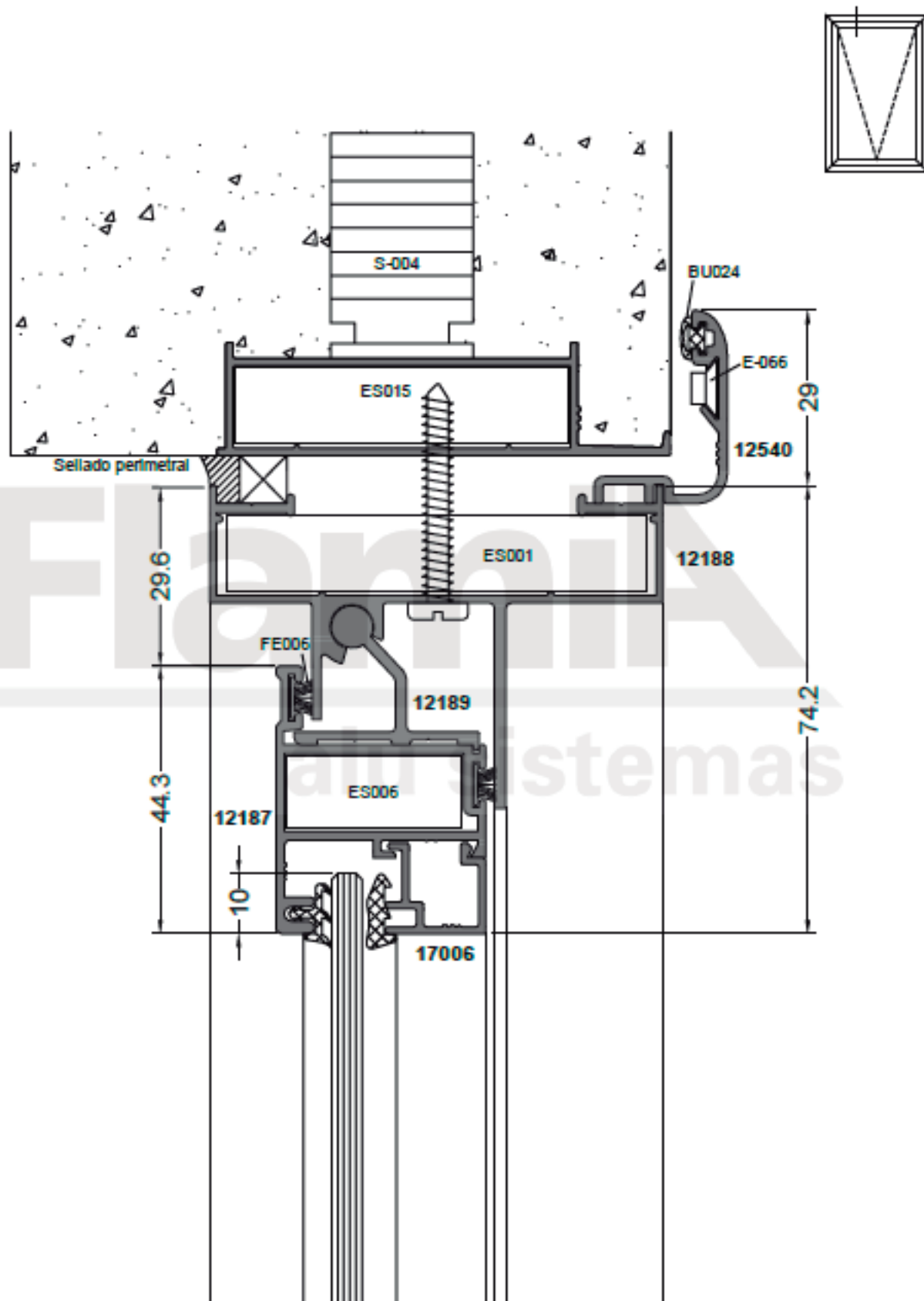



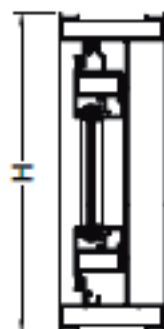
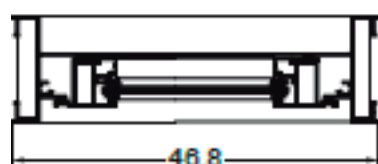



Corte vertical ventana ventiluz.

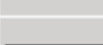

Listado de perfiles

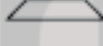

Código	Perfil	Descripción	Peso (kg/m)	Corte	1 Hoja			
					Horizontal		Vertical	
					Cant.	Medida	Cant.	Medida
12188		Marco	0.828		2	A	2	H
12187		Hoja	0.589		2	A - 60	2	H - 60
12189		Bisagra	0.315		1	A - 60		
17006		Contravidrio	0.170		2	A - 124	2	H - 148
12662		Premarco	0.563		2	A + 40	2	H + 40
12540		Tapajunta	0.281		2	A + 58	2	H + 58

Listado de accesorios

Código	Descripción	Cantidad	
S-004	Grampa de amure (se coloca a 250 mm. de los extremos y luego cada 500 mm.)		
ES015	Escuadra premarco	4	
E-068	Escuadra de alineación tapajunta	4	
BU024	Burlete tapajunta	Ancho	2
		Alto	2
ES001	Escuadra para marco	4	
ES006	Escuadra para hoja	4	
BR003	Brazo de empuje	1	
FE006	Felpa 7x4.5 mm.	Ancho	4
		Alto	4
BU007	Burlete exterior vidrio	Ancho	2
		Alto	2
BU008 - BU009 - BU010	Burlete cuña chica - mediana - grande	Ancho	4
		Alto	4

**FORMULA DE CORTE VALIDA UNICAMENTE PARA LA CONSTRUCCION DE UN PROTOTIPO.
NO APTA PARA PRODUCCION DE ABERTURAS**

SISTEMAS DE CARPINTERIA

Standard

VENTANA POSTIGON



Corte horizontal postigón de abrir
Hoja 12204.

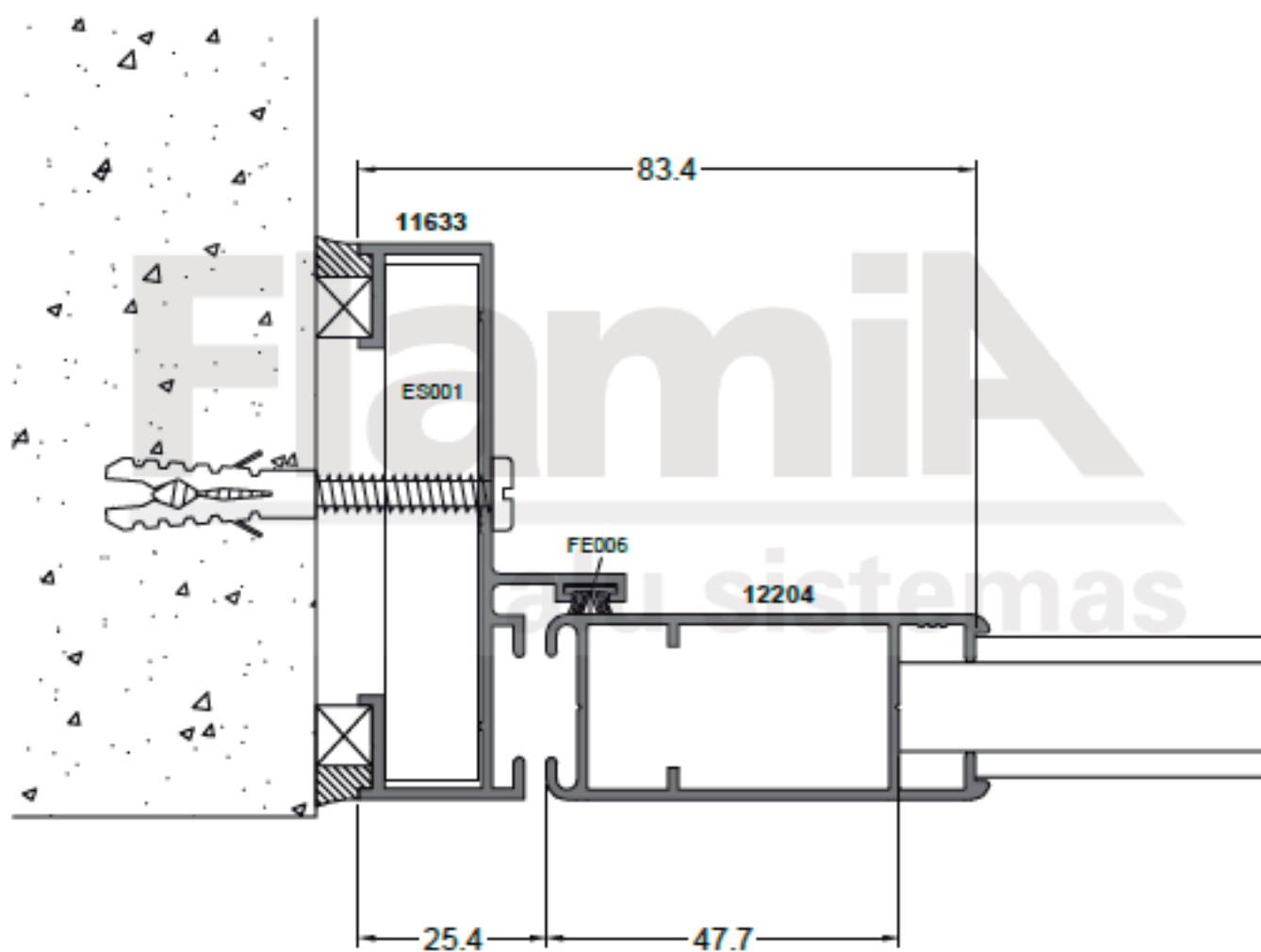

Corte horizontal postigón de abrir 2 hojas
Hoja 12204.

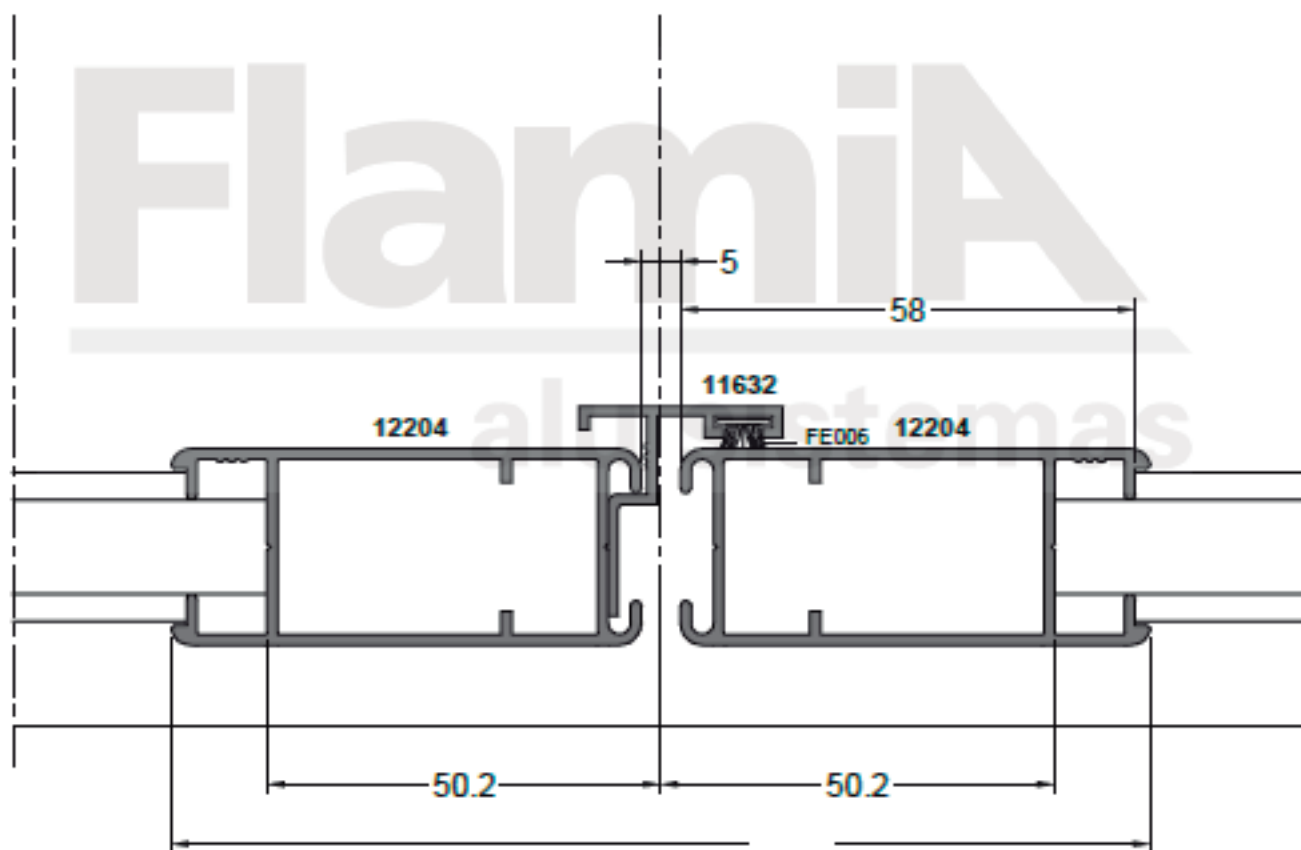
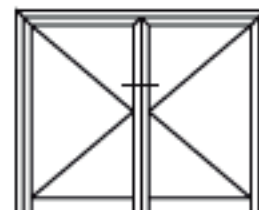

Corte vertical postigón de abrir
Hoja 12204 con zócalo 10812.

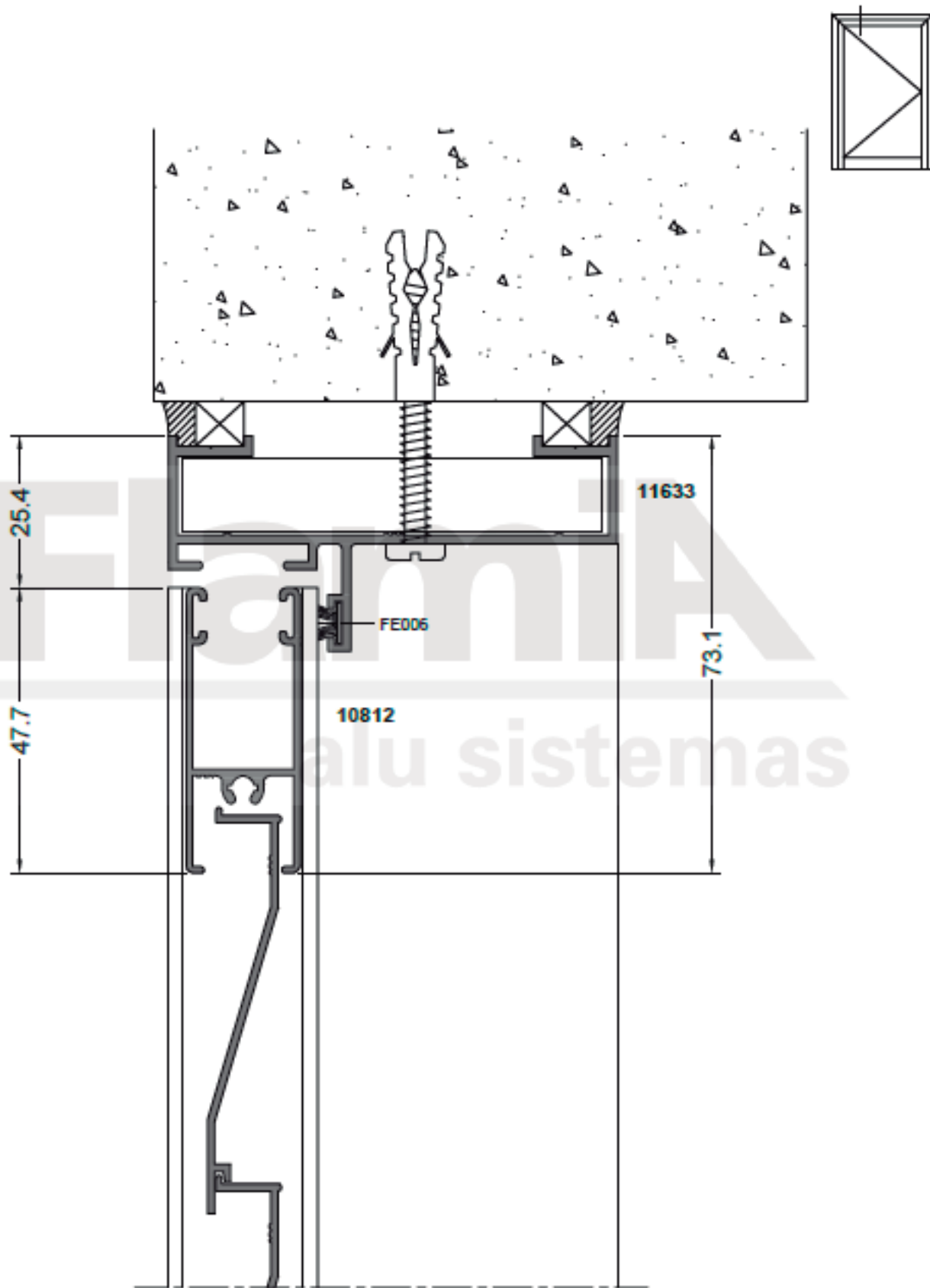

Corte vertical postigón de abrir
Hoja 12204 y marco armado a 45°.

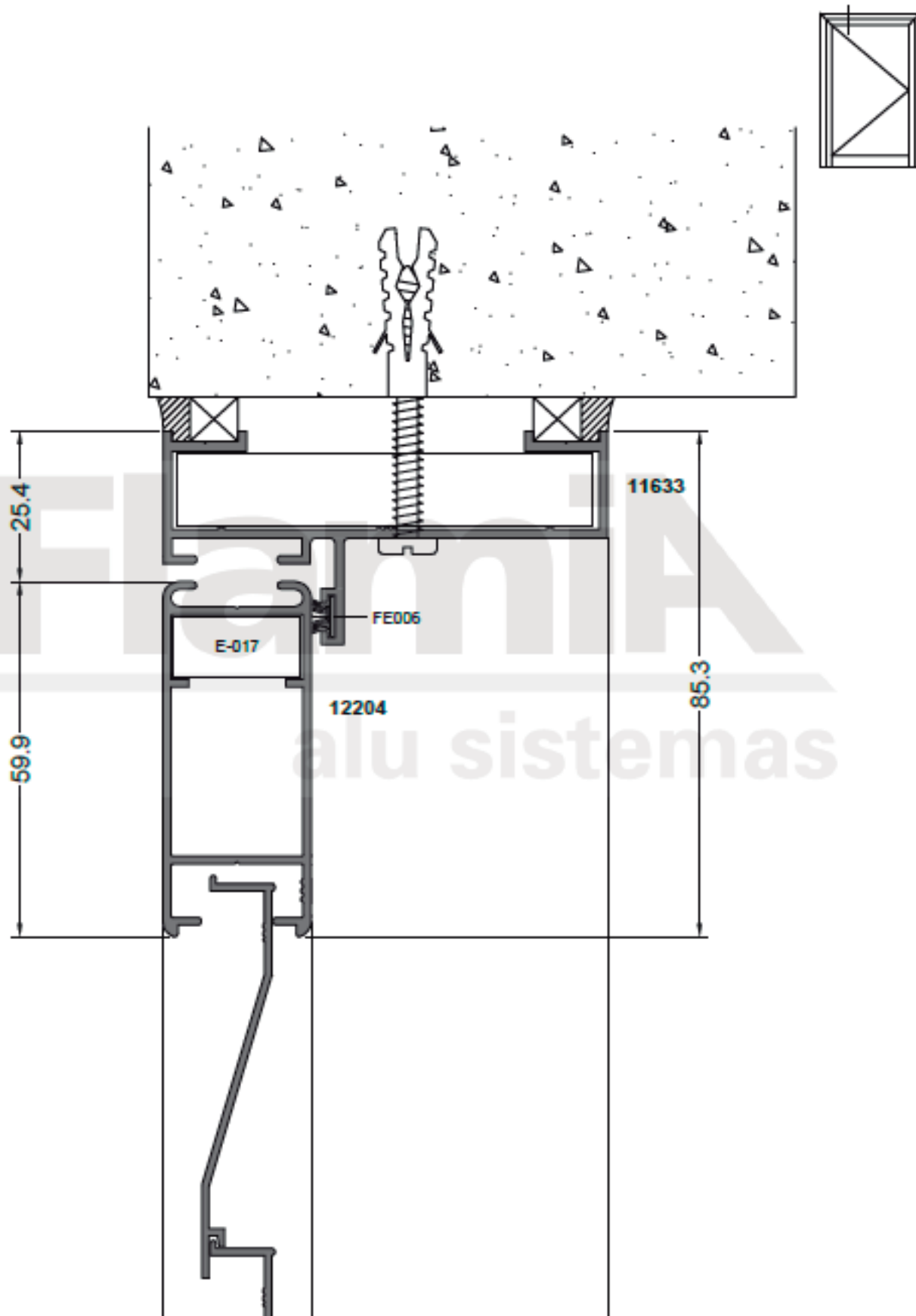

Corte vertical postigón de abrir
Hoja 12204 con zócalo 99044.

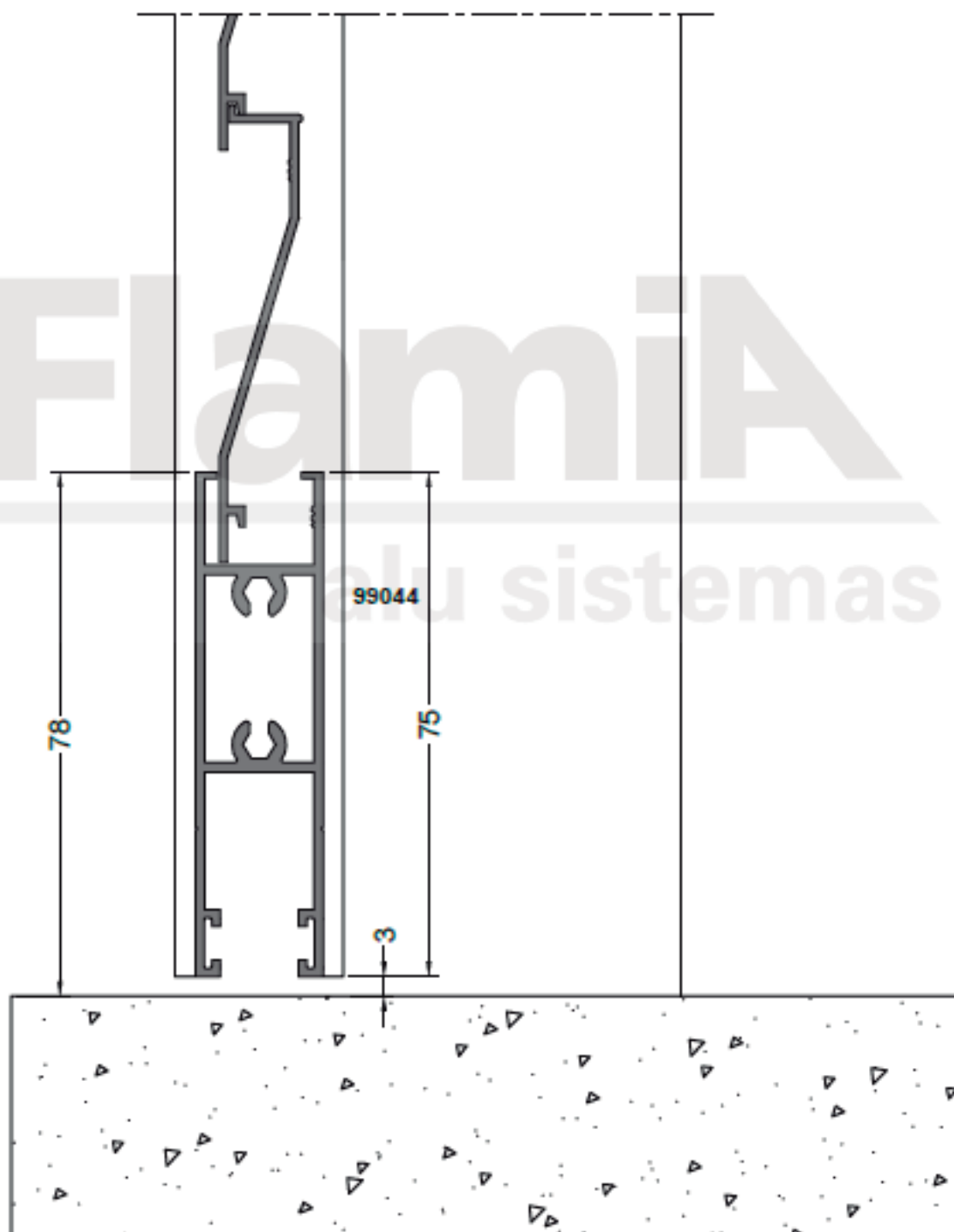

Corte vertical postigón de abrir
Hoja 12204 con zócalo 10812.

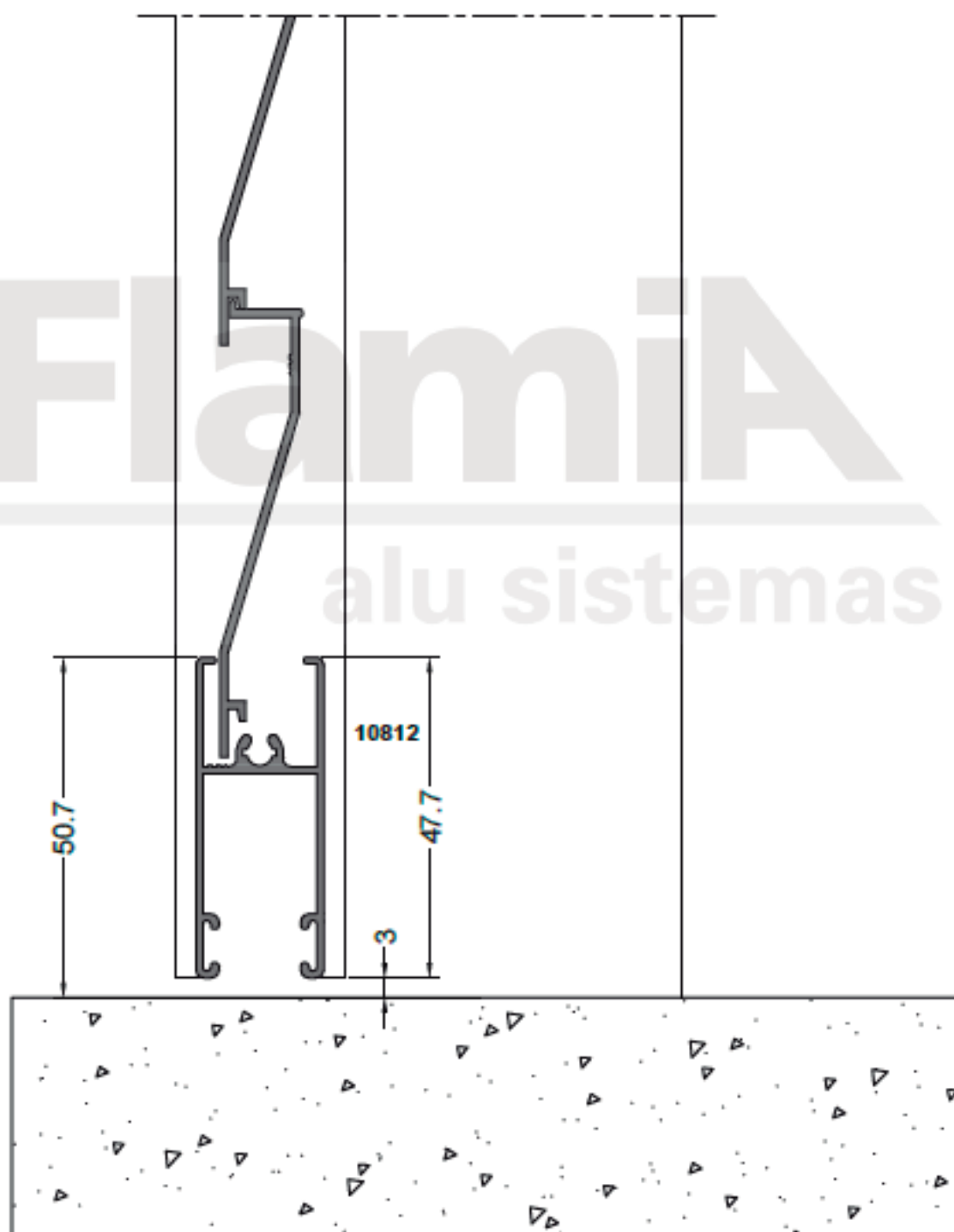
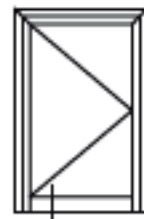

Corte vertical postigón de abrir
Hoja 12204 con zócalo 10812 con marco a 45°.

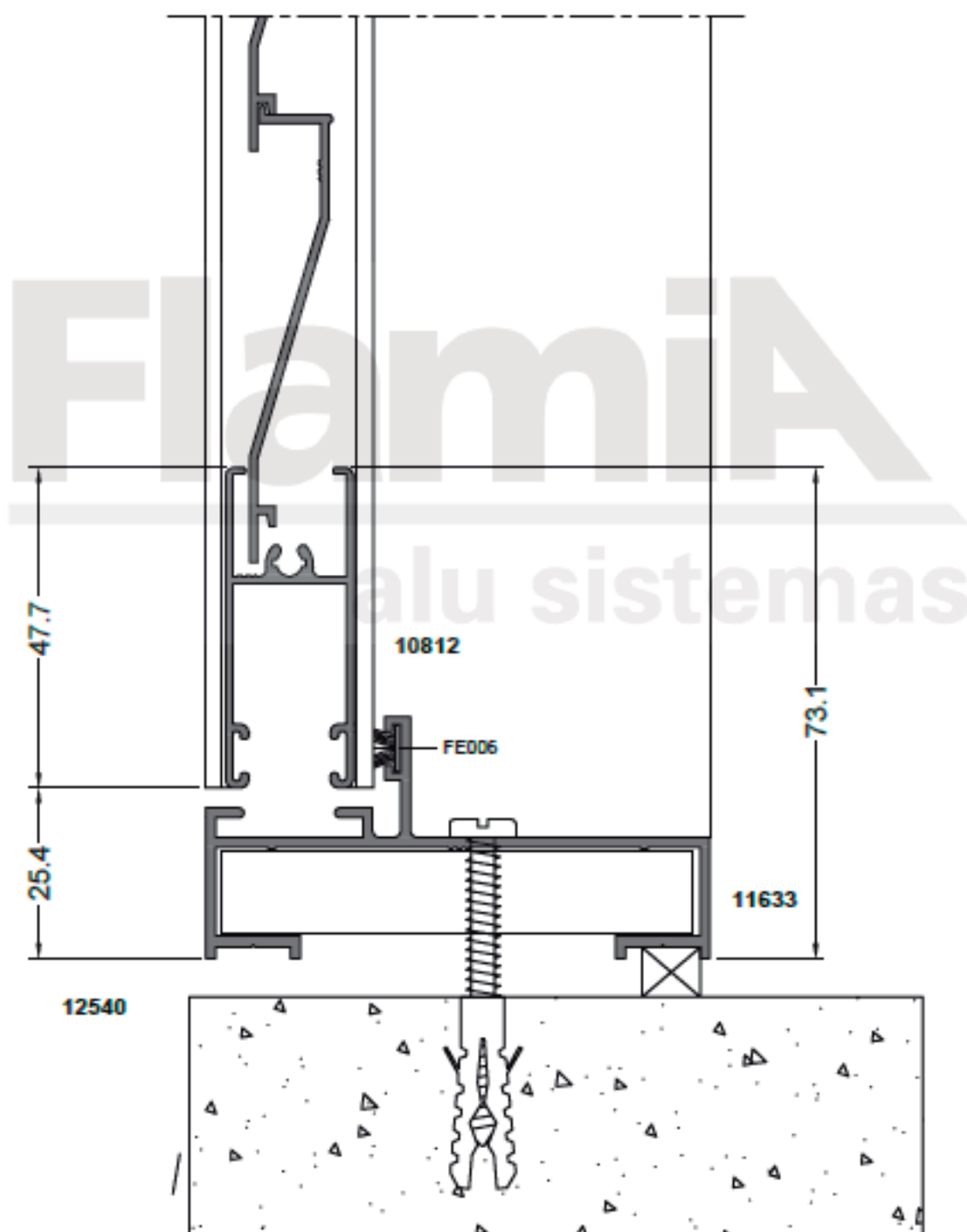
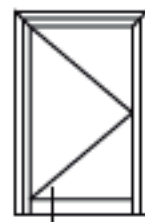

Corte vertical postigón de abrir
Hoja 12204 y marco armado a 45°.

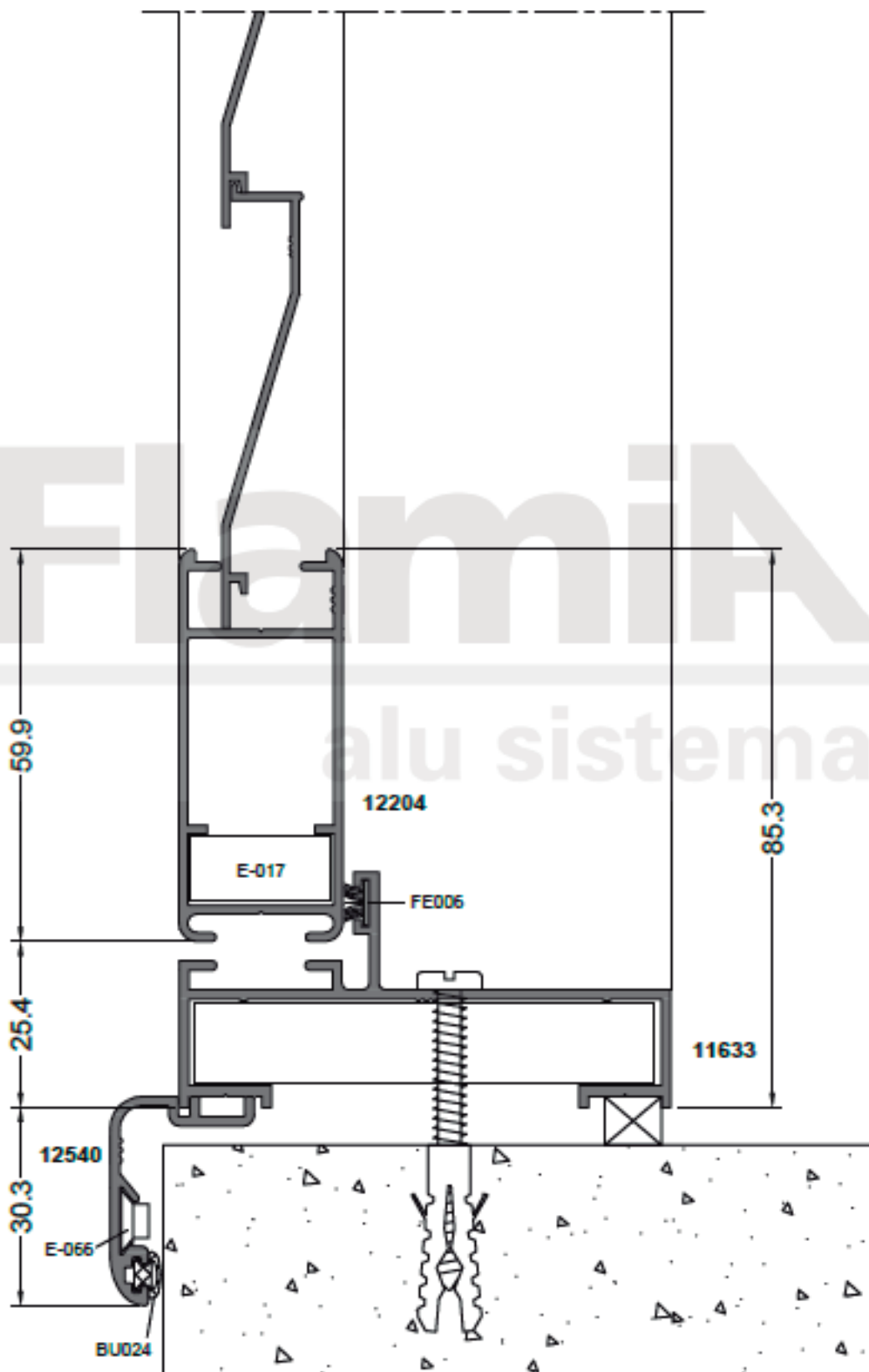

Corte horizontal postigón de abrir
Hoja 11577 y marco 11776.

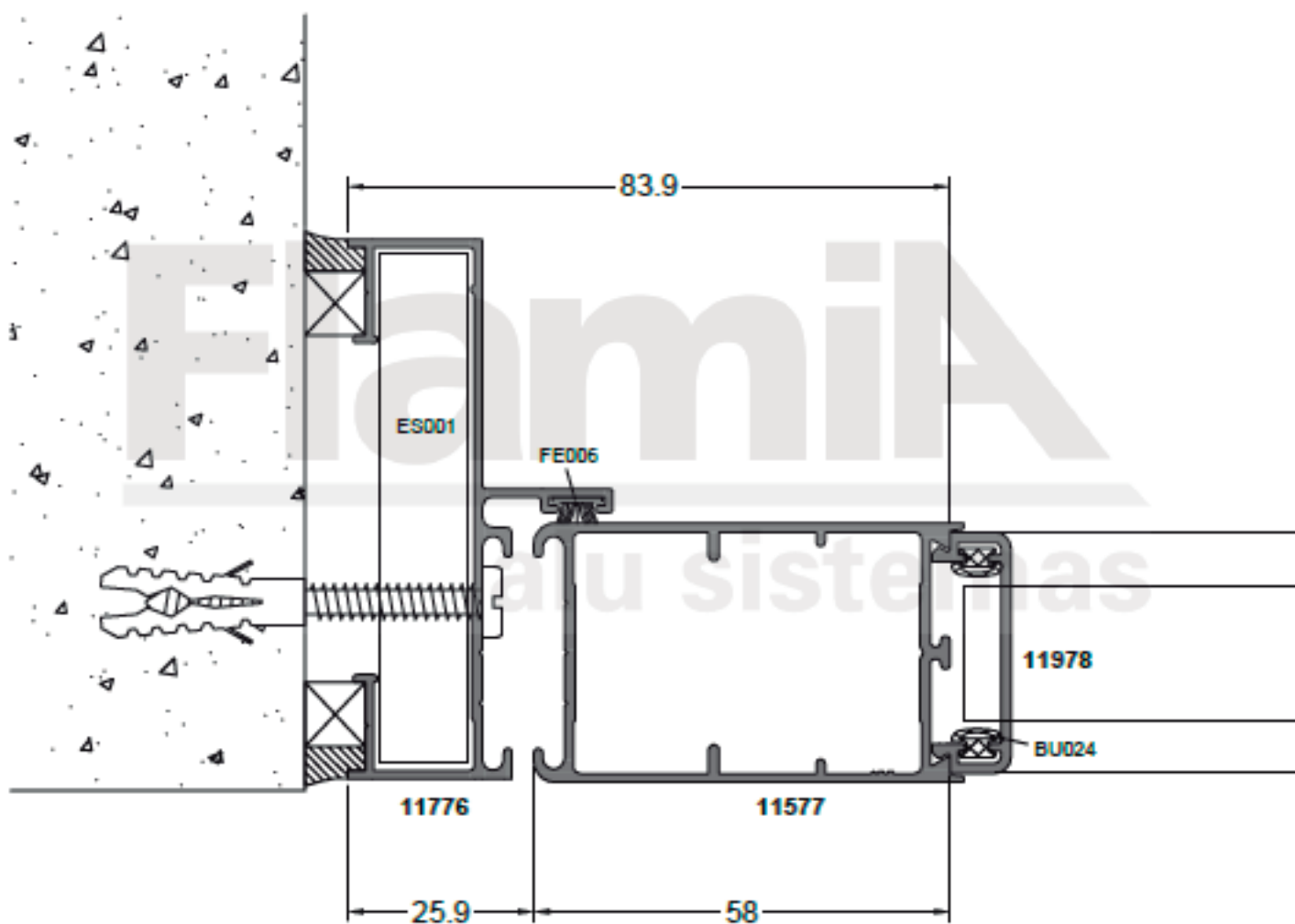

Corte horizontal postigón de abrir 2 hojas
Hoja 11577 y marco 11776.

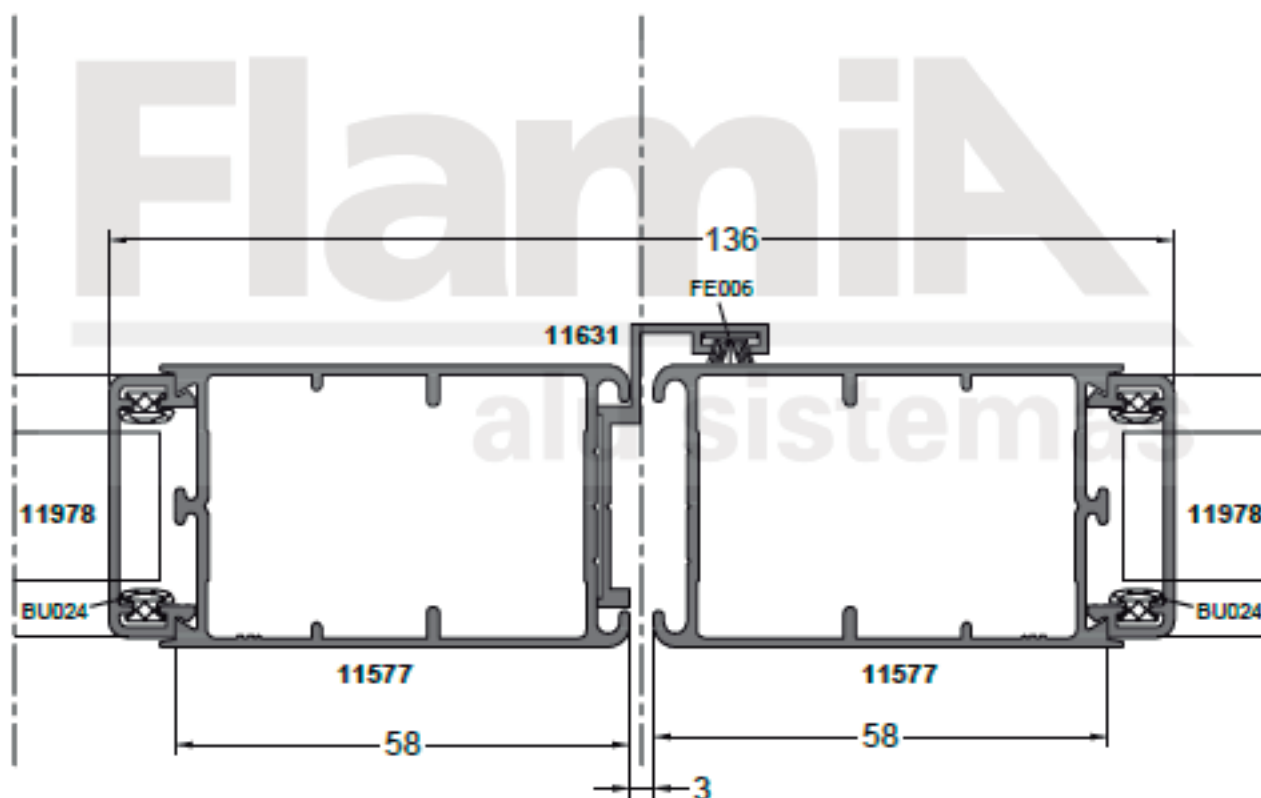
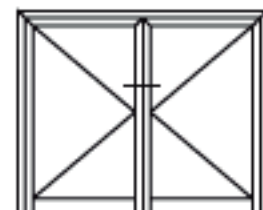

Corte vertical postigón de abrir
Hoja 11577 y marco 11776.

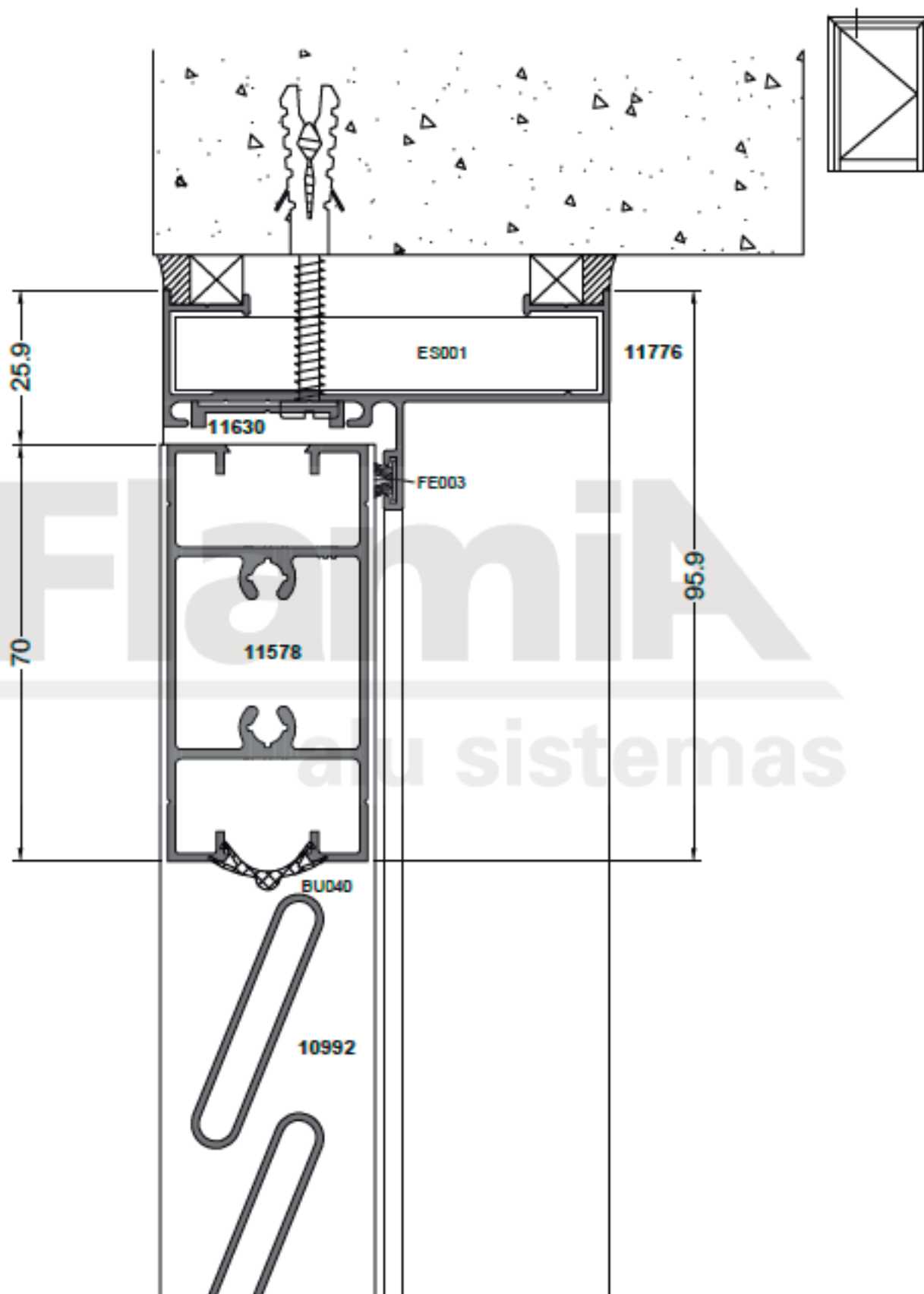

Corte vertical postigón de abrir
Hoja 11577 y marco 11776.

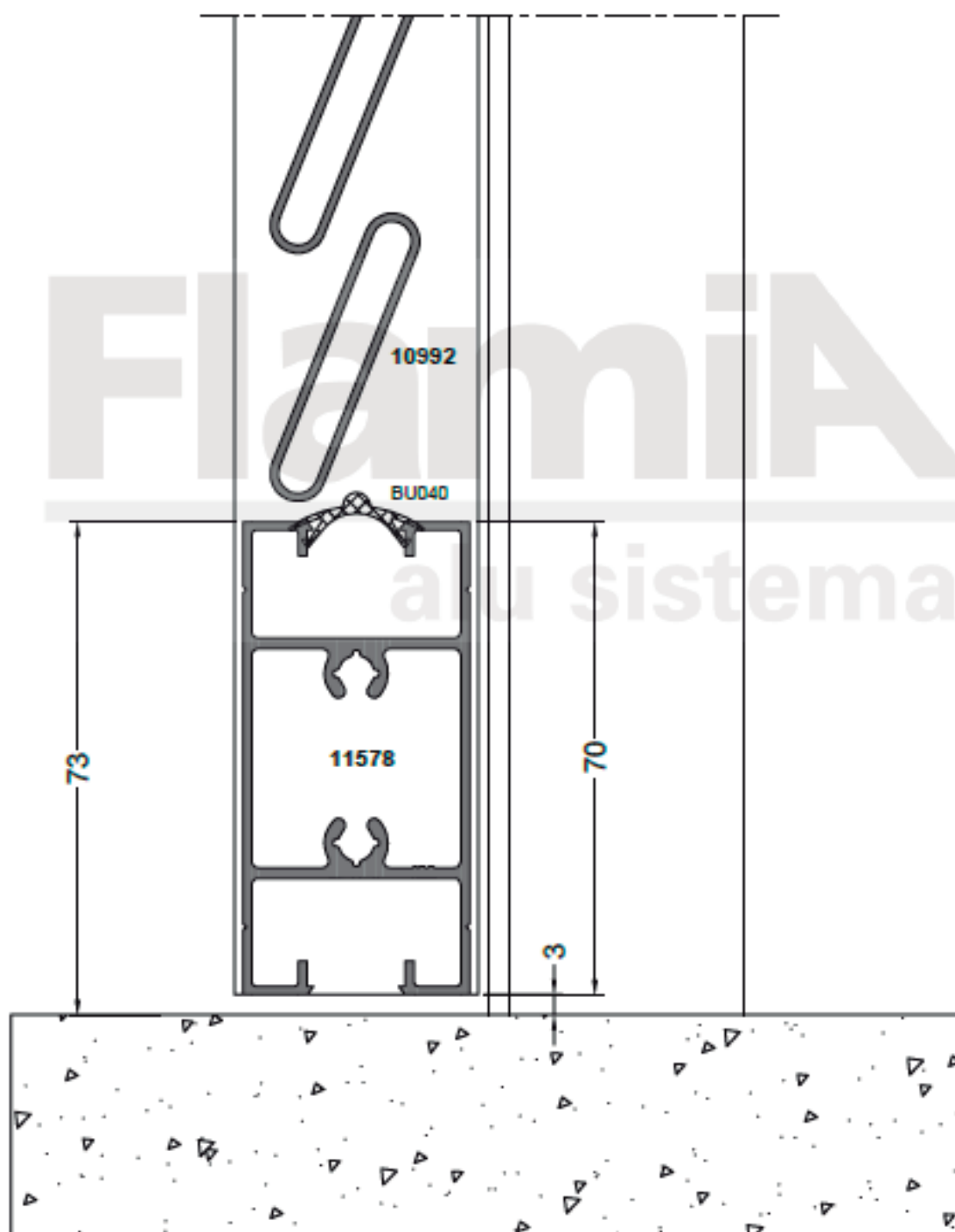
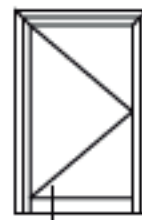

Corte horizontal postigón de abrir
Hoja 14030 y marco 11776.

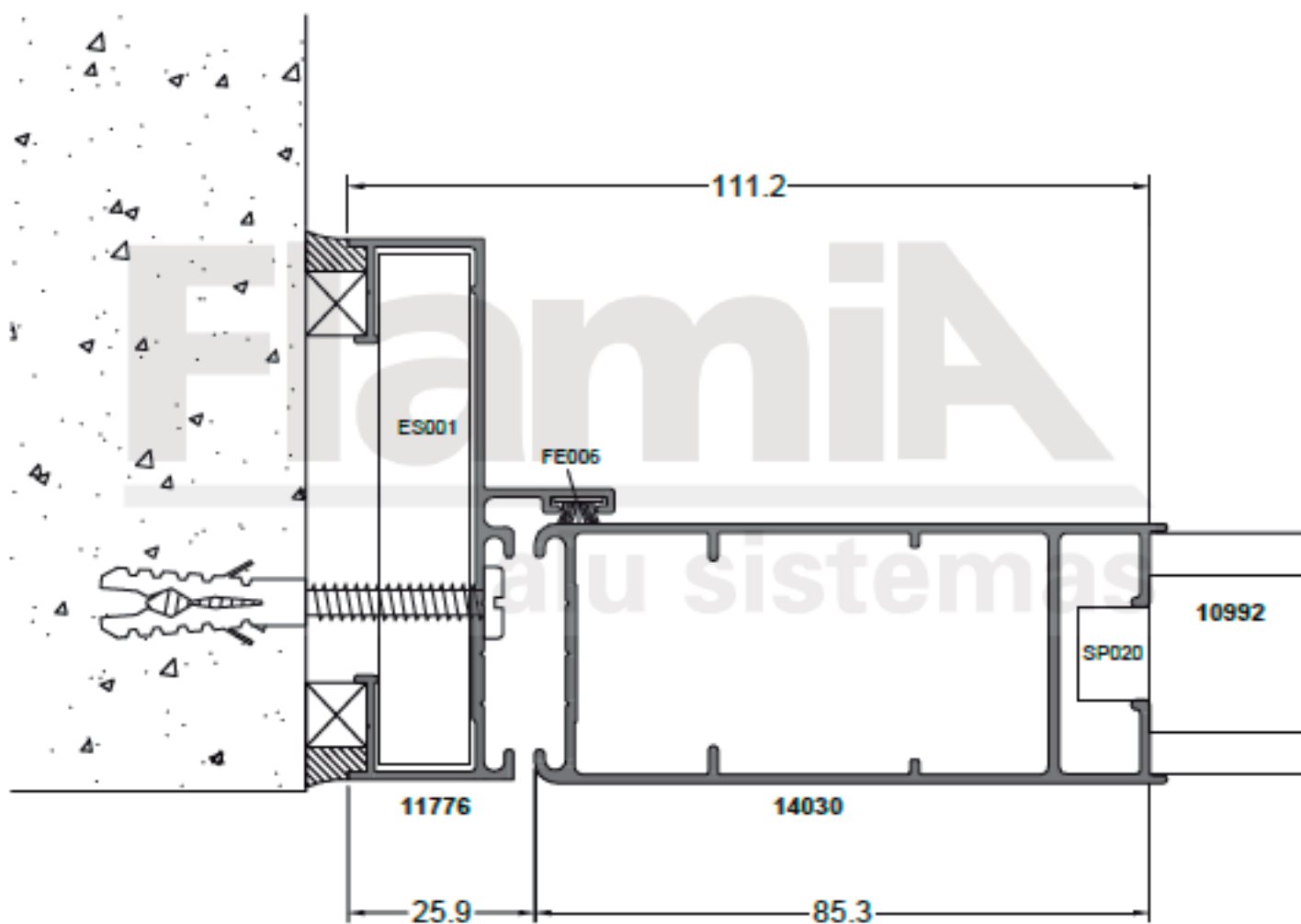
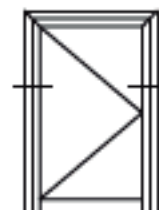

Corte horizontal postigón de abrir 2 hojas
Hoja 14030 y marco 11776.

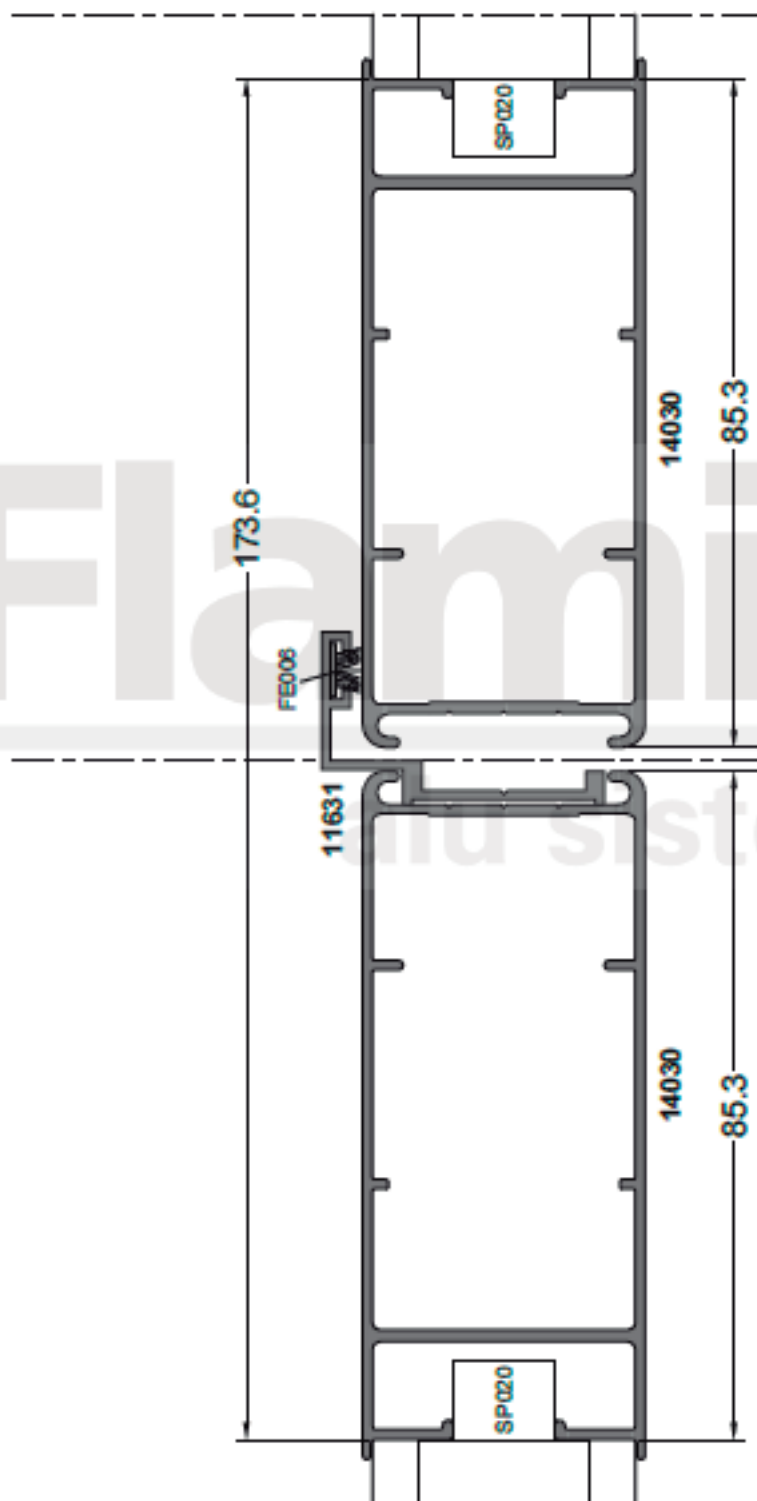

Corte vertical postigón de abrir
Hoja 14030 y marco 11776.

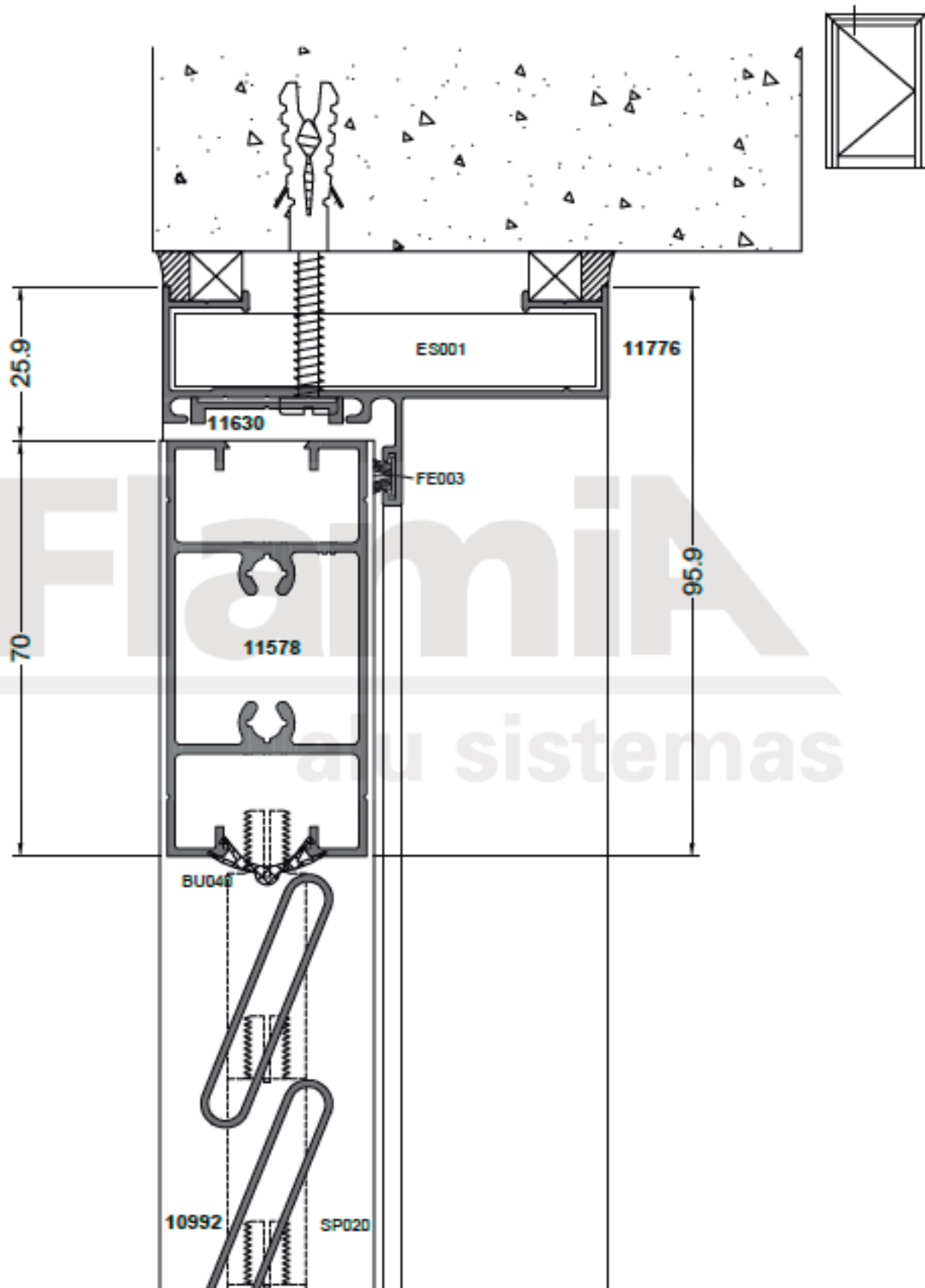



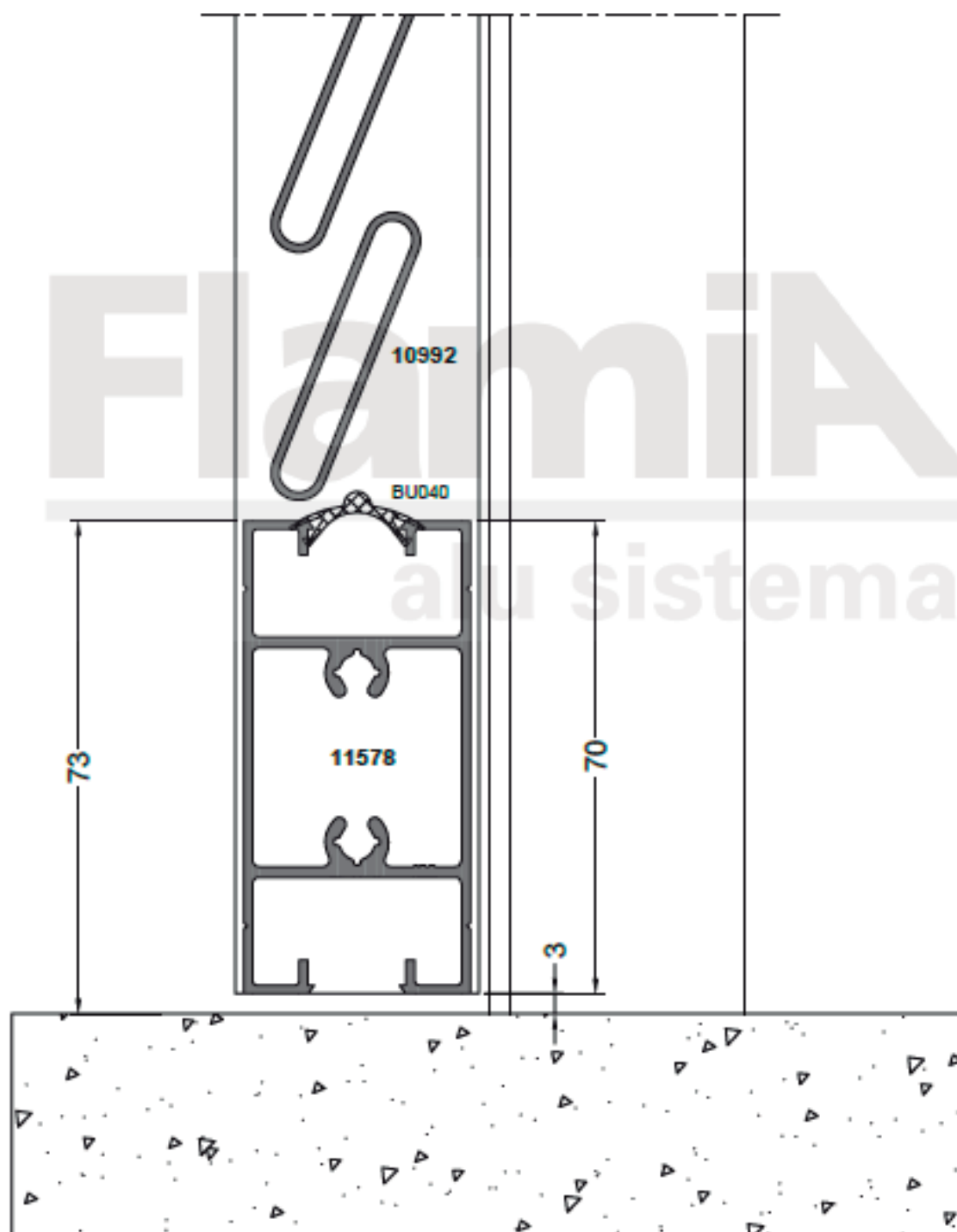
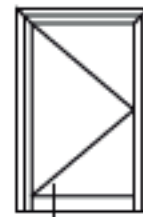





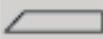

Corte vertical postigón de abrir
Hoja 14030 y marco 11776.

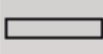

Listado de perfiles (Hoja 12204 armado a 90°)

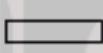

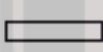
Código	Perfil	Descripción	Peso (kg/m)	Corte	1 Hoja				2 Hojas			
					Horizontal		Vertical		Horizontal		Vertical	
					Cant.	Medida	Cant.	Medida	Cant.	Medida	Cant.	Medida
11633		Marco	0.601		1	A			1	A		
11633		Marco	0.601				2	H			2	H
12204		Postigón hoja	0.668				2	H - 29			2	H - 29
10812/ 99044		Hoja dintel / zócalo	0.393/ 0.871		2	A - 167			4	A/2-144		
11632		Encuentro de hojas	0.224								1	H - 29
11192/ 12152		Tablilla 68 / 77 mm.	0.248/ 0.272			A - 150				A/2-127		











Listado de accesorios básicos

Código	Descripción	Cantidad	
		1 hoja	2 hojas
E-066	Escuadra de alineación tapajunta		4
BU024	Burlate tapajunta	Ancho	2
		Alto	2
ES015	Escuadra para marco		2
FE006	Felpa 7x4,5 mm.	Ancho	1
		Alto	2
BI012 / BI013	Bisagra (Natural, Blanco, Negro)	2	4
AL008	Aldaba de cierre		1
PP001	Pasador a palanca (varilla 200 mm.)		1
PP002	Pasador a palanca (varilla 600 mm.)		1
TR003	Traba postigón		1

FORMULA DE CORTE VALIDA UNICAMENTE PARA LA CONSTRUCCION DE UN PROTOTIPO.
NO APTA PARA PRODUCCION DE ABERTURAS

Listado de perfiles (Hoja 12204 armado a 45°)



Código	Perfil	Descripción	Peso (kg/m)	Corte	1 Hoja				2 Hojas			
					Horizontal		Vertical		Horizontal		Vertical	
					Cant.	Medida	Cant.	Medida	Cant.	Medida	Cant.	Medida
11633		Marco	0.601		2	A	2	H	2	A	2	H
12204		Postigón hoja	0.668		2	A - 51	2	H - 51	4	A/2 - xx	4	H - 51
11632		Encuentro de hojas	0.224								1	H - 51
12152/ 12351		Tablilla 77 mm.	0.248			A - 150				A/2-127		
11192/ 11199		Tablilla 68 mm.	0.272			A - 150				A/2-127		









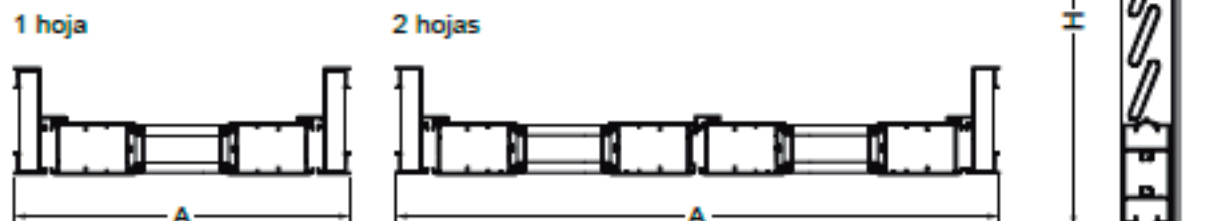



Listado de accesorios básicos

Código	Descripción	Cantidad	
		1 hoja	2 hojas
E-066	Escuadra de alineación tapajunta	4	
BU024	Burlate tapajunta	Ancho	2
		Alto	2
ES015	Escuadra para marco	4	
E-017	Escuadra para hoja	4	8
FE008	Felpa 7x4,5 mm.	Ancho	2
		Alto	3
BI012 / BI013	Bisagra (Natural, Blanco, Negro)	2	4
AL008	Aldaba de cierre	1	
PP001	Pasador a palanca (varilla 200 mm.)	1	
PP002	Pasador a palanca (varilla 600 mm.)	1	
TR003	Traba postigón	1	

FORMULA DE CORTE VALIDA UNICAMENTE PARA LA CONSTRUCCION DE UN PROTOTIPO.
NO APTA PARA PRODUCCION DE ABERTURAS

Listado de perfiles (Hoja 11577 y marco 11776)



Código	Perfil	Descripción	Peso (kg/m)	Corte	1 Hoja				2 Hojas			
					Horizontal		Vertical		Horizontal		Vertical	
					Cant.	Medida	Cant.	Medida	Cant.	Medida	Cant.	Medida
11776		Marco	0.565		1	A			1	A		
11776		Marco	0.565				2	H			2	H
11577		Hoja	0.750				2	H - 29			4	H - 29
11578		Umbral y zócalo	1.080		2	A - 168			4	A/2-143		
11867/ 11978		Soporte tablilla 10992	0.227/ 0.190				2	H - 169			4	H - 169
11630		Tapacanto	0.110		1	A - 46	2	H - 23	1	A - 46	2	H - 23
11631		Tapa umbral	0.144								1	H - 29
10992		Tablilla	0.300			A - 172				A/2-148		

Listado de accesorios básicos

Código	Descripción	Cantidad		
		1 hoja	2 hojas	
ES001	Escuadra para marco	4		
BI014 - BI015	Bisagra Natural / Blanco / Negro	3	6	
PI004	Picaporte con bocallave regulable Blanco / Negro	1		
PI006	Picaporte con recuperación automática Blanco / Negro	1		
CE001	Cerradura (Kallay 3001)	1		
CE002	Cerradura (Kallay 4006)	1		
PP001	Pasador a palanca con varilla corta (200 mm.)	1		
PP002	Pasador a palanca con varilla larga (600 mm.)	1		
PP003	Pasador GM doble	1		
BU024	Burlete para soporte tablilla	Alto	4	8
BU040	Burlete para 11578	Ancho	2	
BU038	Burlete tapacanto (opción al perfil 11630)	Ancho	1	
		Alto	2	
FE006	Felpa 7x4.5 mm.	Ancho	1	
		Alto	2	3





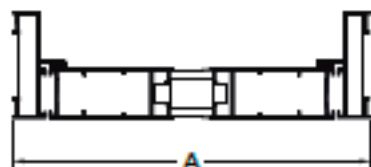



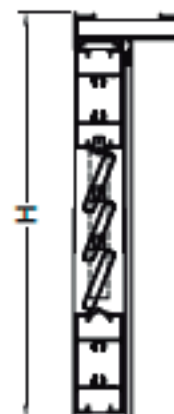



Listado de perfiles (Hoja 14030 y marco 11776)

1 hoja



2 hojas



Código	Perfil	Descripción	Peso (kg/m)	Corte	1 Hoja				2 Hojas			
					Horizontal		Vertical		Horizontal		Vertical	
					Cant.	Medida	Cant.	Medida	Cant.	Medida	Cant.	Medida
11776		Marco	0.565		1	A			1	A		
11776		Marco	0.565				2	H			2	H
14030		Hoja	0.972				2	H - 29			4	H - 29
11578		Umbral y zócalo	1.080		2	A - 222			4	A/2-199		
11631		Tapa umbral	0.144								1	H - 29
10992		Tablilla	0.300			A - 222				A/2-199		

Listado de accesorios básicos

Código	Descripción	Cantidad	
		1 hoja	2 hojas
ES001	Escuadra para marco	4	
BI014 - BI015	Bisagra Natural / Blanco / Negro	3	6
SP020	Soporte para tablilla	2 x Tablilla	
PI004	Picaporte con bocallave regulable Blanco / Negro	1	
PI006	Picaporte con recuperación automática Blanco / Negro	1	
CE001	Cerradura (Kallay 3001)	1	
CE002	Cerradura (Kallay 4006)	1	
CE003	Cerradura doble perno (Kallay 4002)	1	
PP001	Pasador a palanca con varilla corta (200 mm.)		1
PP002	Pasador a palanca con varilla larga (600 mm.)		1
PP003	Pasador GM doble		1
BU040	Burlete para 11578	Ancho	2
BU038	Burlete tapacanto (opción al perfil 11630)	Ancho	1
		Alto	2
FE006	Felpa 7x4.5 mm.	Ancho	1
		Alto	2
BU008 - BU009 - BU010	Burlete cuña chica - mediana - grande	Ancho	4
		Alto	4

SISTEMAS DE CARPINTERIA

Standard

PARASOL



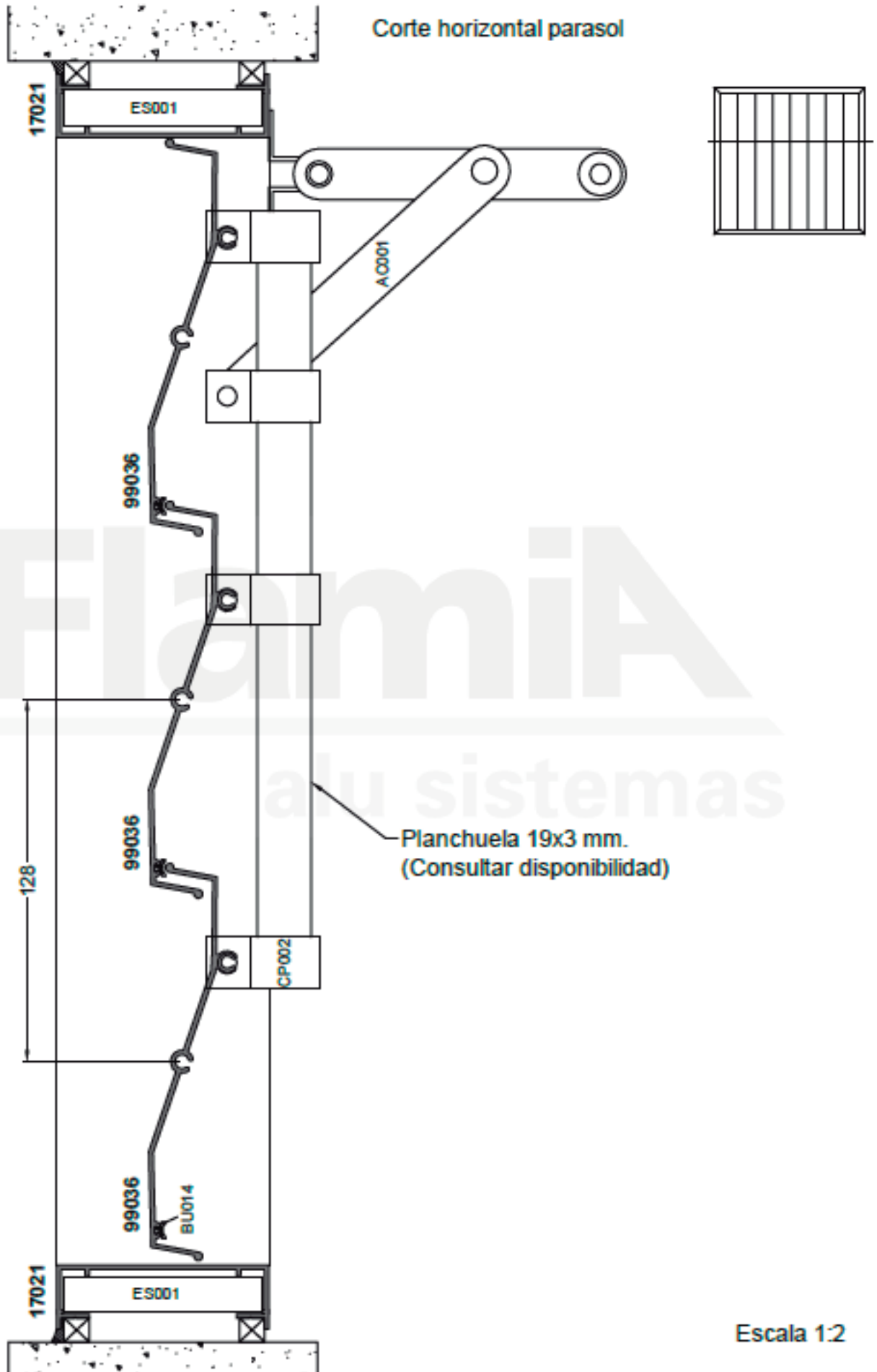

Corte vertical parasol



FlamiA
alu sistemas

Escala 1:2

SISTEMAS DE CARPINTERIA

Standard

FRENTE VIDRIERA

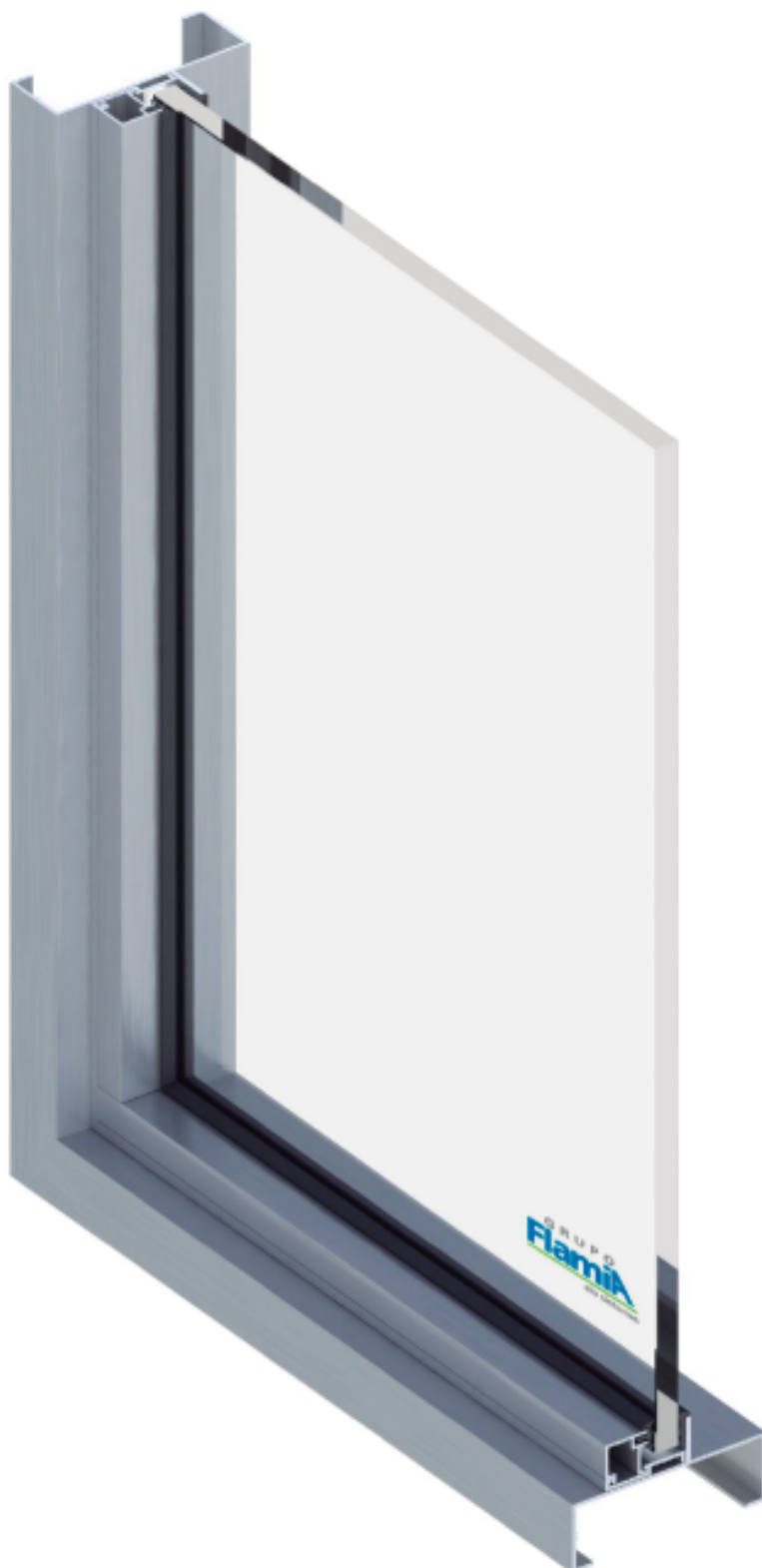

Corte horizontal frente vidriera
Marco 75x25 mm.

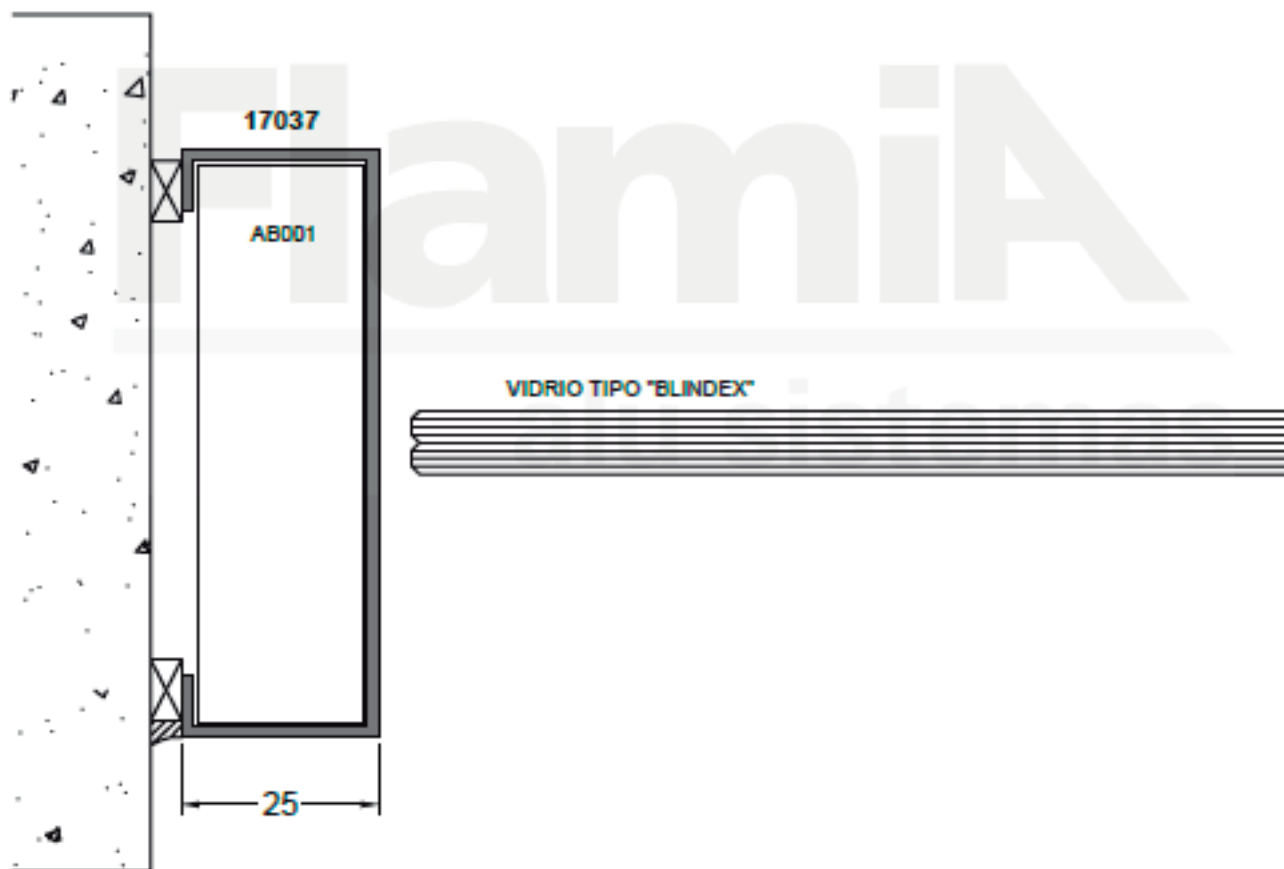
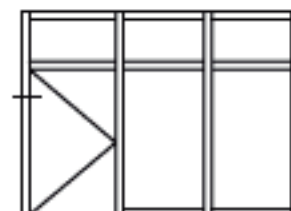

Corte horizontal frente vidriera
Marco 75x25 mm.

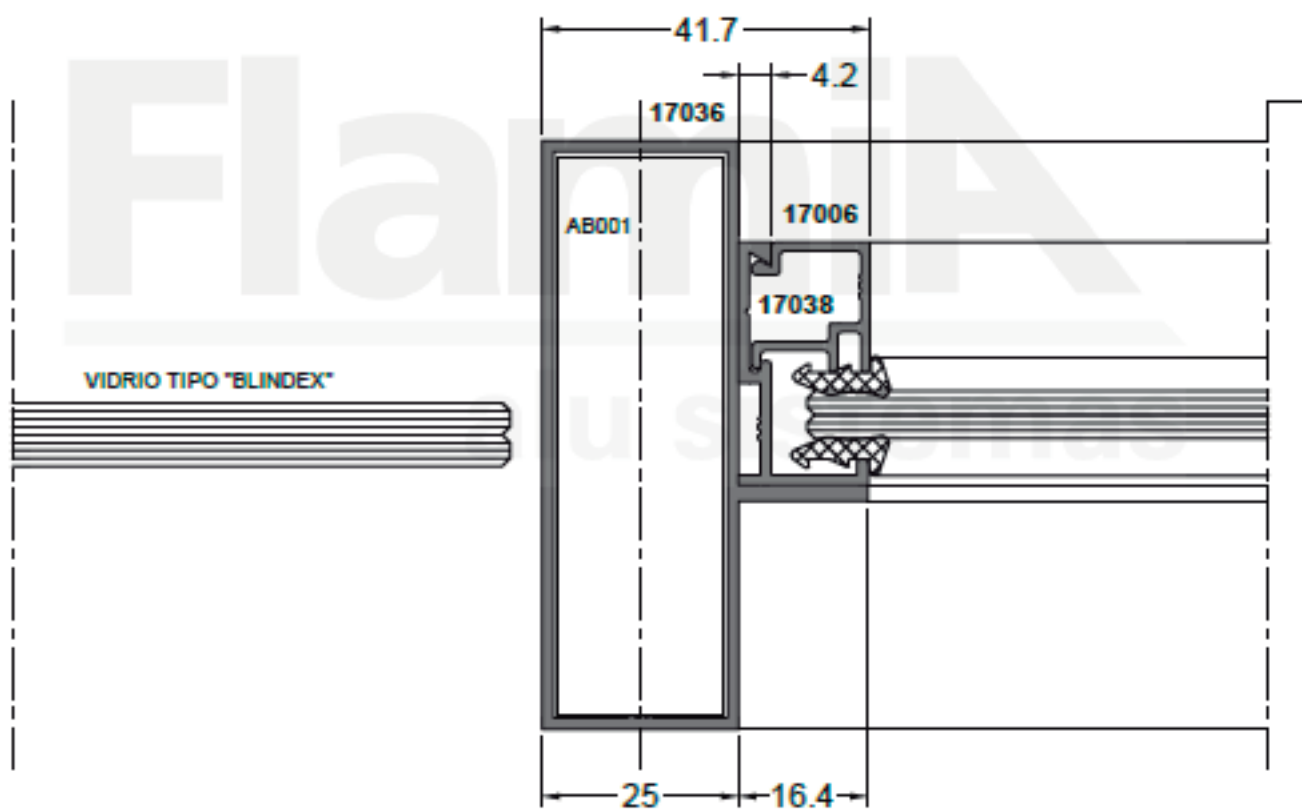
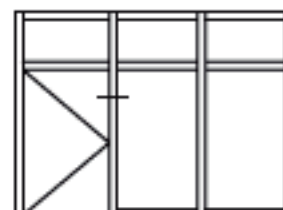

Corte horizontal frente vidriera
Marco 75x25 mm.

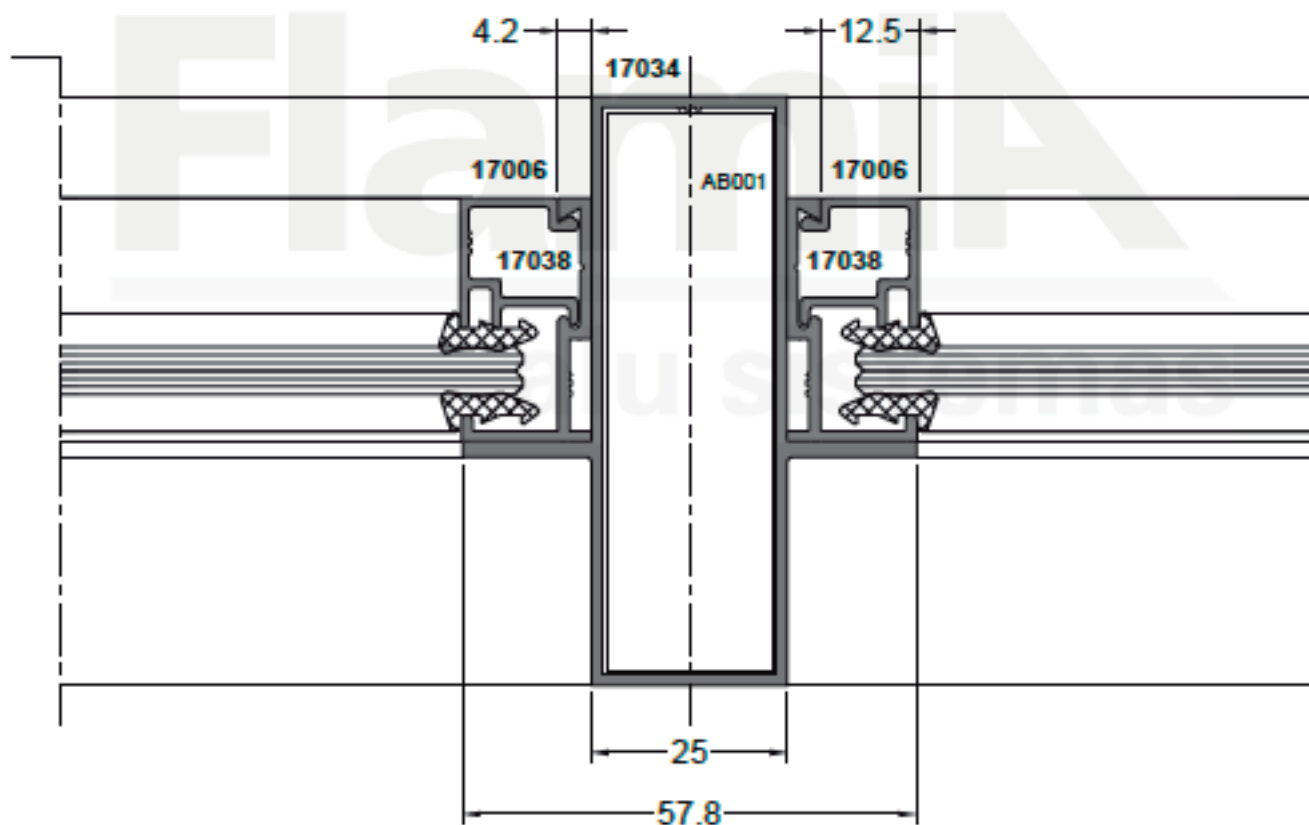
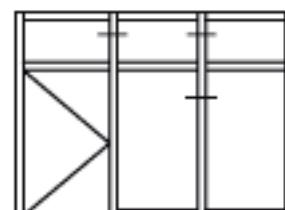

Corte horizontal frente vidriera
Marco 75x25 mm.

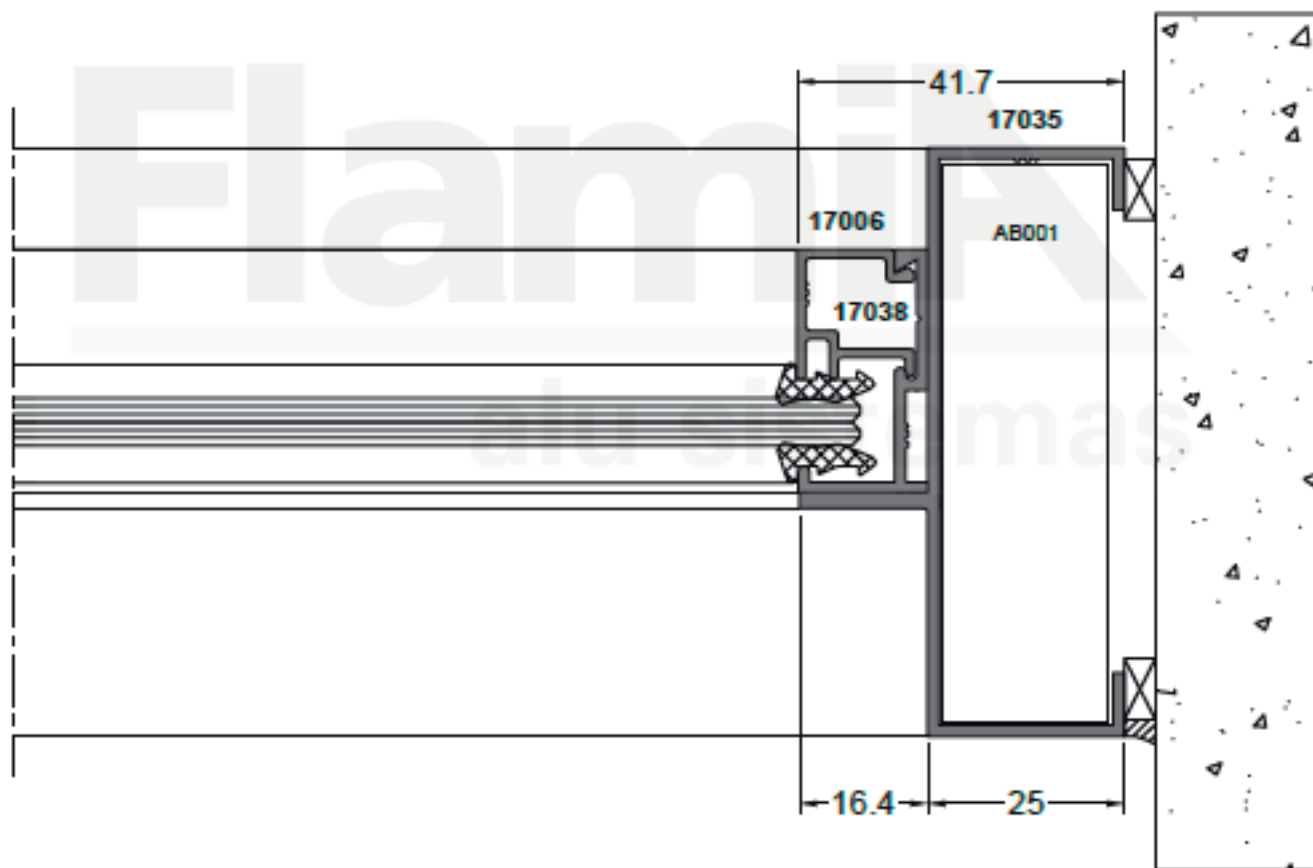
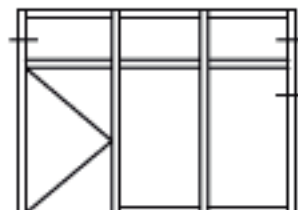

Corte vertical frente vidriera
Marco 75x25 mm.

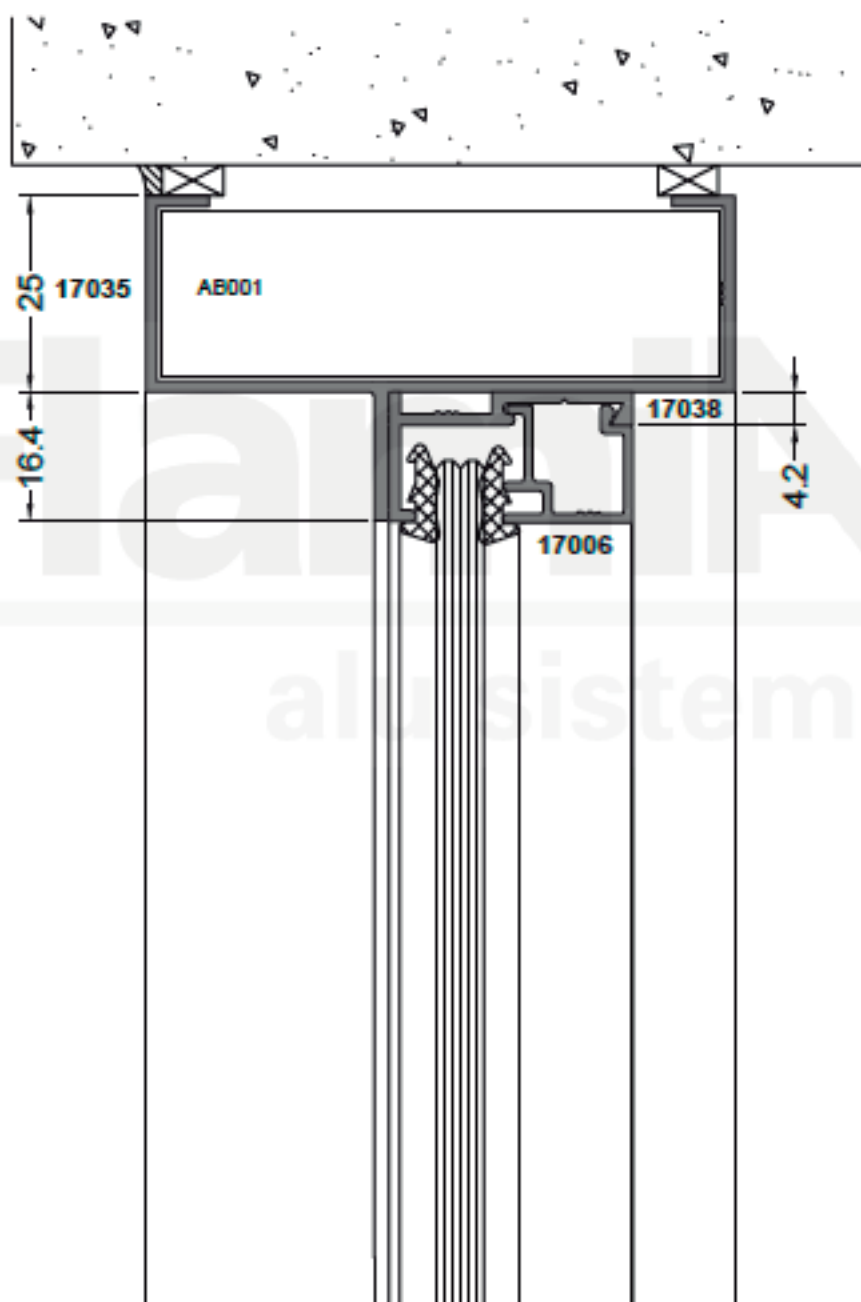
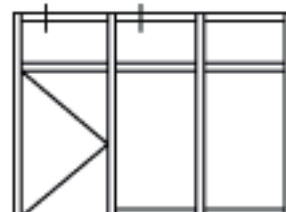

Fla...
al... sistemas

Corte vertical frente vidriera
Marco 75x25 mm.

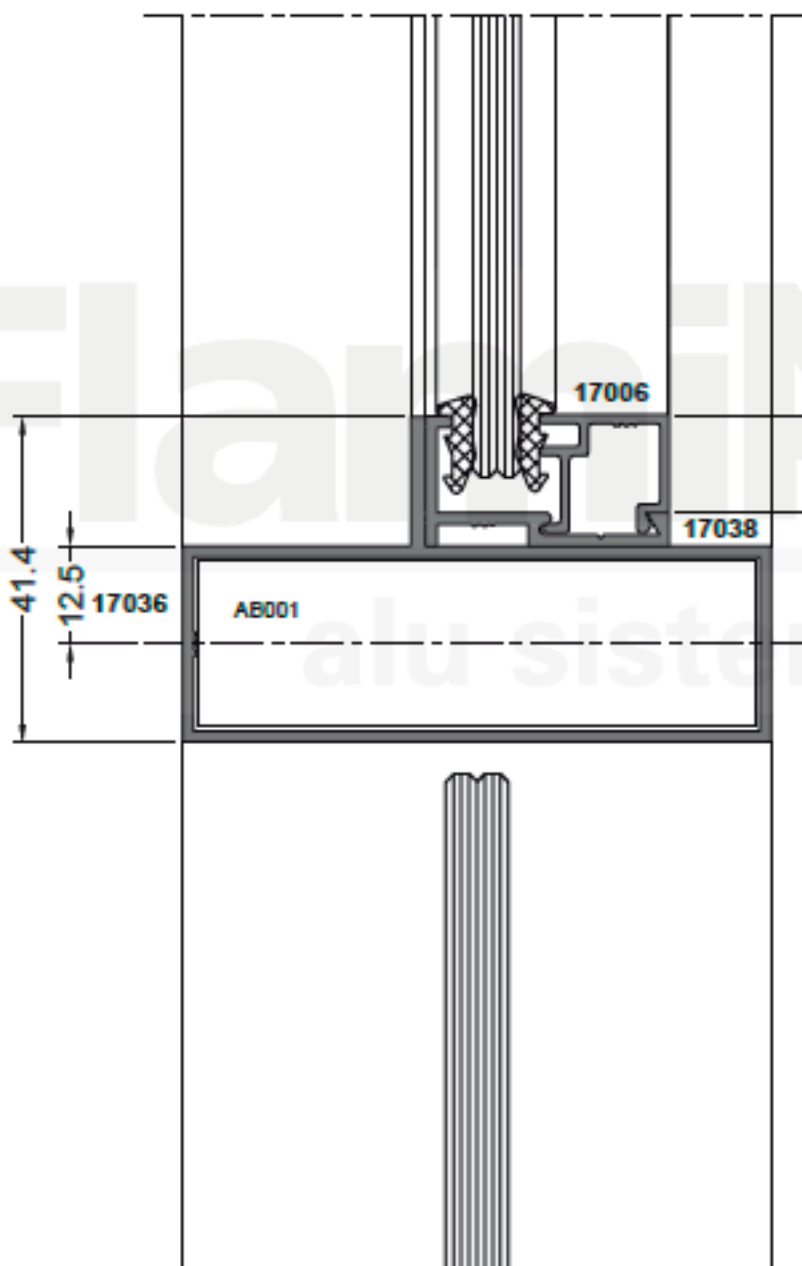
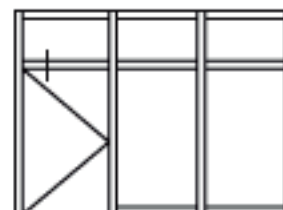

Corte vertical frente vidriera
Marco 75x25 mm.

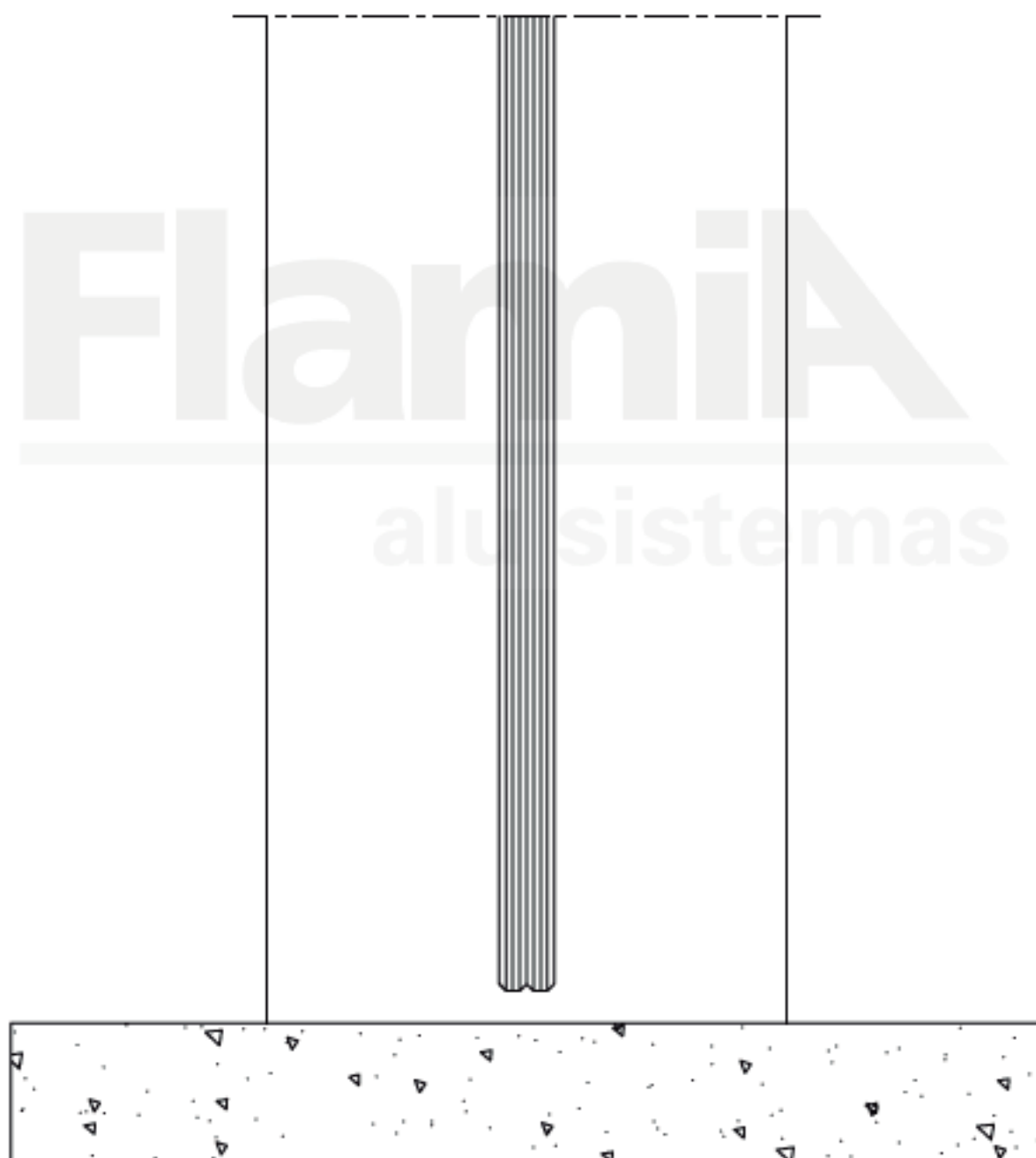
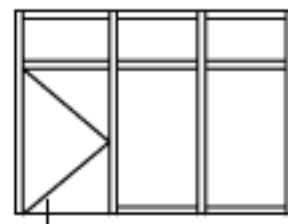

Corte vertical frente vidriera
Marco 75x25 mm.

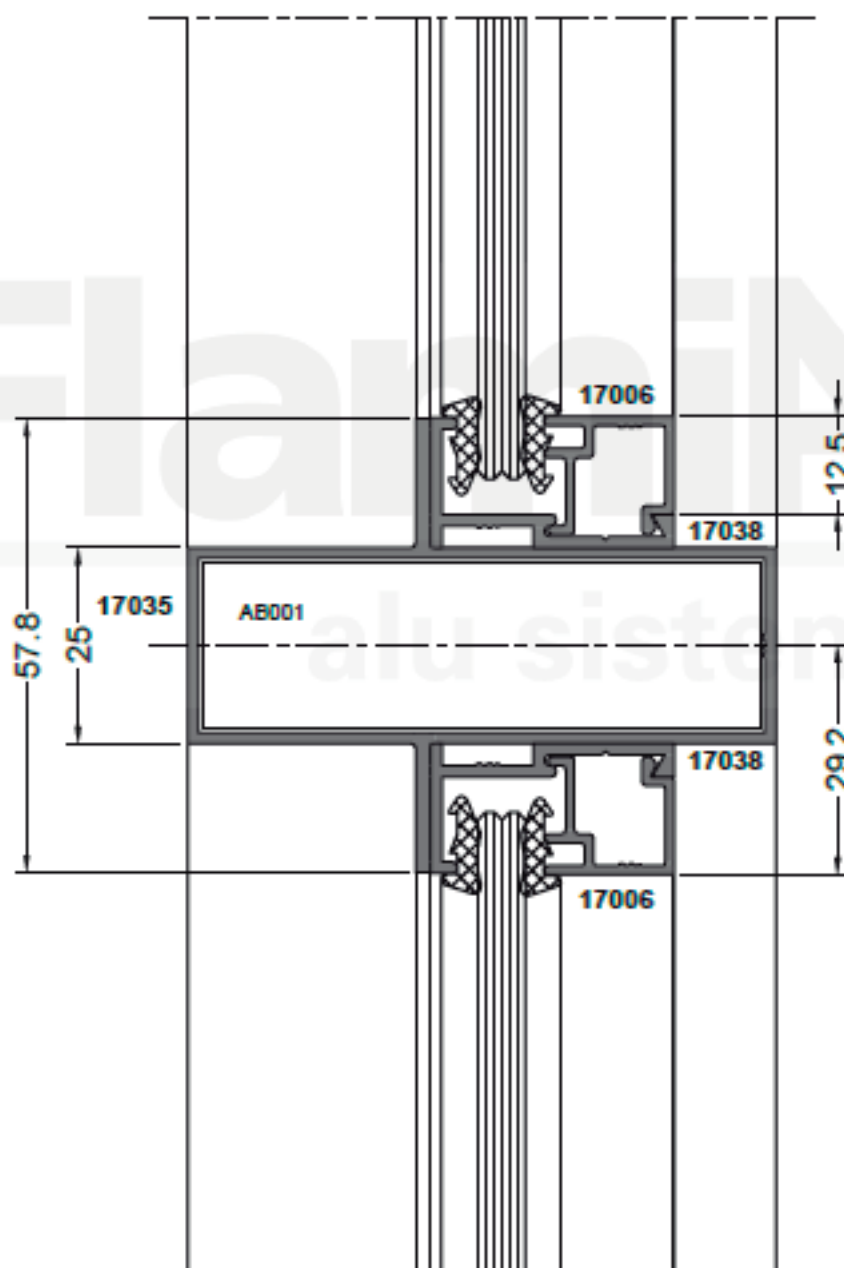
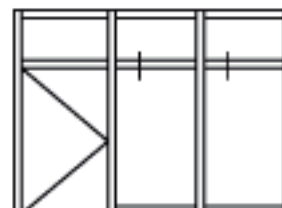

Corte horizontal frente vidriera
Marco 90x40 mm.

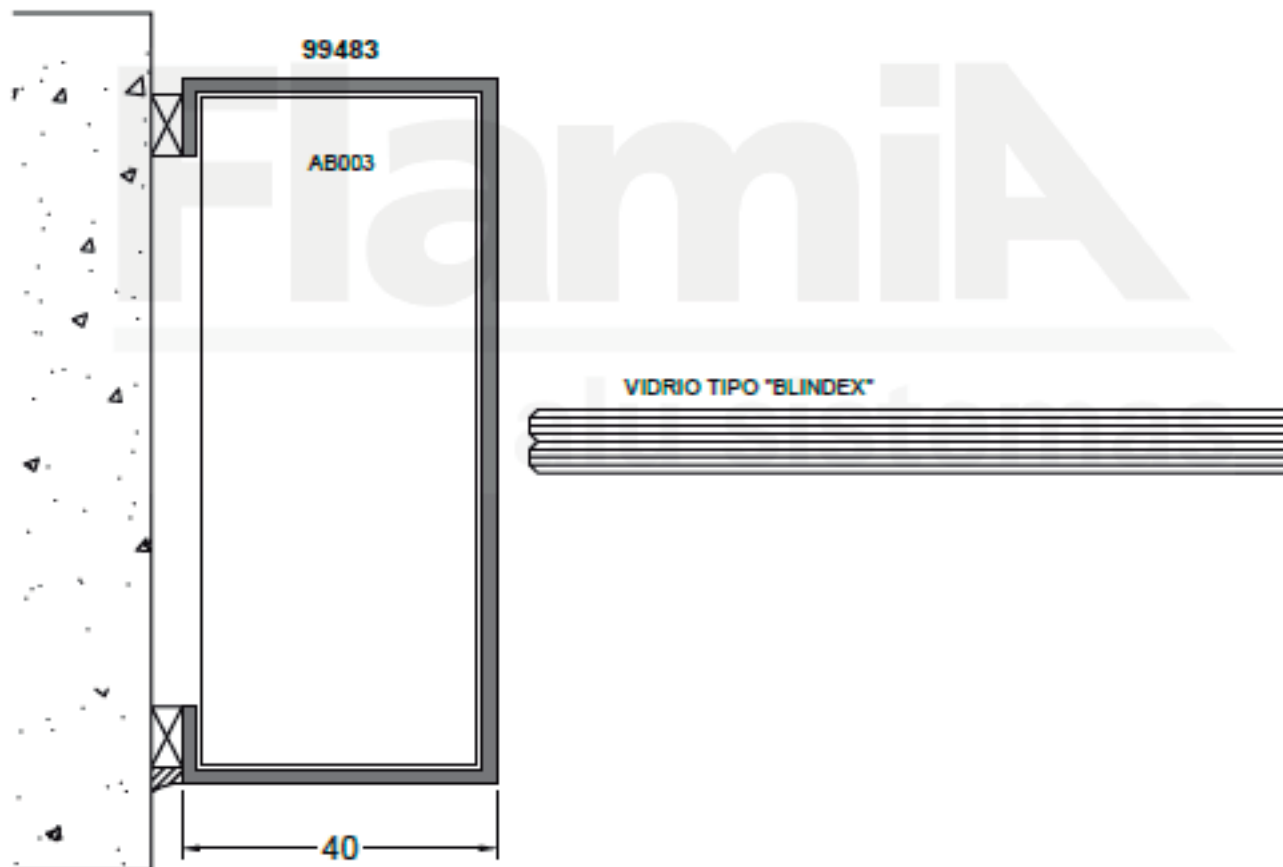
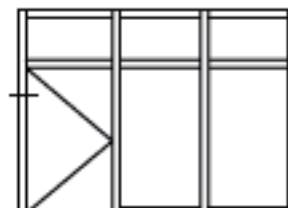

Corte horizontal frente vidriera
Marco 90x40 mm.

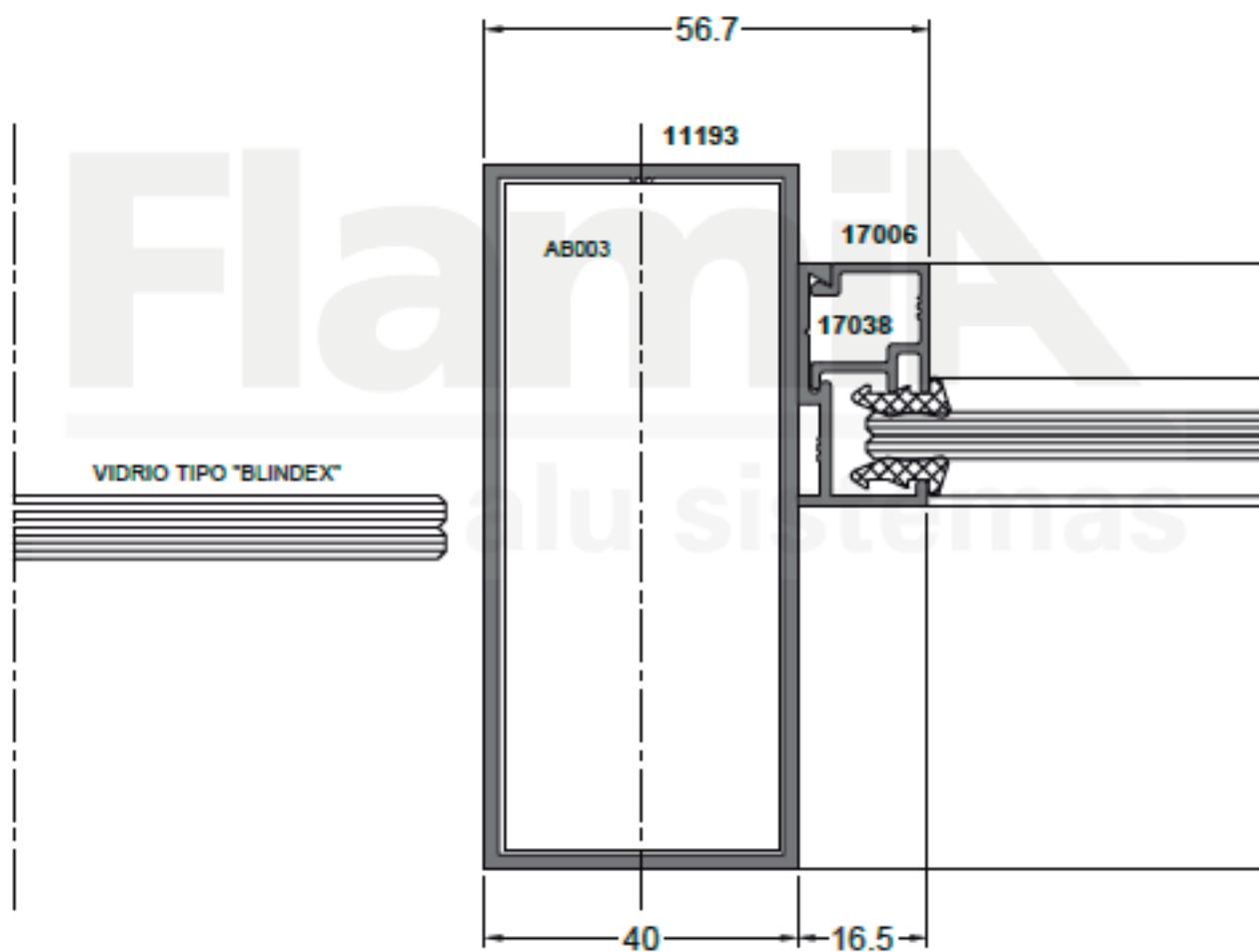
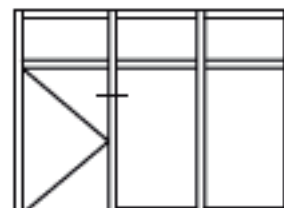

Corte horizontal frente vidriera
Marco 90x40 mm.

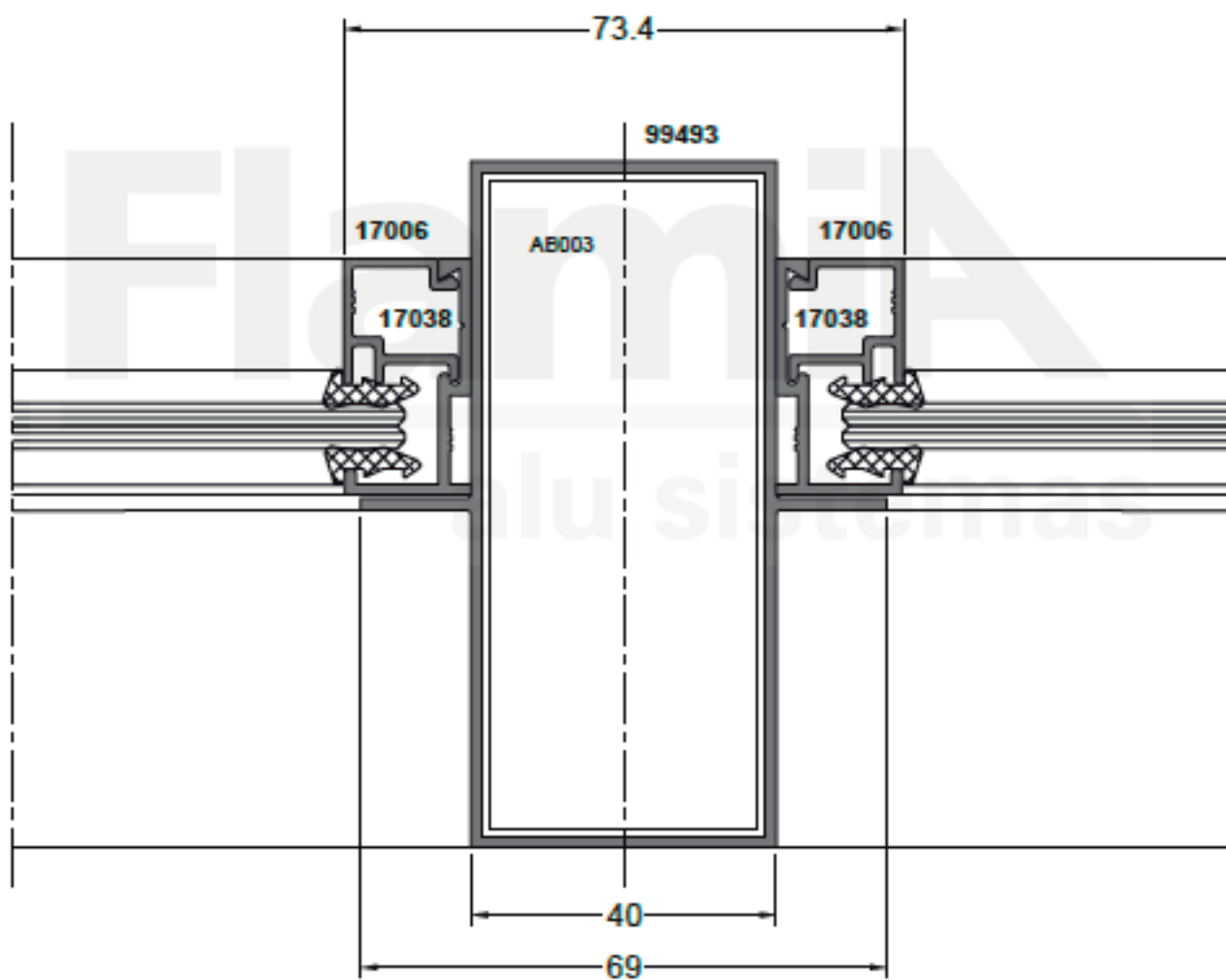
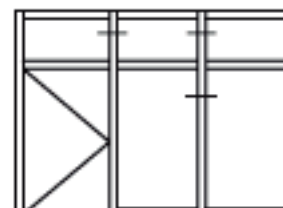

Corte horizontal frente vidriera
Marco 90x40 mm.

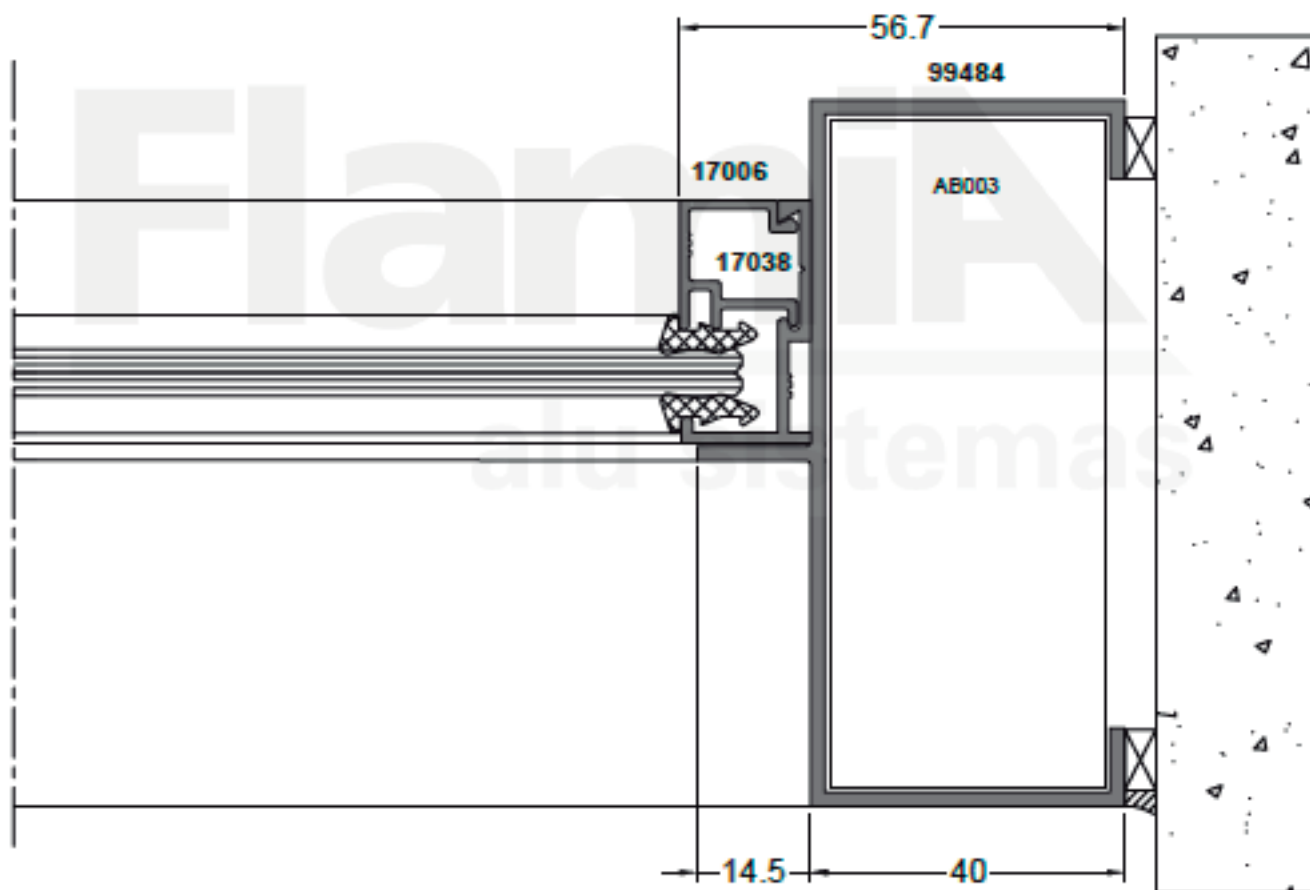
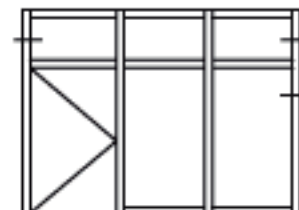

Corte vertical frente vidriera
Marco 90x40 mm.

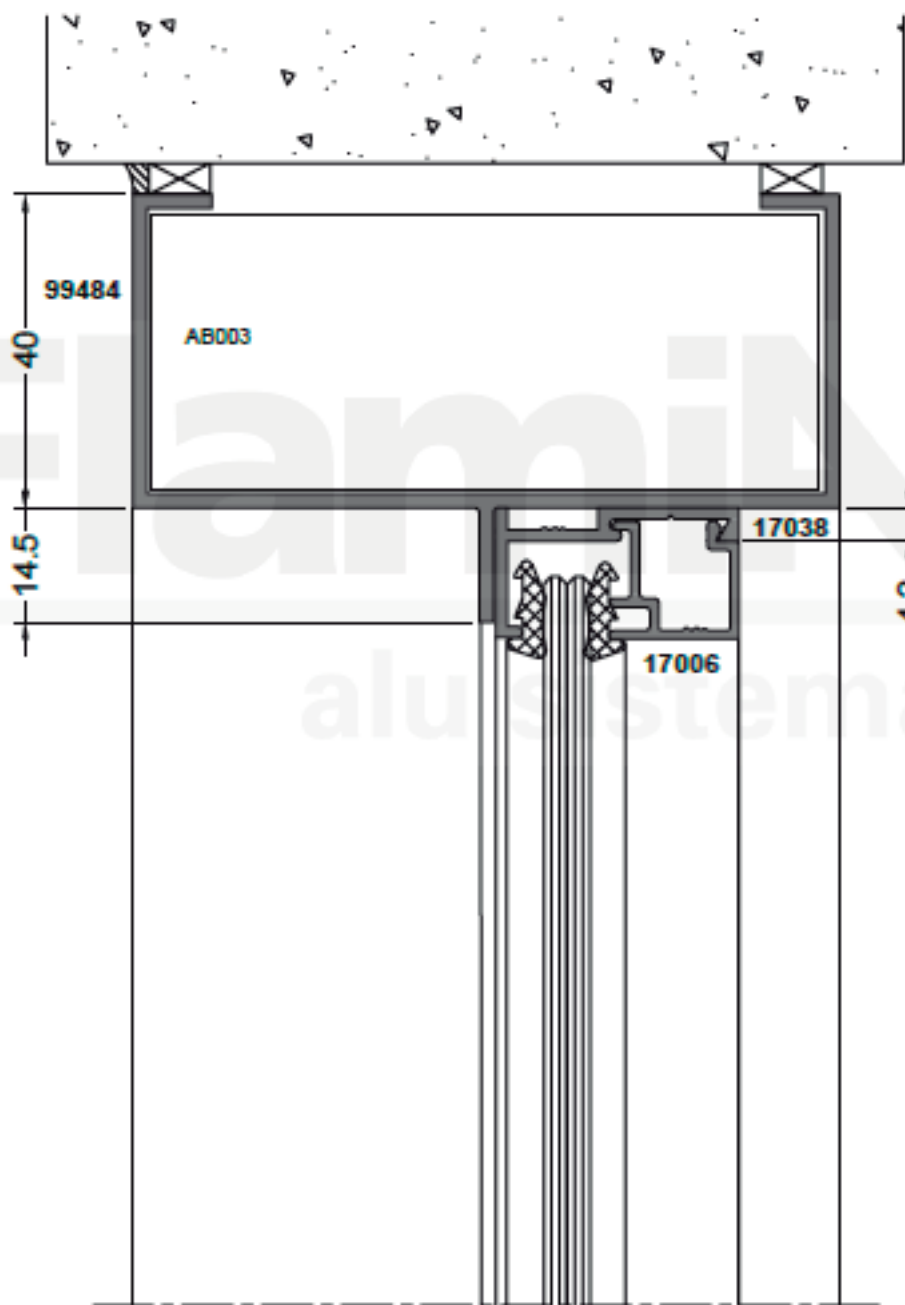
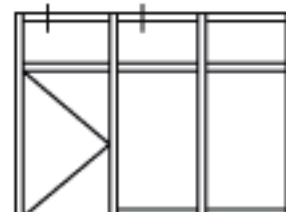

Corte vertical frente vidriera
Marco 90x40 mm.

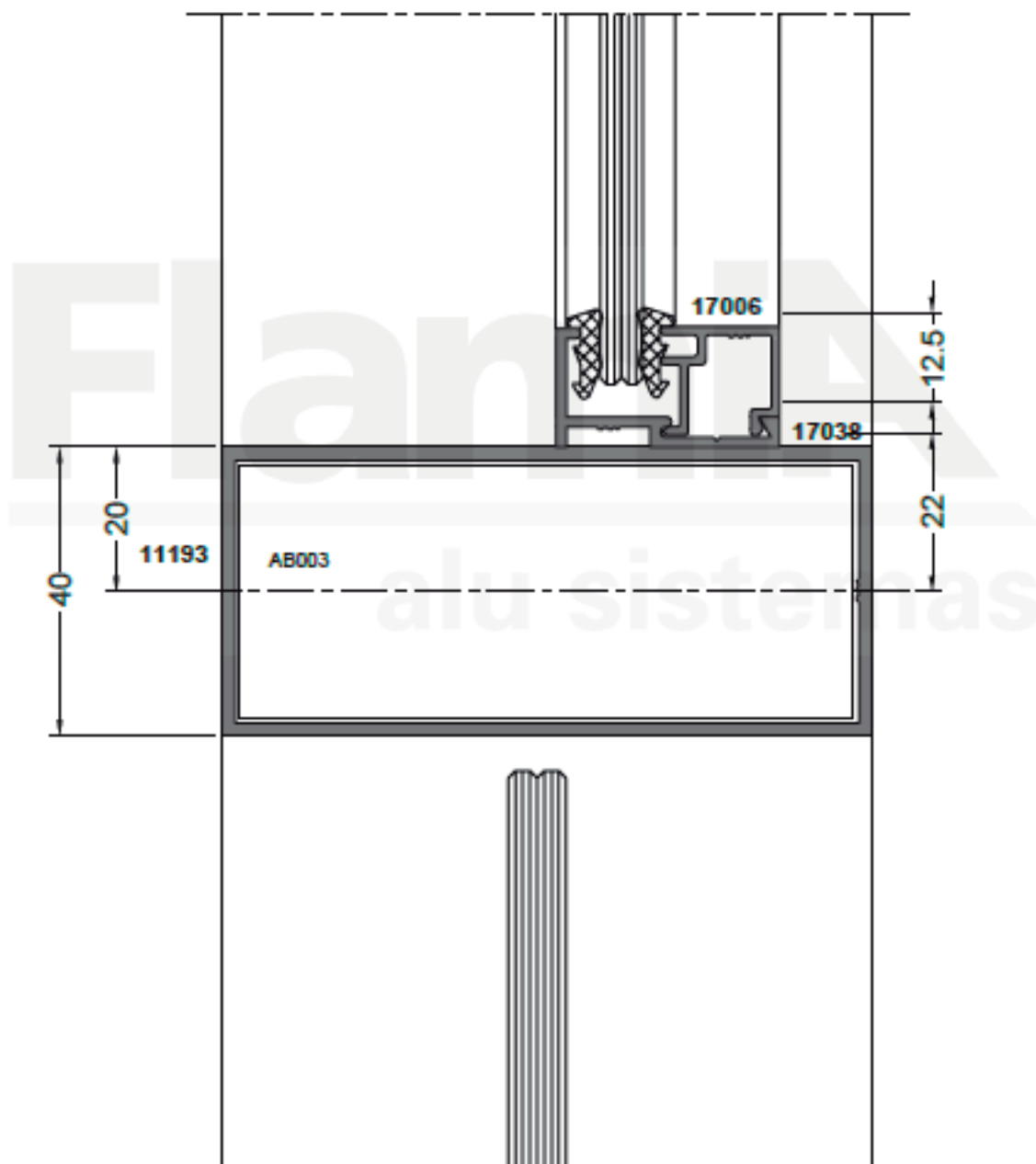
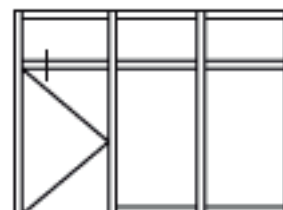

Corte vertical frente vidriera
Marco 90x40 mm.

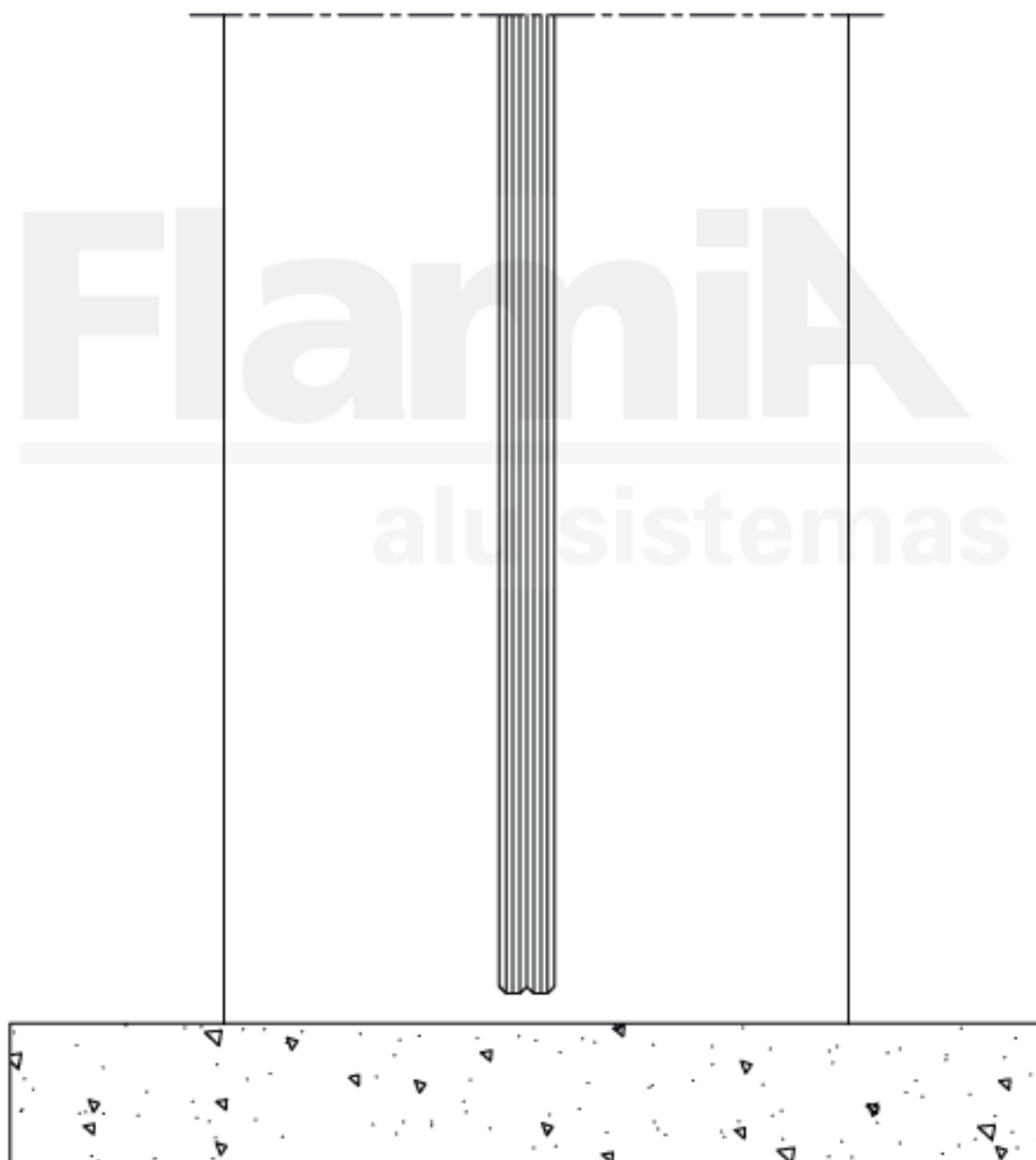
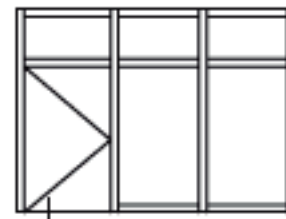

FlaminiA
aluminum systems

Corte vertical frente vidriera
Marco 90x40 mm.

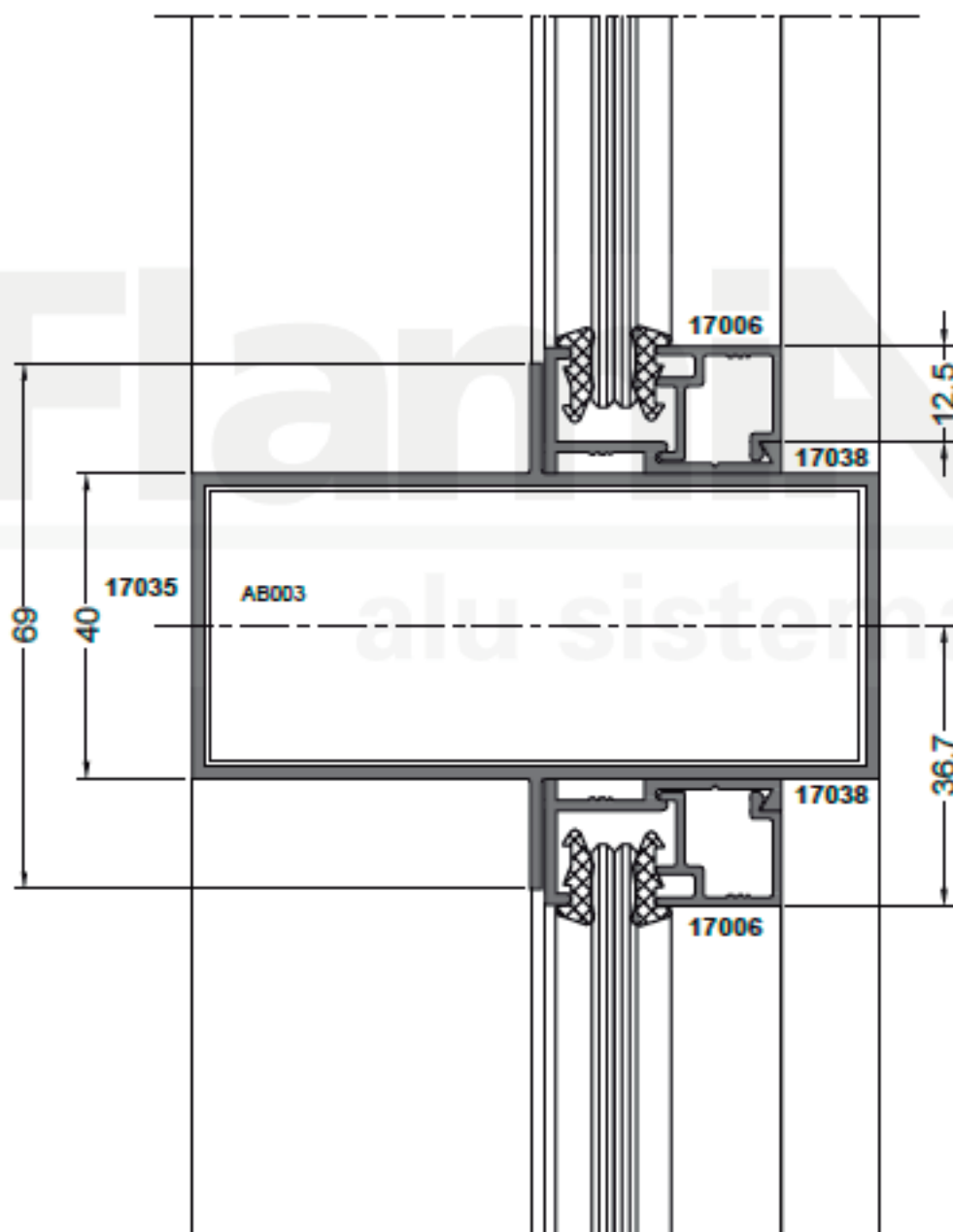
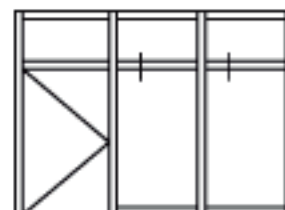

SISTEMAS DE CARPINTERIA

Standard

CORTINA DE ENROLLAR



Corte horizontal guia para cortina común.

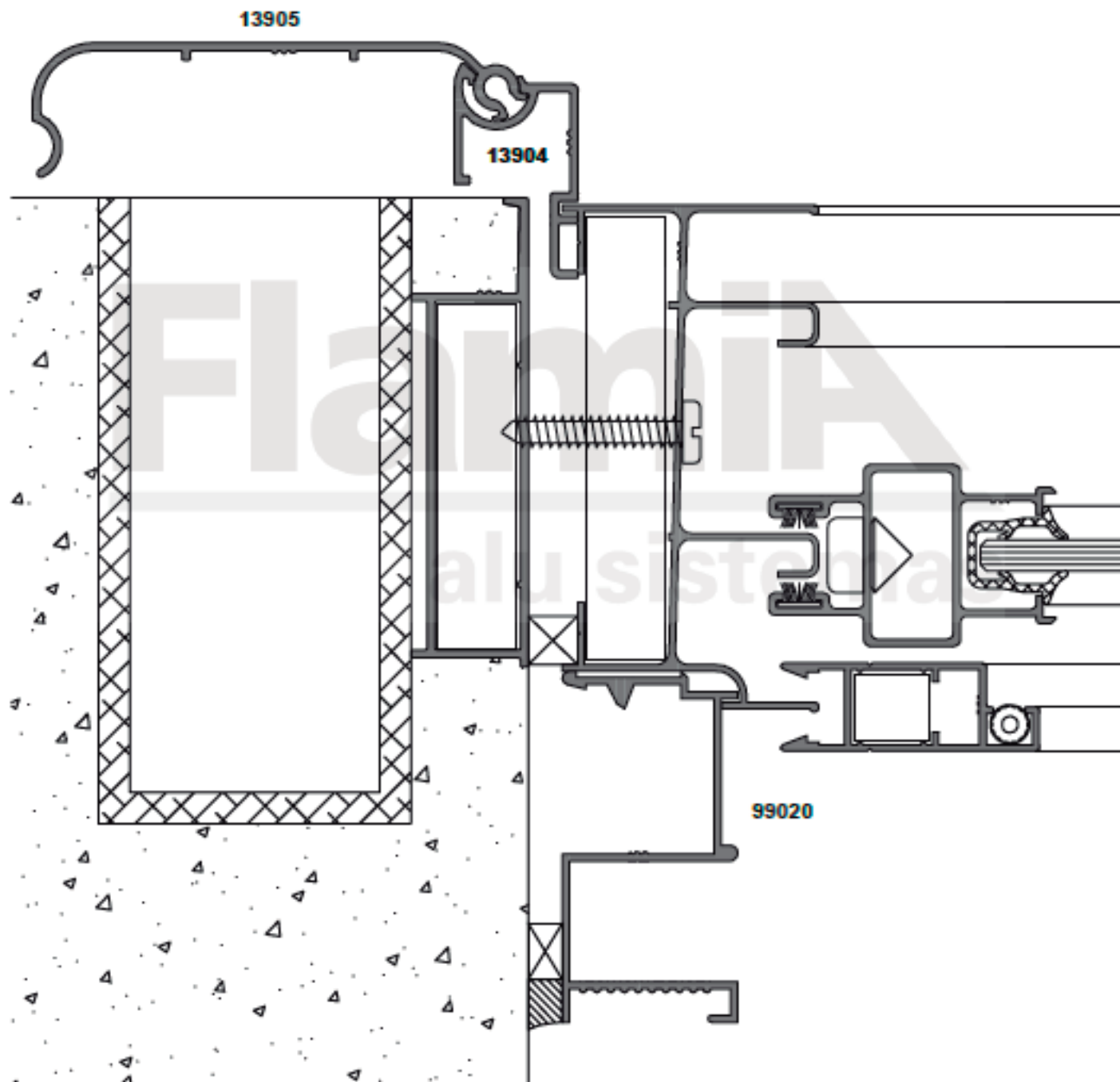
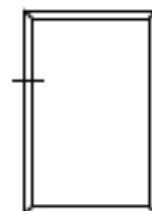

Corte horizontal guia para cortina barro.

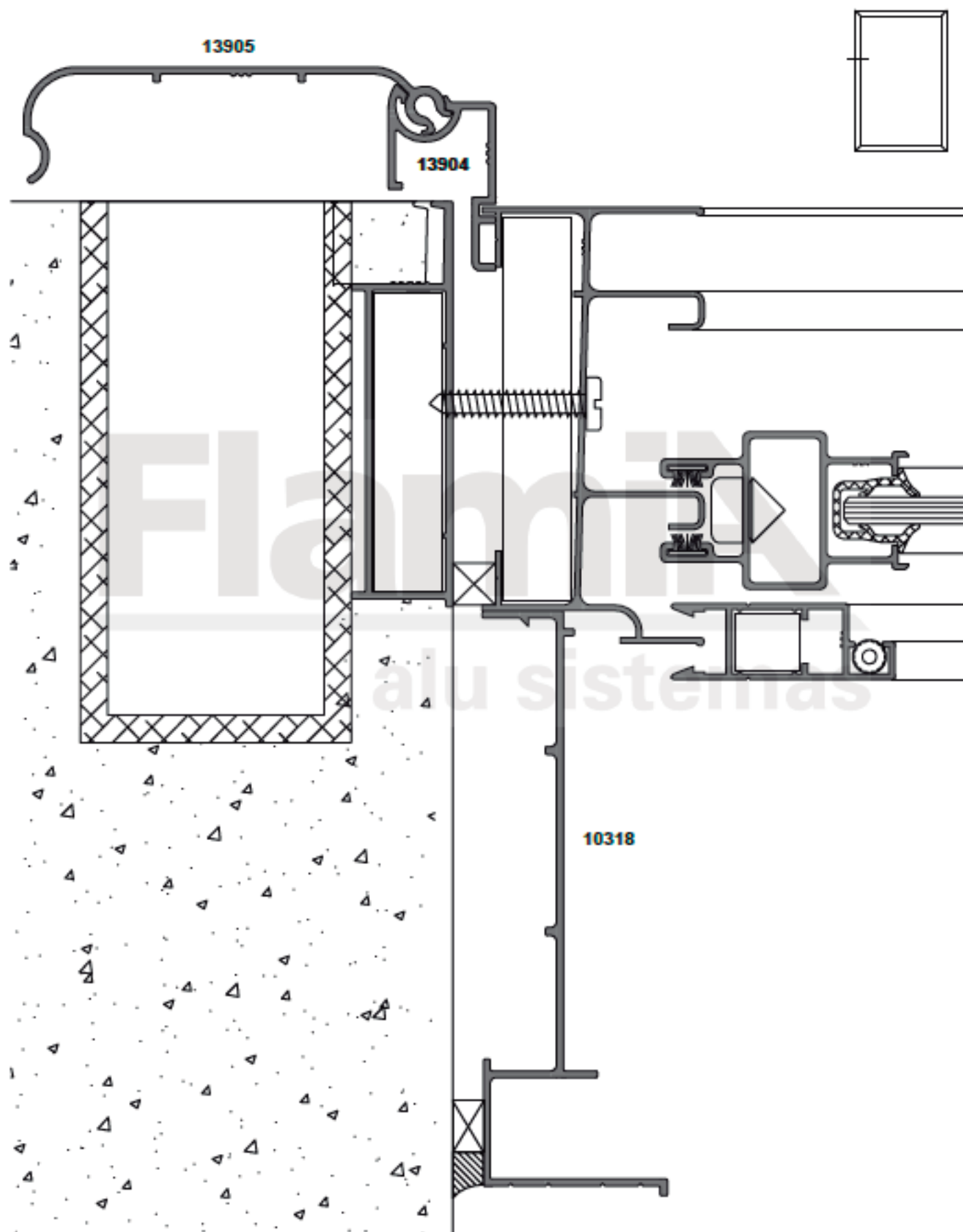

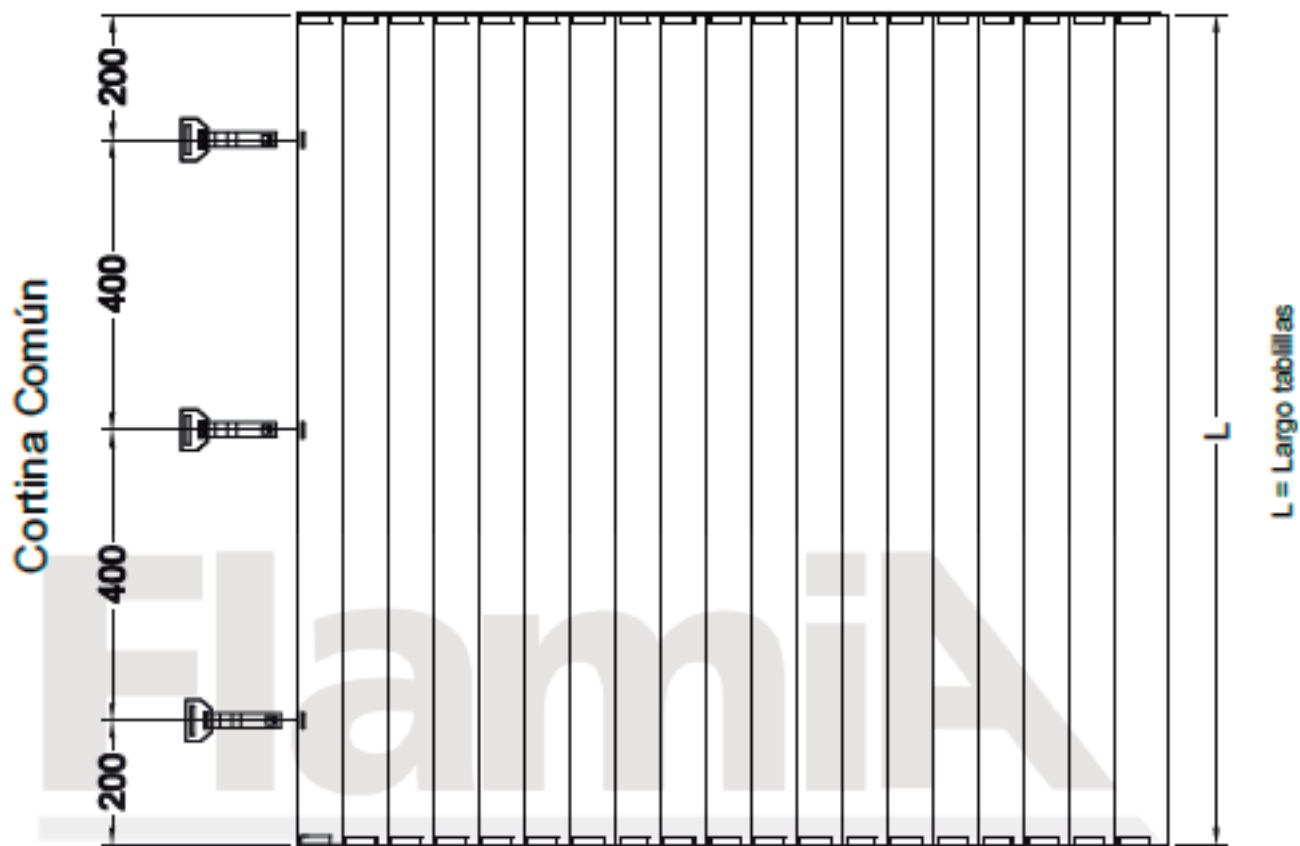

Cantidad de tablillas:

Altura carpintería (mm.) / 55 + 1 de 11777

Ejemplo:

Una ventana de 1200 mm. de alto sería:

$1200 / 55 = 21.8$ (22 tablillas) + 1 de 11777

Total: 22 Tablillas 12626 y 1 Tablilla 11777

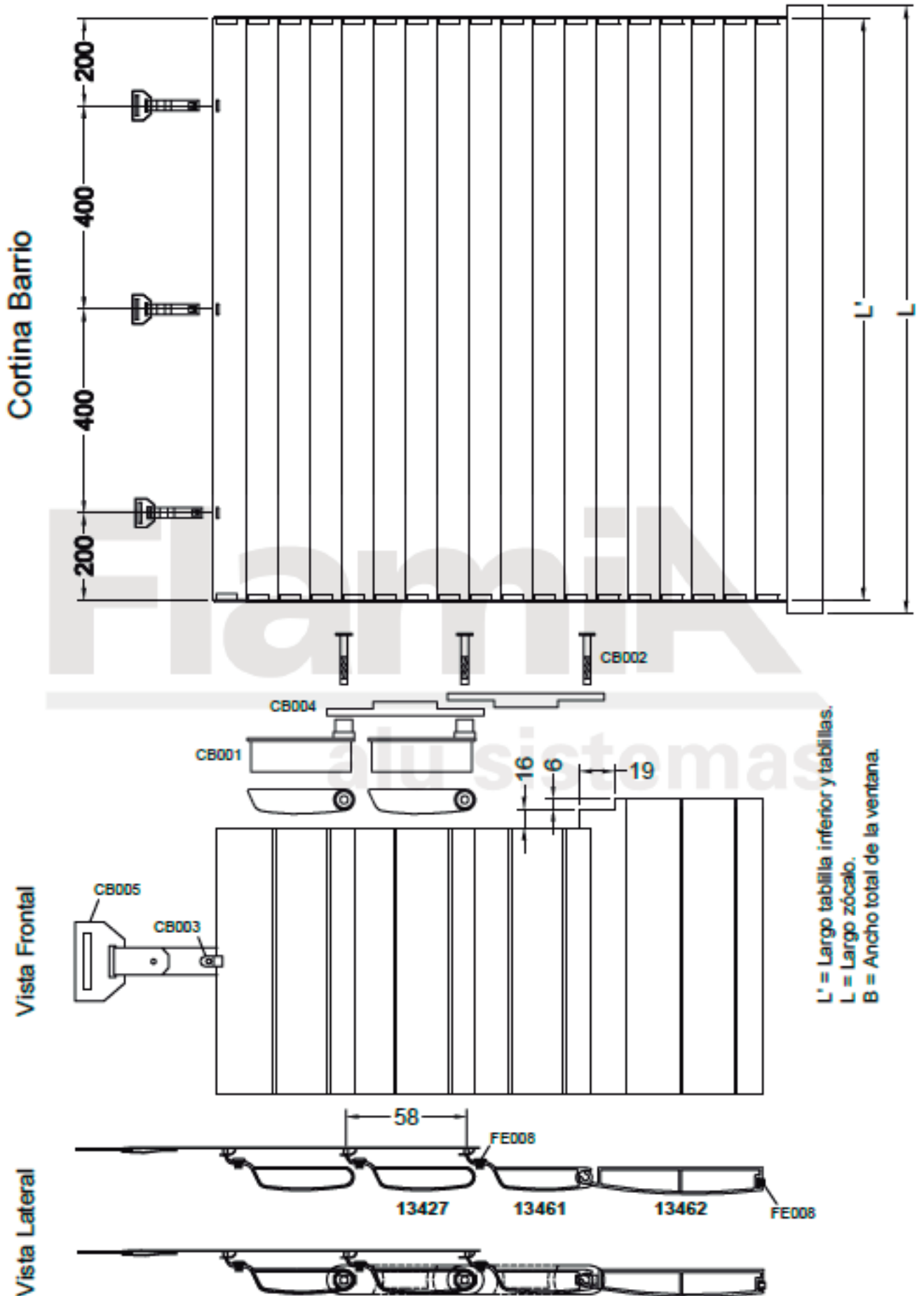

Cortina Común

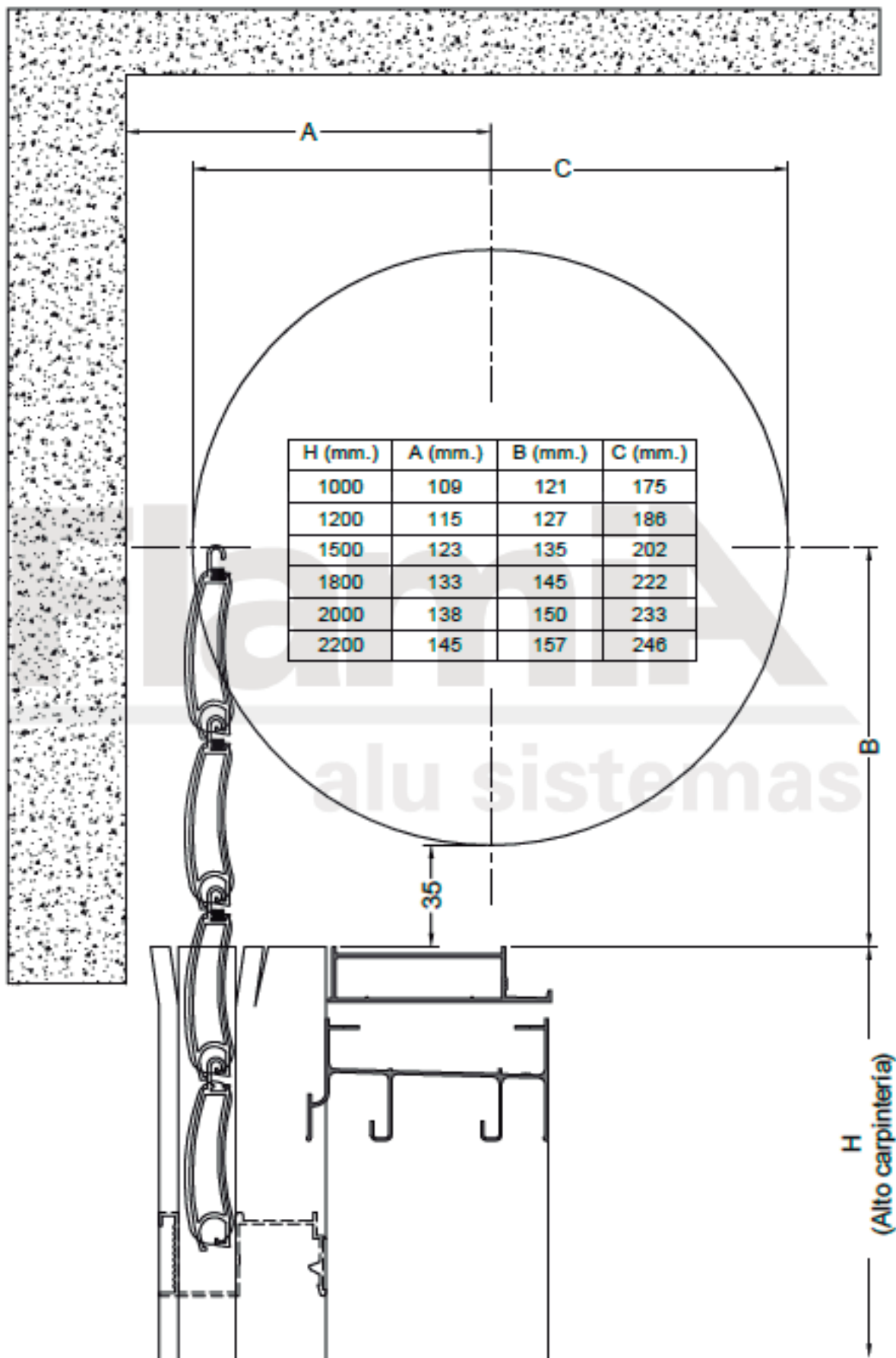

Cortina Barrio

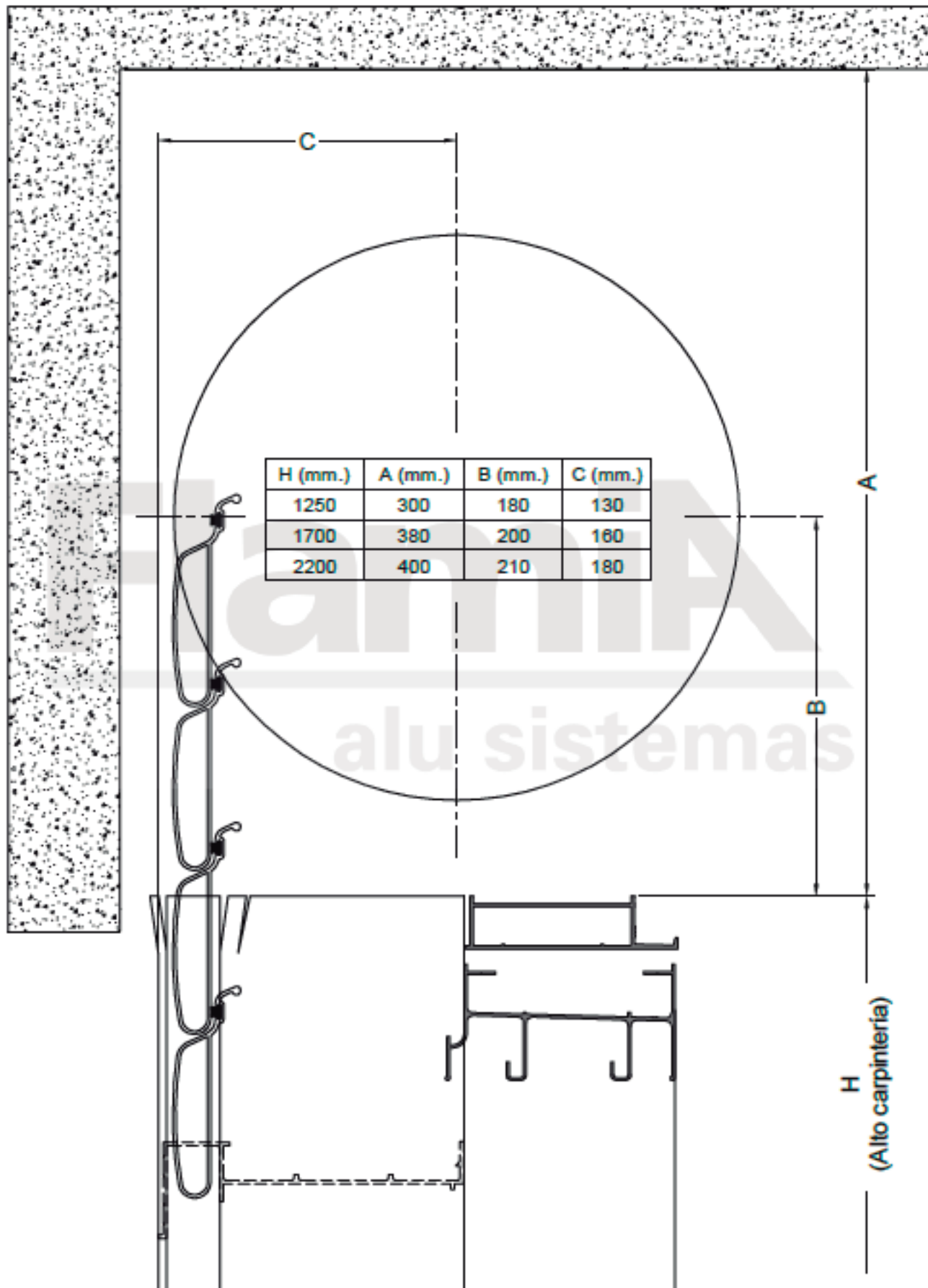

Cortina Barrio

NOTA: En ningún caso la última tablilla de cortina en posición abierta, debe sobrepasar la altura de la ventana
En caso de reemplazar una cortina existente verificar estas medidas.

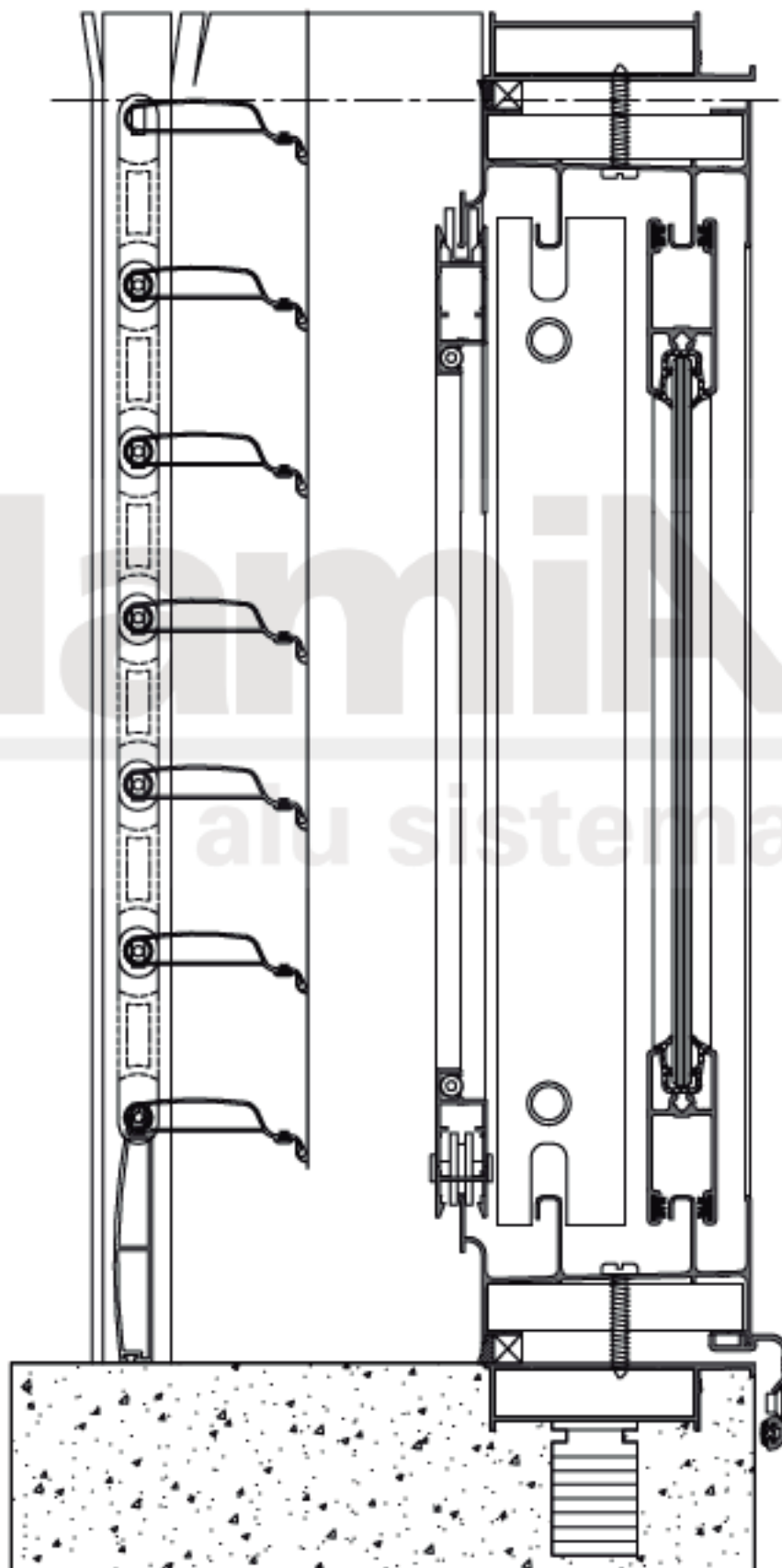

Escala 1:2

SISTEMAS DE CARPINTERIA

Standard

MECANIZADOS

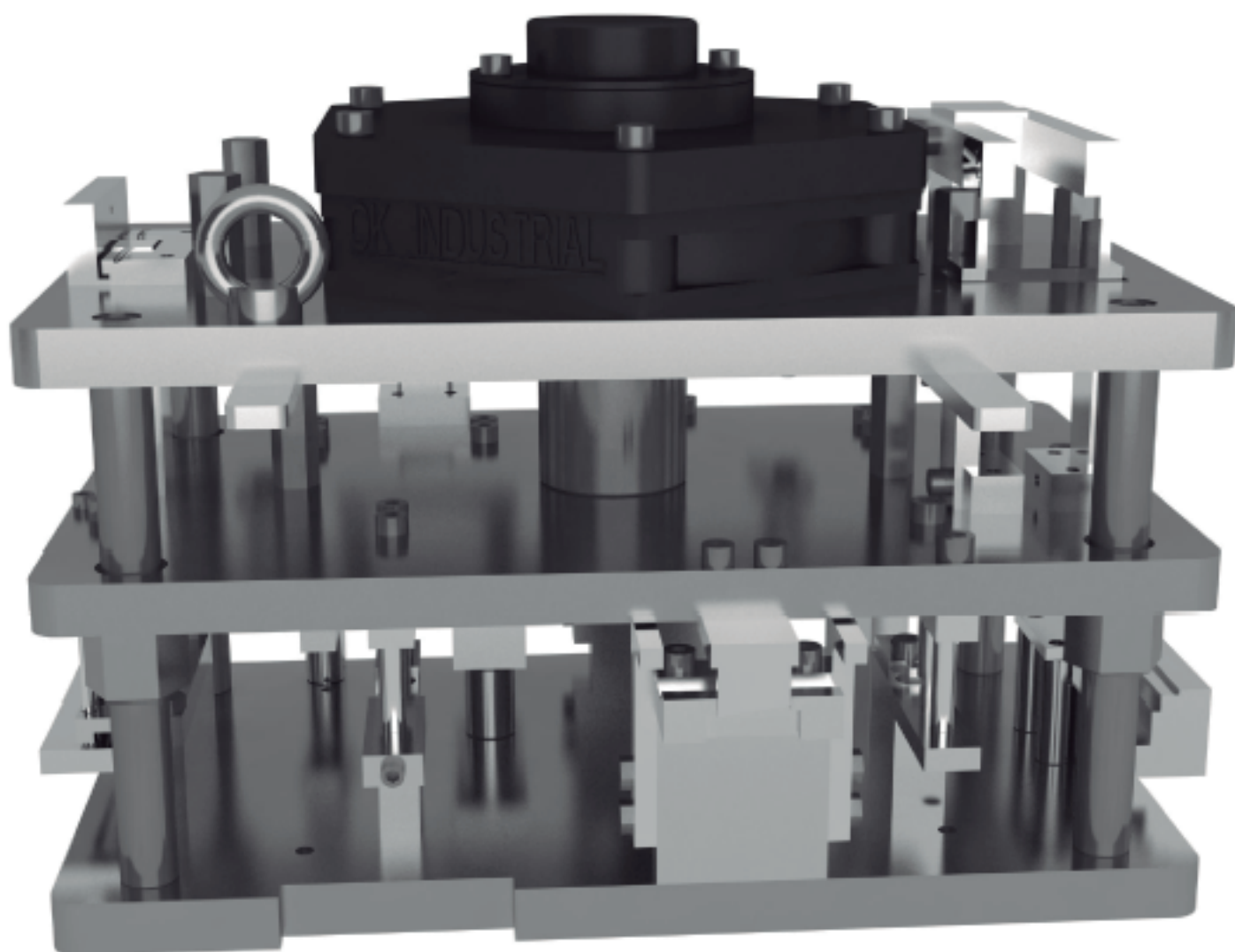

MECANIZADOS
Punzonadora Standard
Vista frontal

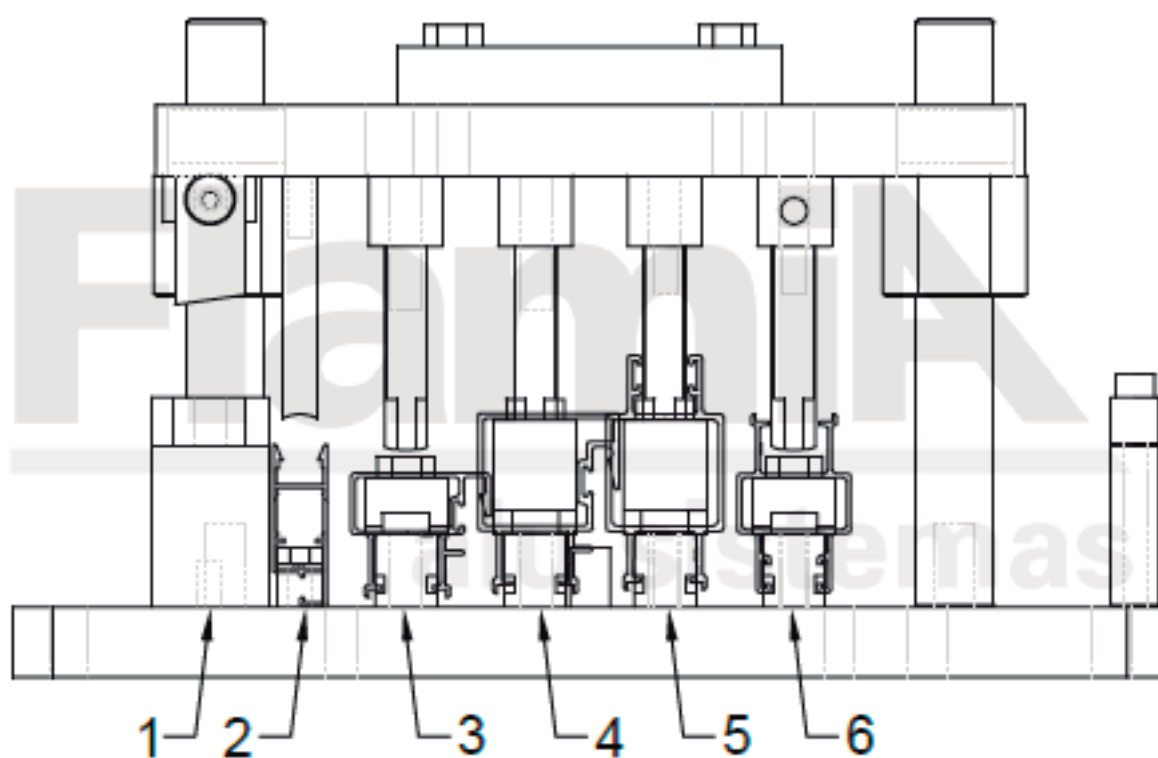

MECANIZADOS
Punzonadora Standard
Vista lateral

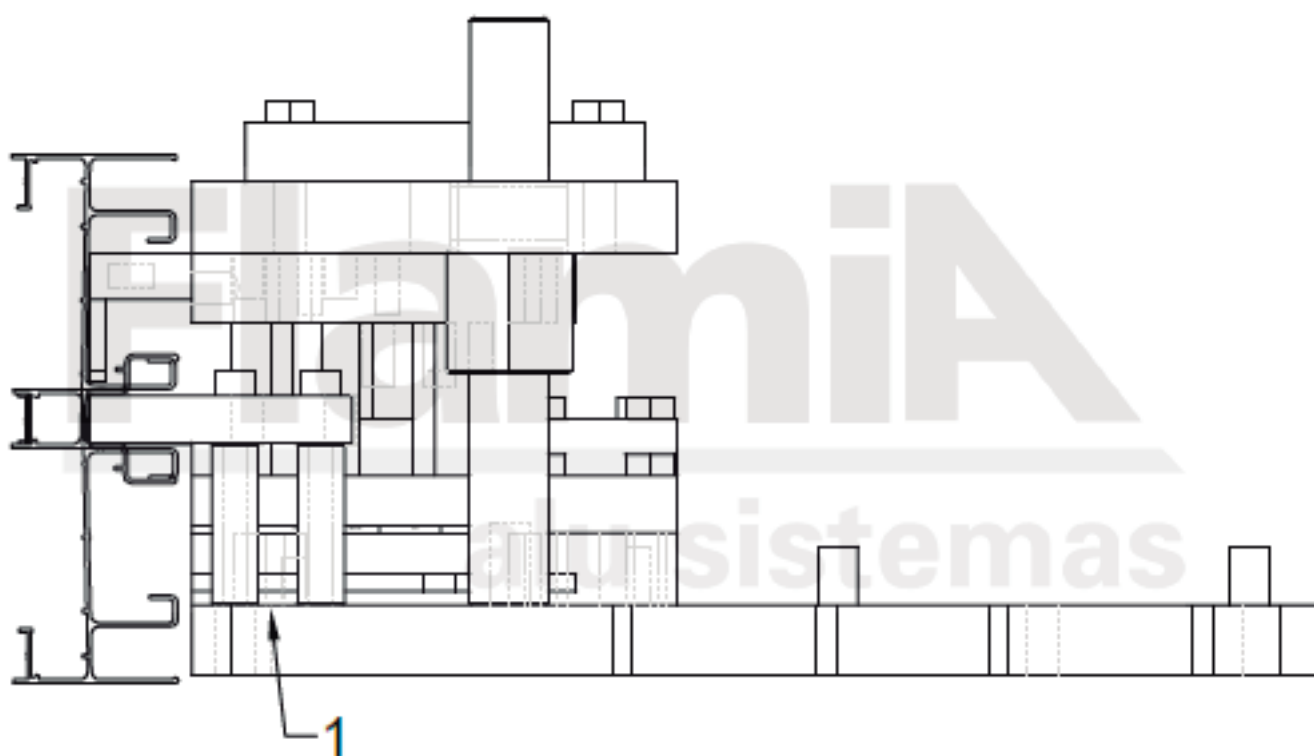

Mecanizado de perfiles con punzonadora manual modelo 3/8 Herrero

1. Perfil N° 17901, 99001, 99901 y 99691
Mecanizado para desagüe de marco

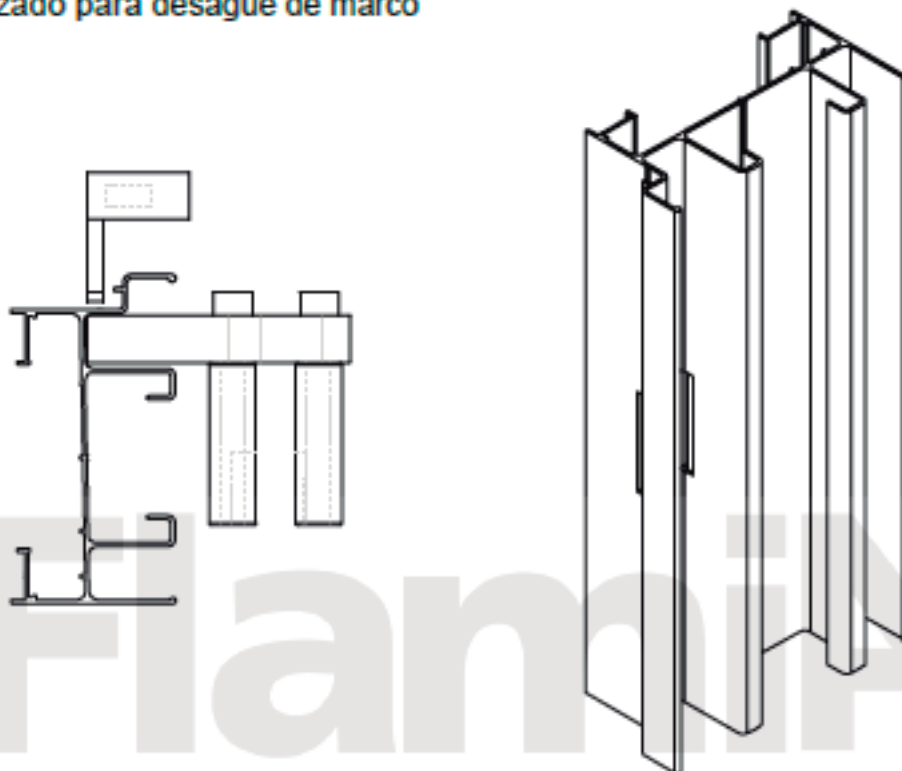

2. Perfil N° 12005
Mecanizado para rueda de mosquitero

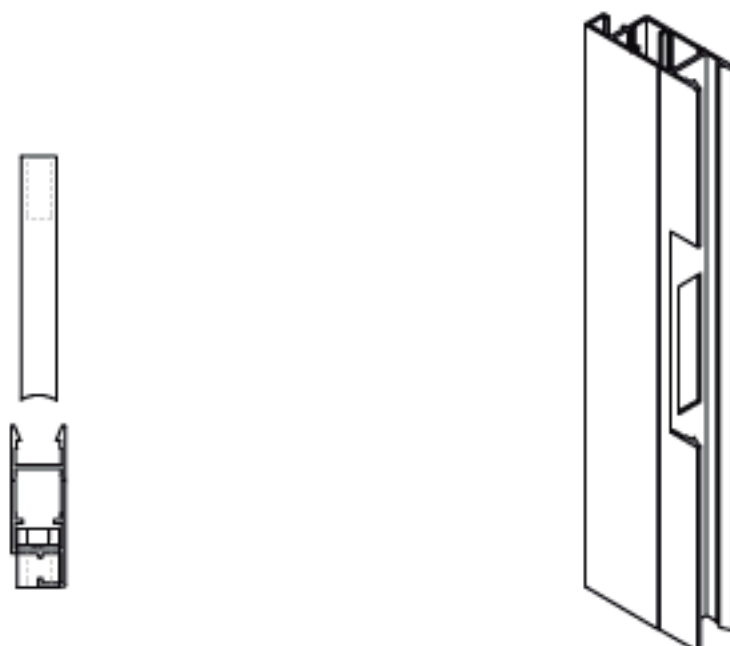

Mecanizado de perfiles con punzonadora manual modelo 3/8 Herrero

3. Perfil N° 12003 y 12004 Mecanizado ranura larga

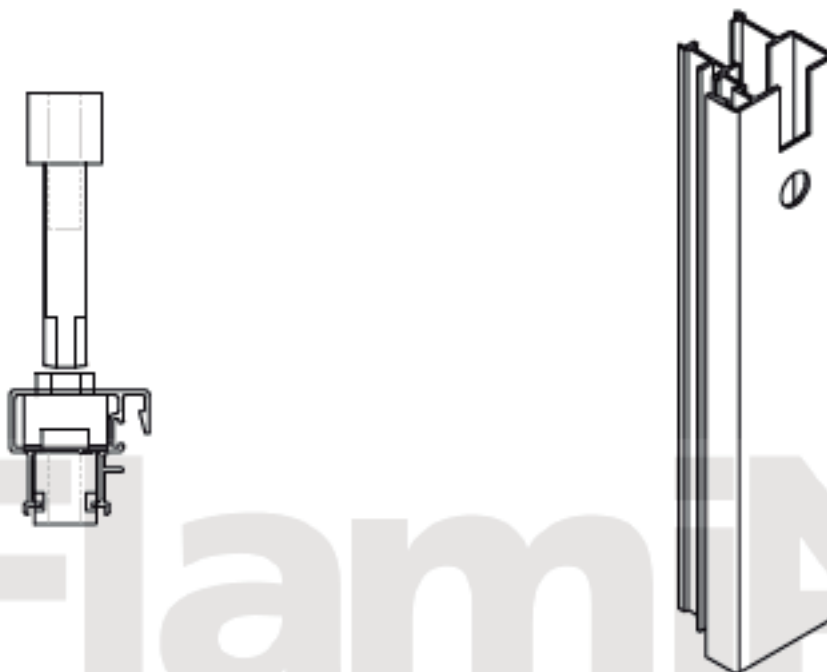

4. Perfil N° 99053 y 99054 Mecanizado ranura larga

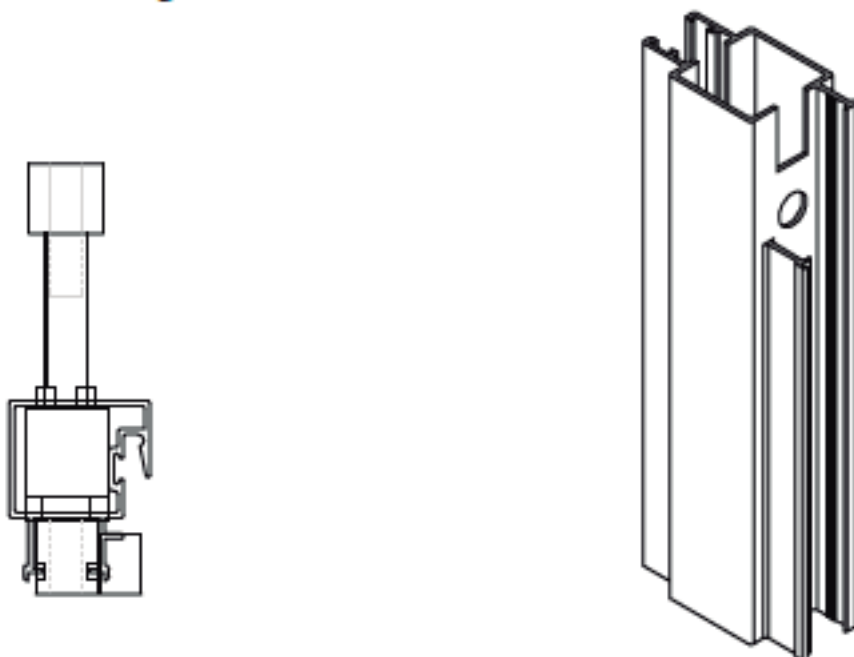

Flam
alu sistemas

Mecanizado de perfiles con punzonadora manual modelo 3/8 Herrero

5. Perfil N° 99053 y 99054

Mecanizado ranura corta

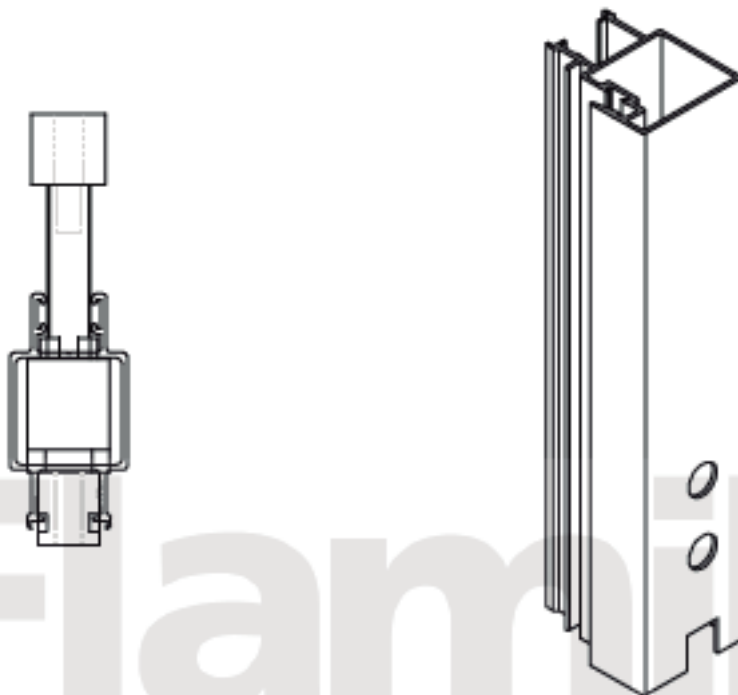

6. Perfil N° 12003 y 12004

Mecanizado ranura corta

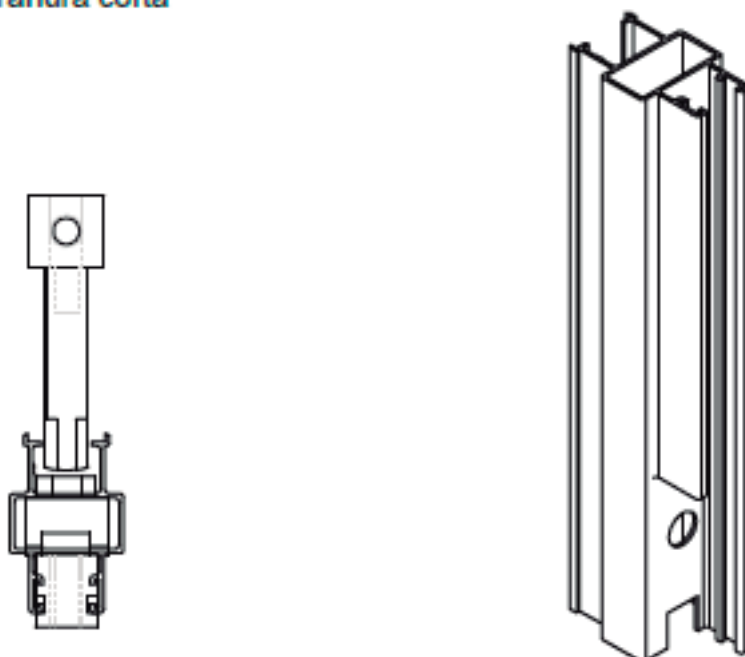

Flam
alu sistemas

Uso de escuadras

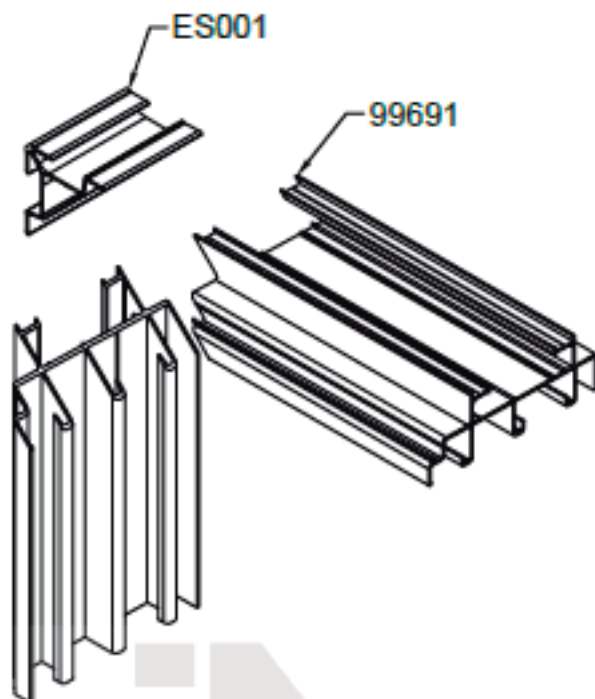
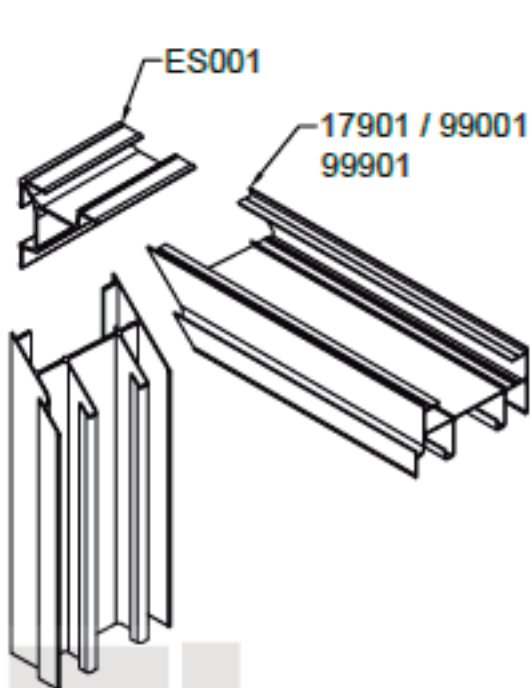

FlaminiA

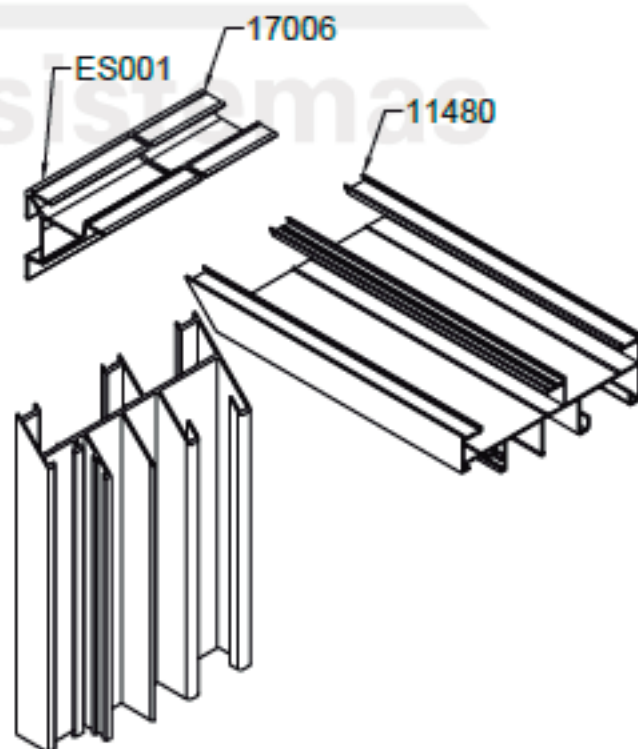
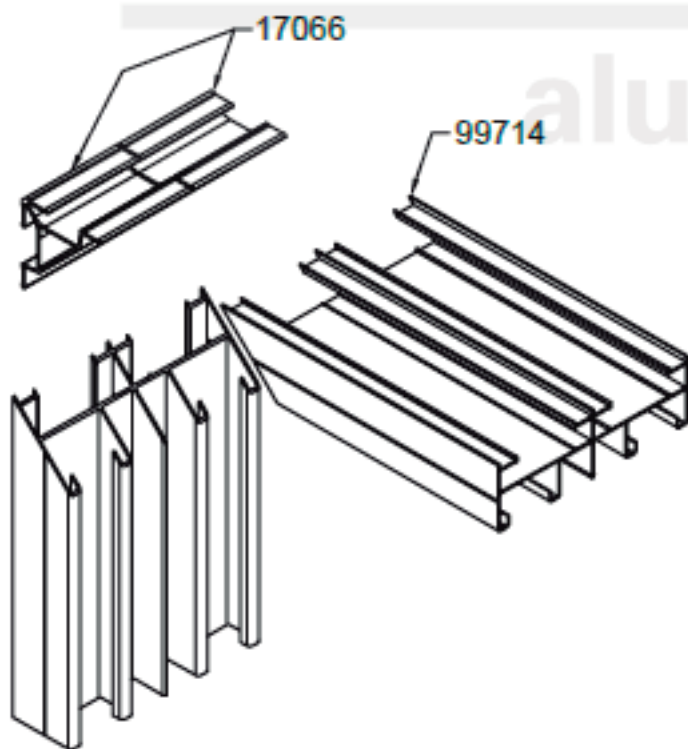

Uso de escuadras

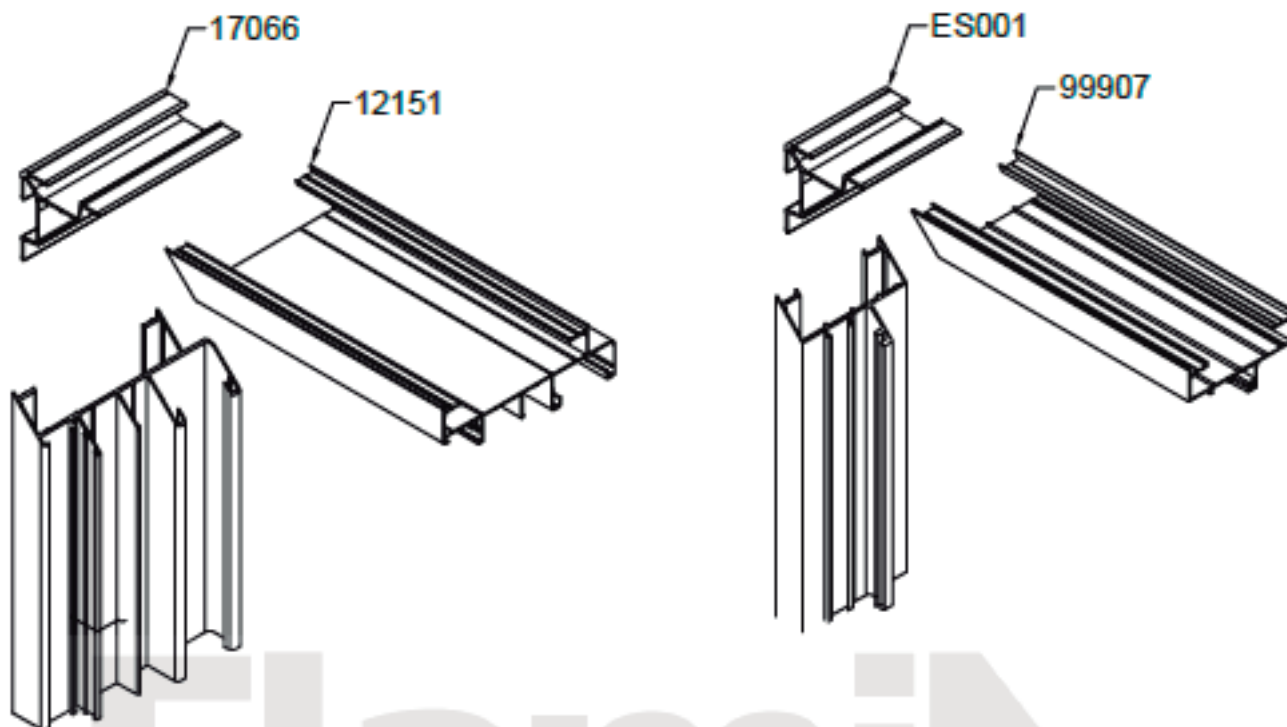

Uso de escuadras

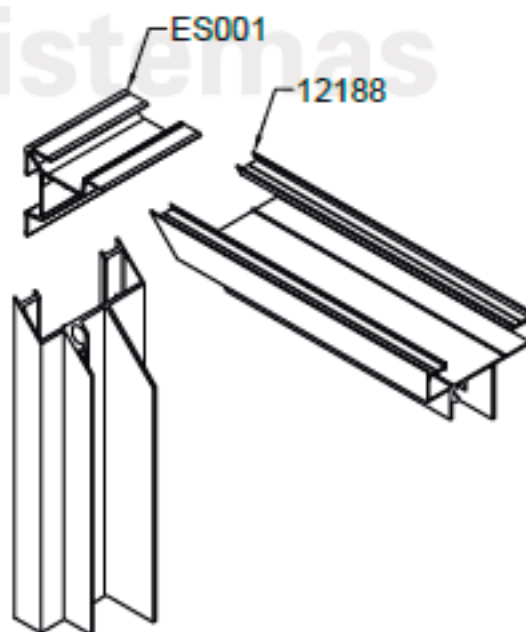
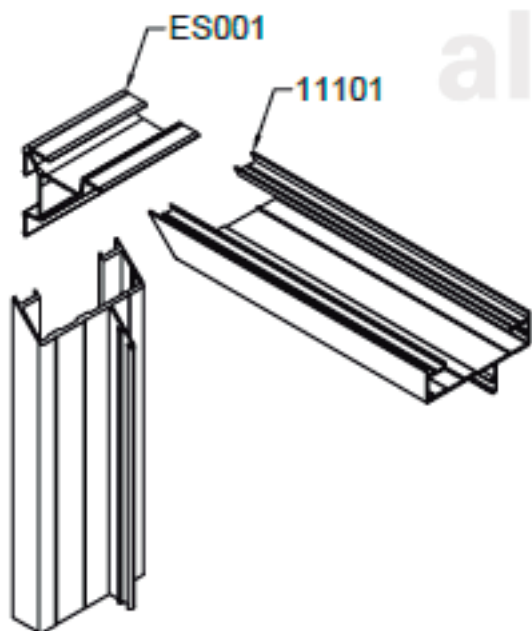
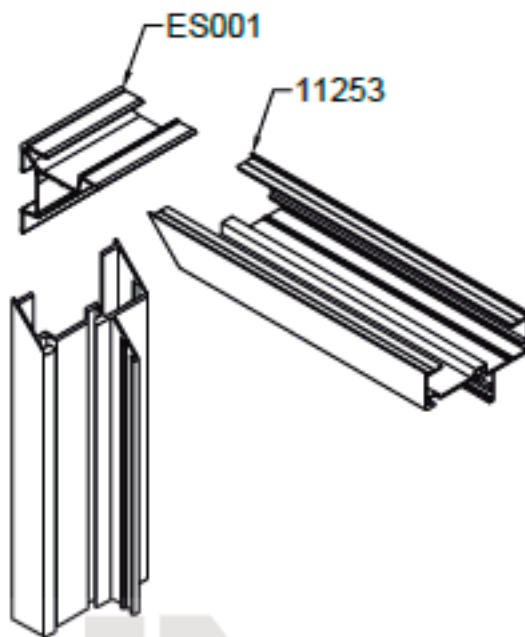
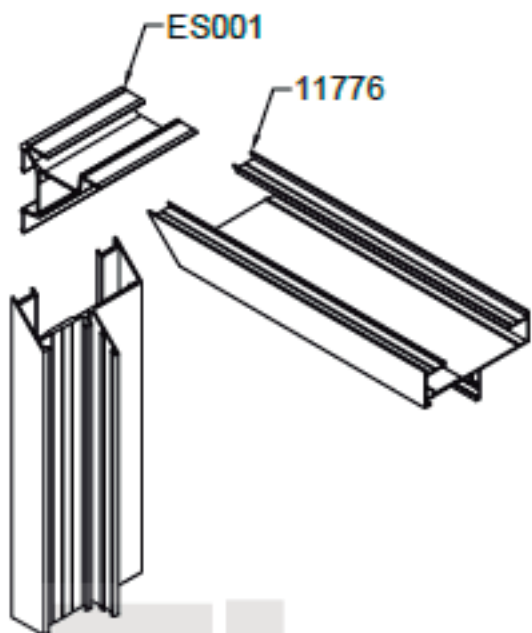

FlamIA
alu sistemas

Uso de escuadras

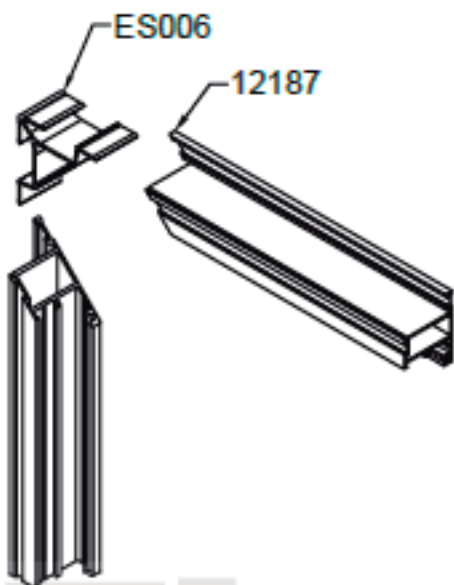

FlamiA
alu sistemas

Desagües para marco 2 guías

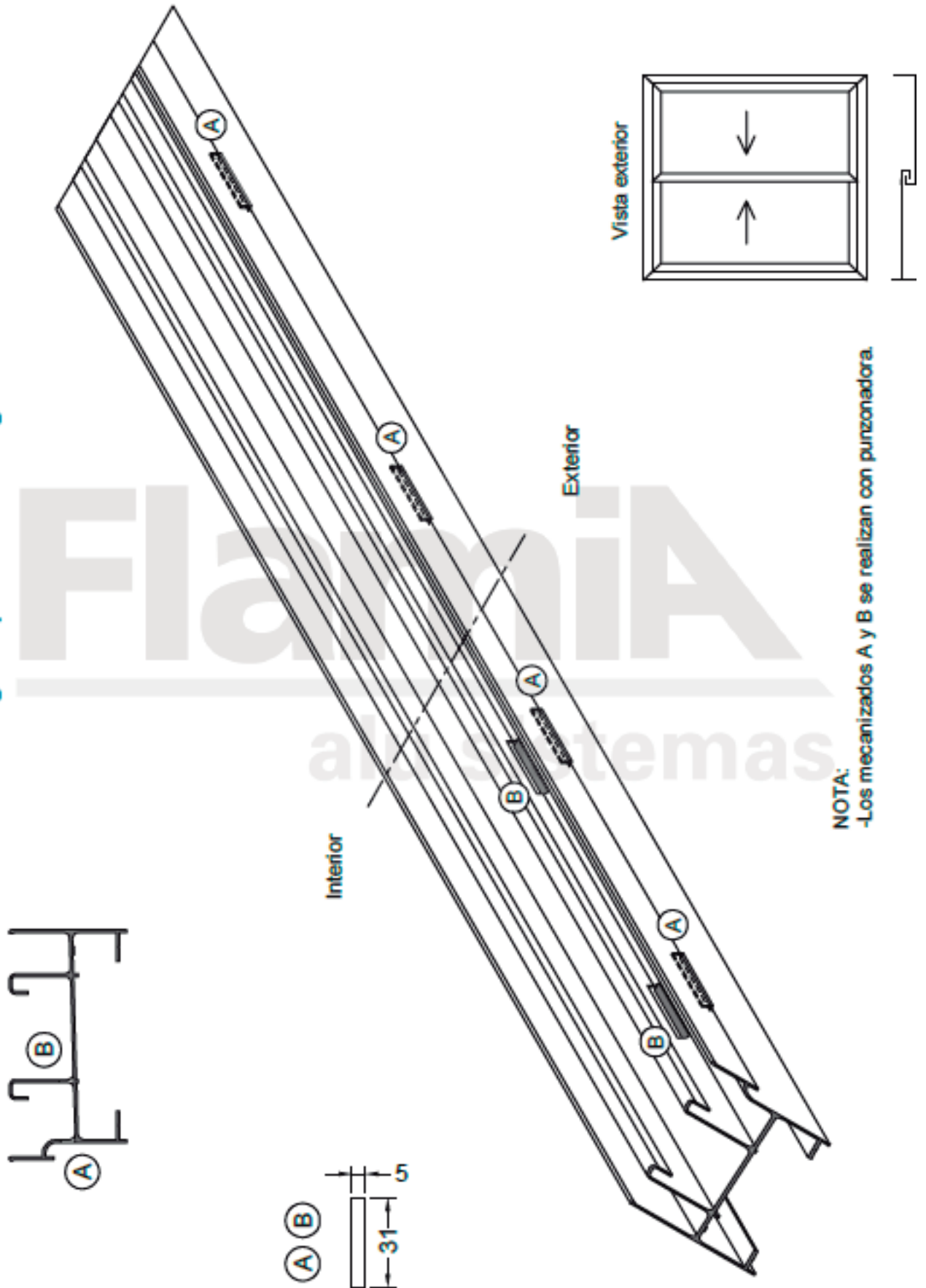

NOTA:
-Los mecanizados A y B se realizan con punzonadora.

Mecanizado de jamba y encuentro de hoja (12003 y 12004)

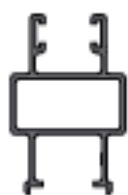

12003



12004

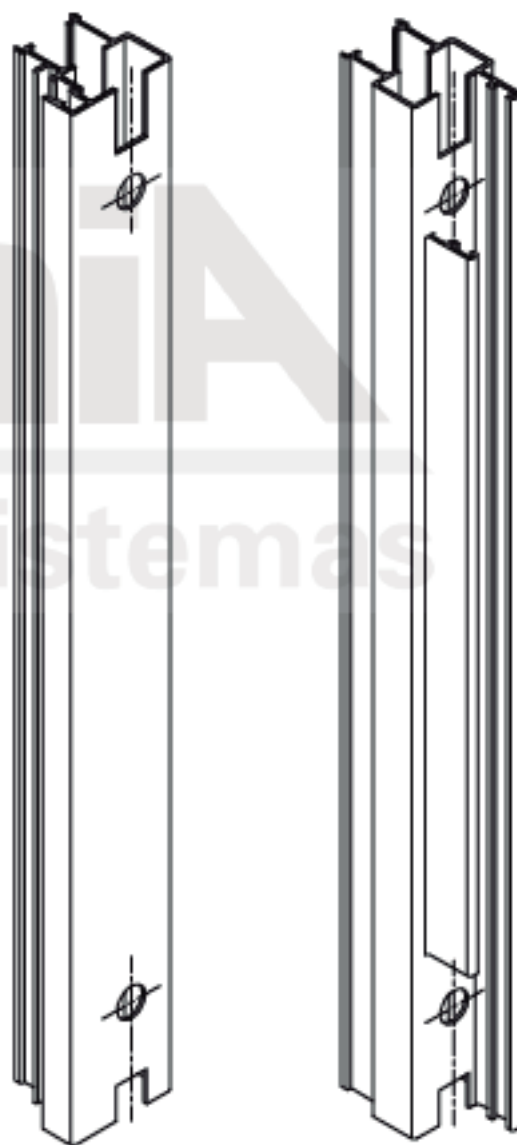
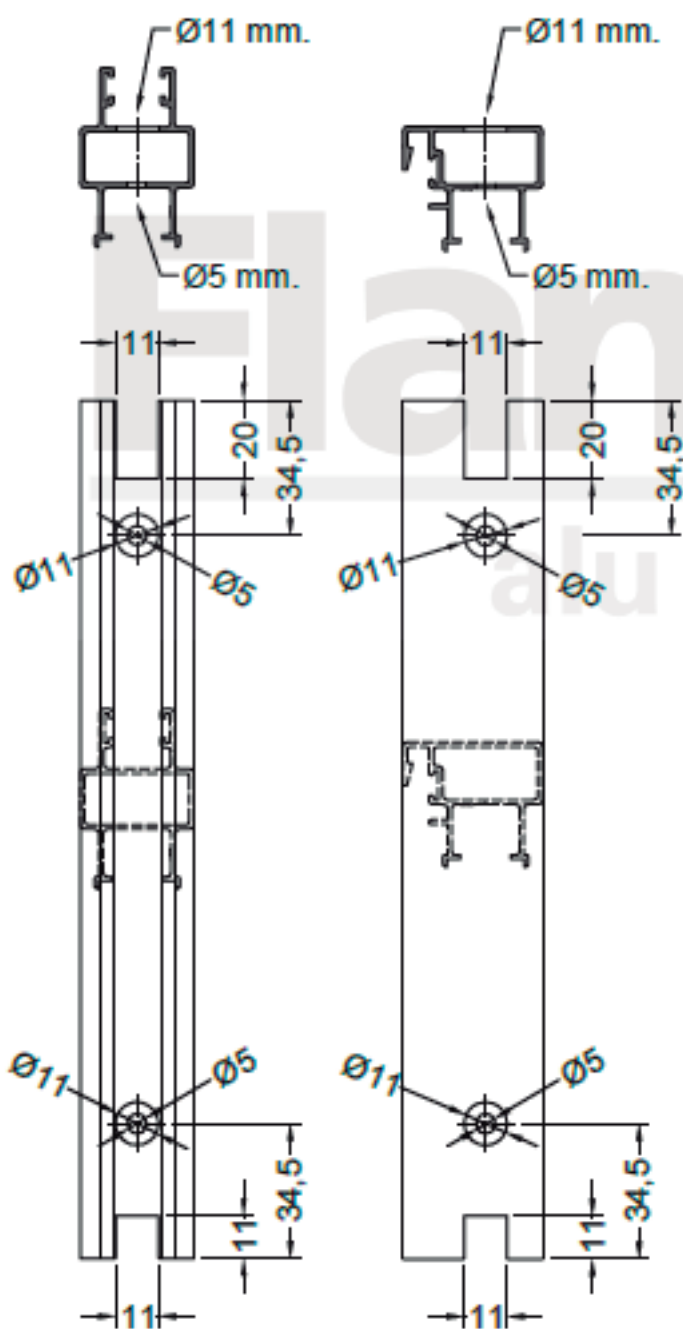
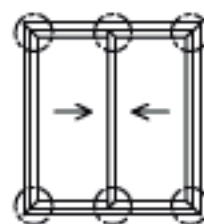

Realizado con punzonadora
(ver hoja 11.05 - 11.06)

Mecanizado de jamba y encuentro de hoja (99053 y 99054)



99053



99054

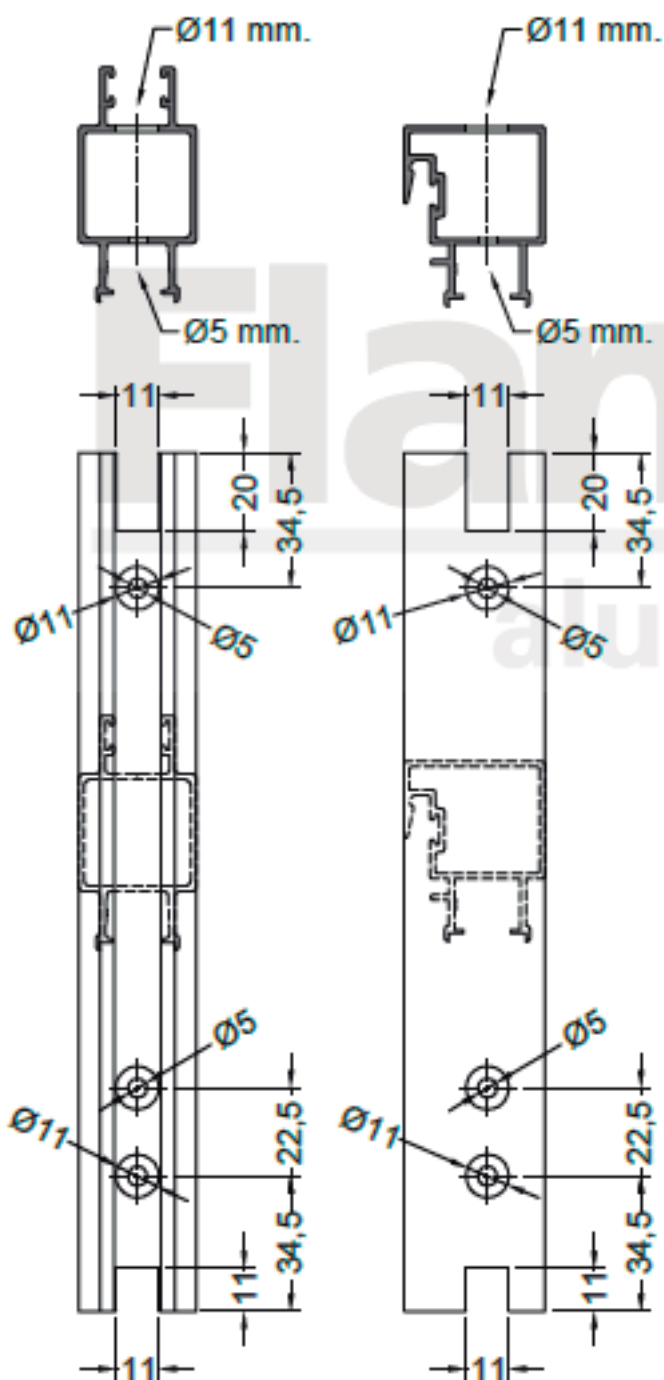
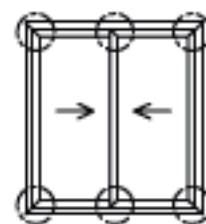

Realizado con punzonadora
(ver hoja 11.05 - 11.06)

Mecanizado para rueda de mosquitero



12005

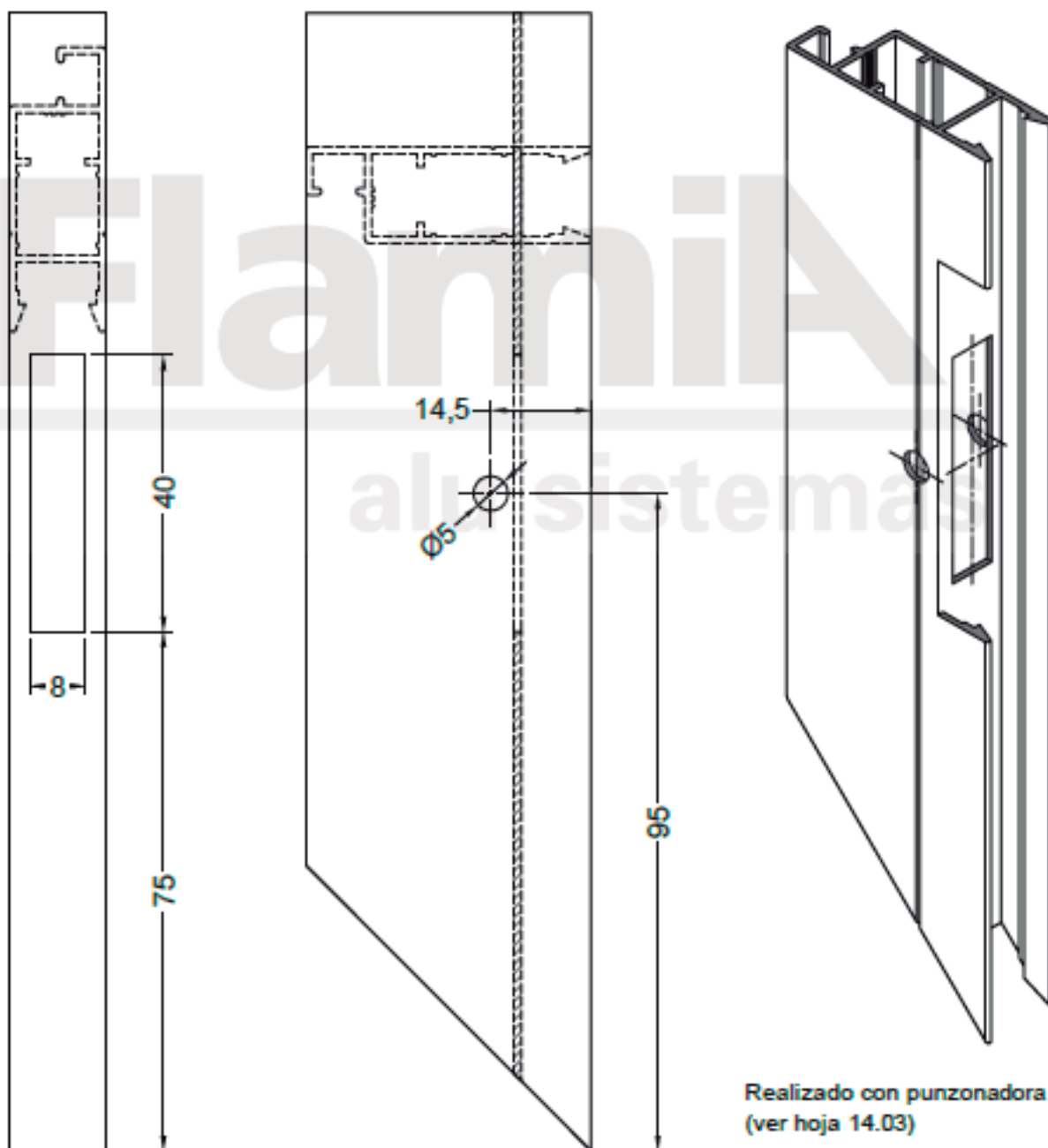
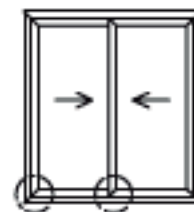

Realizado con punzonadora
(ver hoja 14.03)

Mecanizado para desagüe de paño fijo y ventana de abrir



10329 / 99907

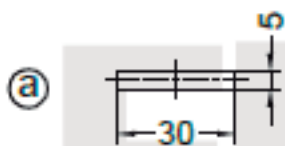
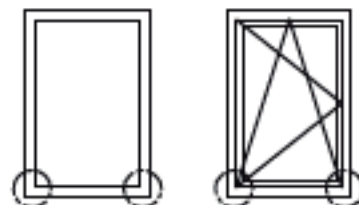

Realizado con copiadora

NOTA: La separación máxima entre mecanizados no debe ser superior a 500 mm.

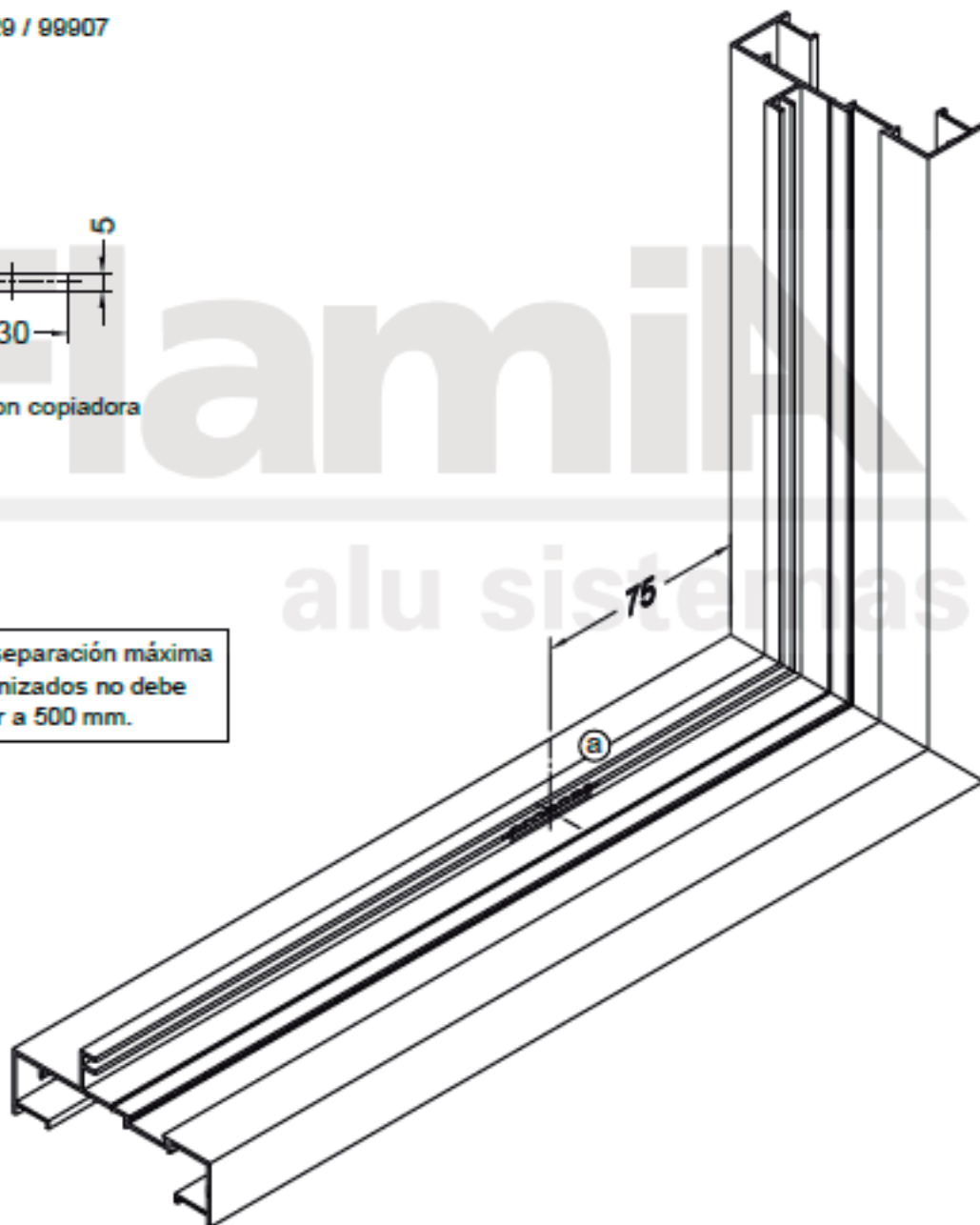

Mecanizado para desagüe de travesaño

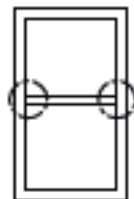
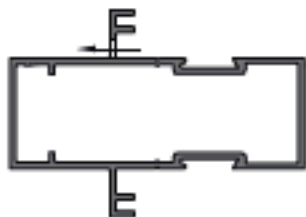

10328 / 99904

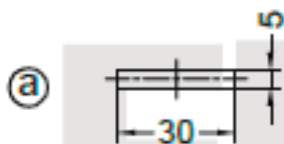

Realizado con copiadora

NOTA: La separación máxima entre mecanizados no debe ser superior a 500 mm.

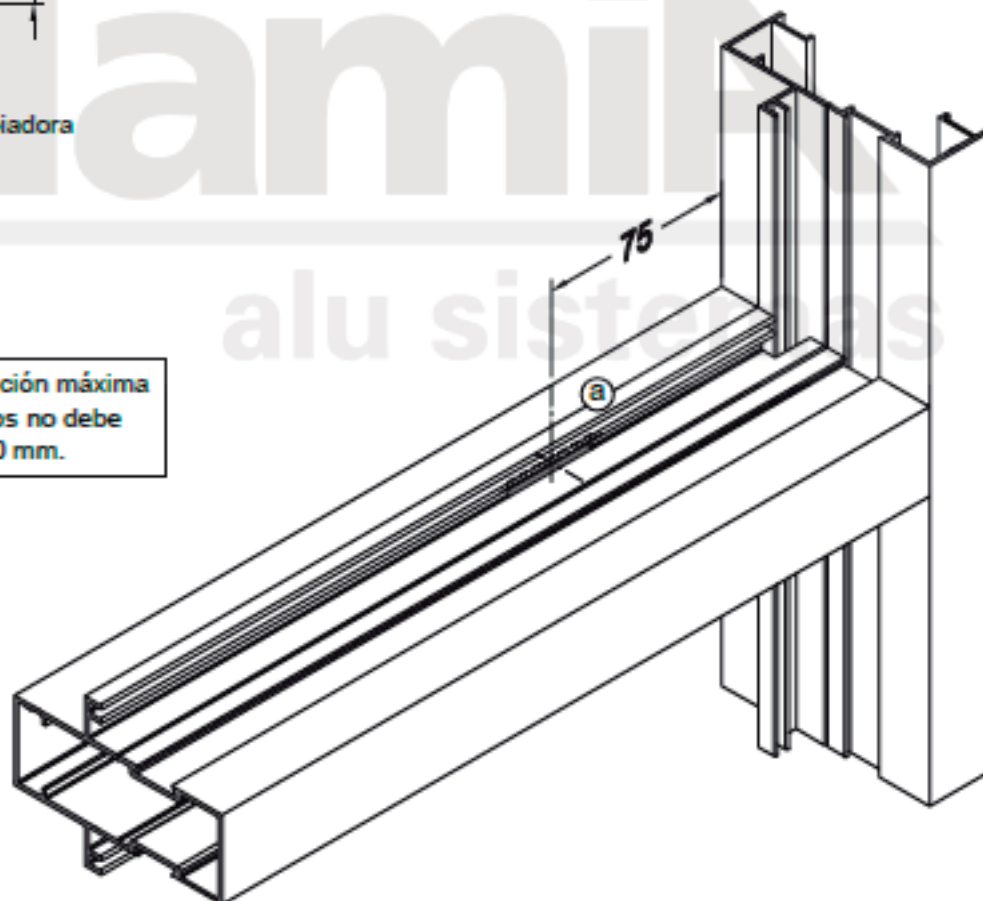

Mecanizado de travesaño

10328 / 99904

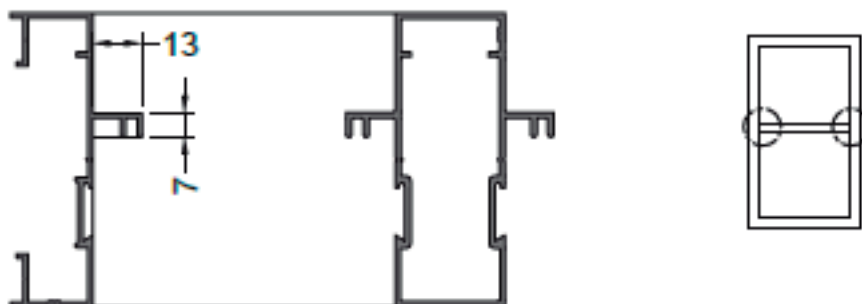

Realizado con copiadora o con retestadora mediante uso de fresa provista por OK Industrial

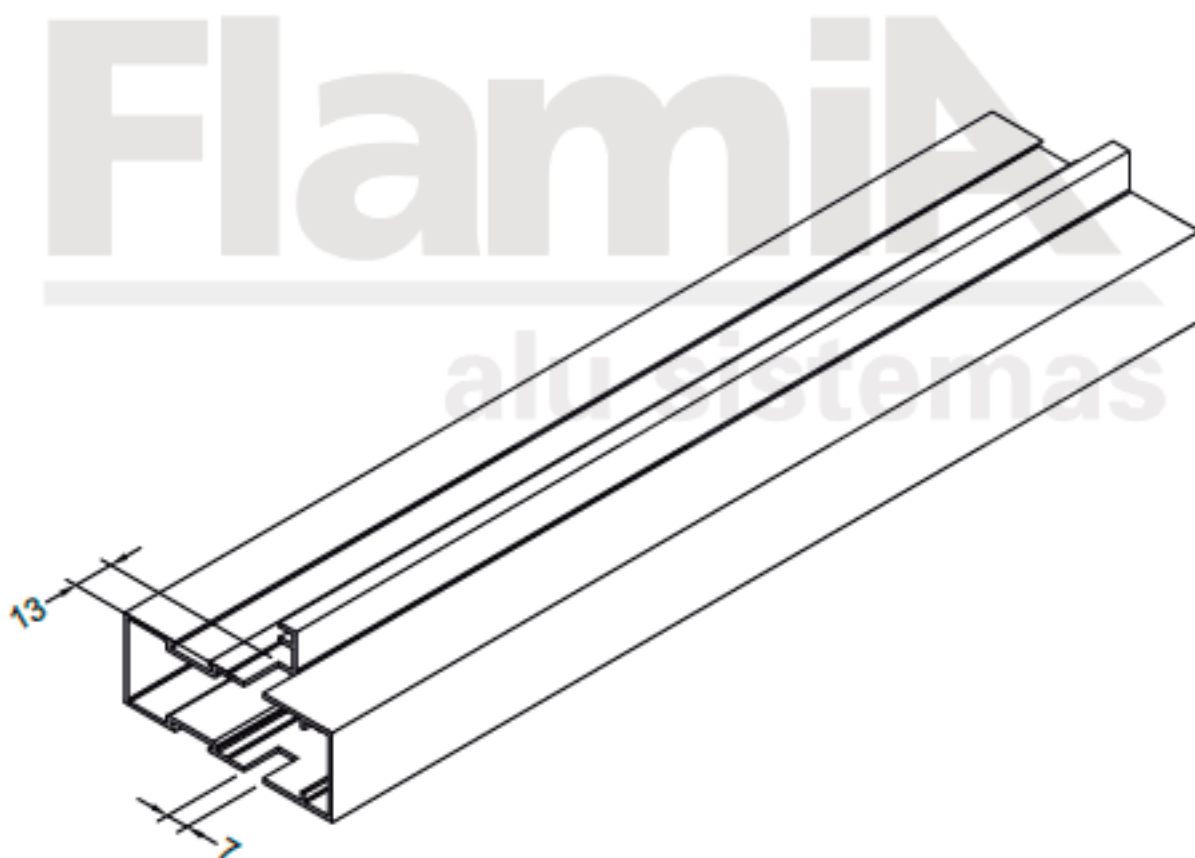

Mecanizado para zocalo y cabezal de puerta (perfil 14030 y 11577)

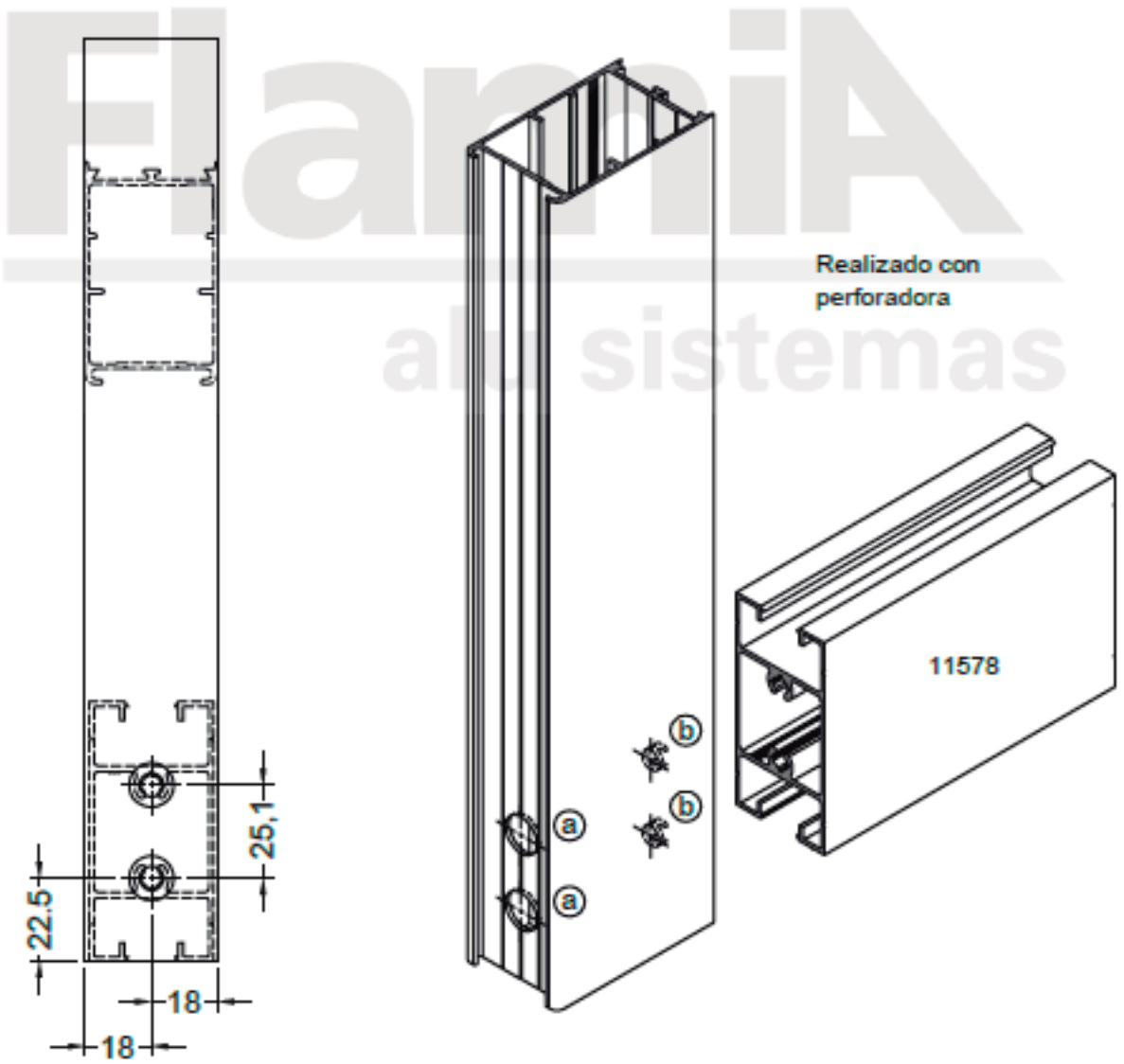
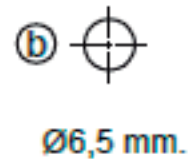
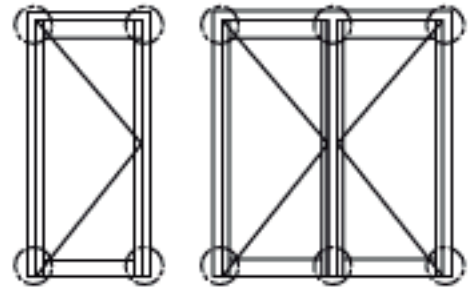
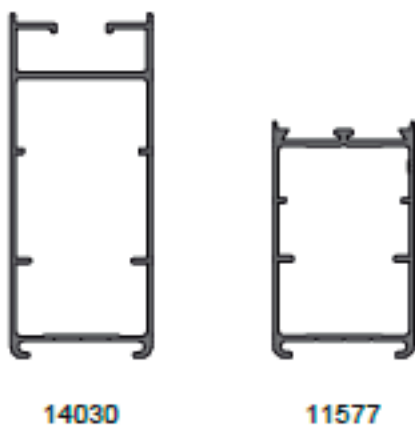

Mecanizado para zocalo y cabezal de puerta (perfil 11252)



11252

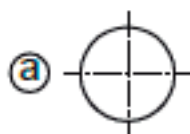
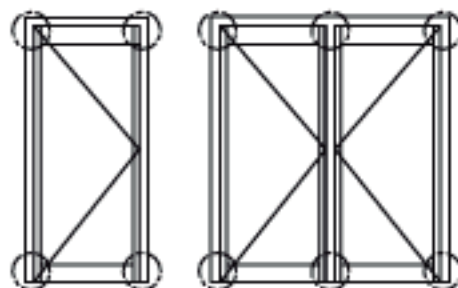

Ø12 mm.

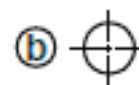

Ø6,5 mm.

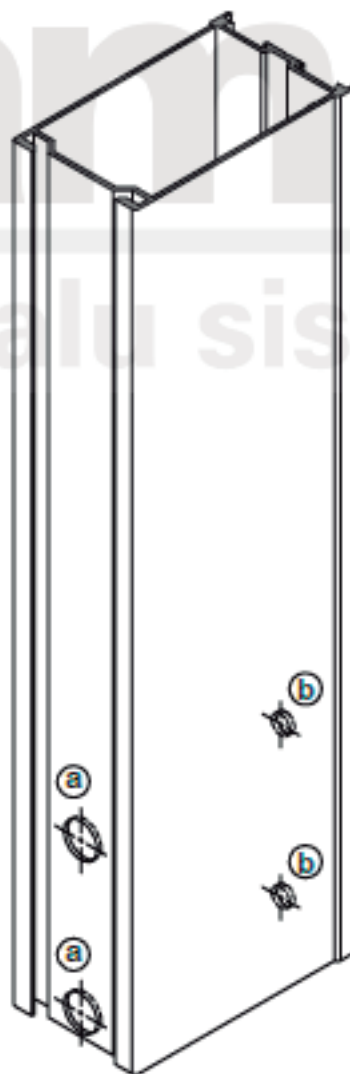
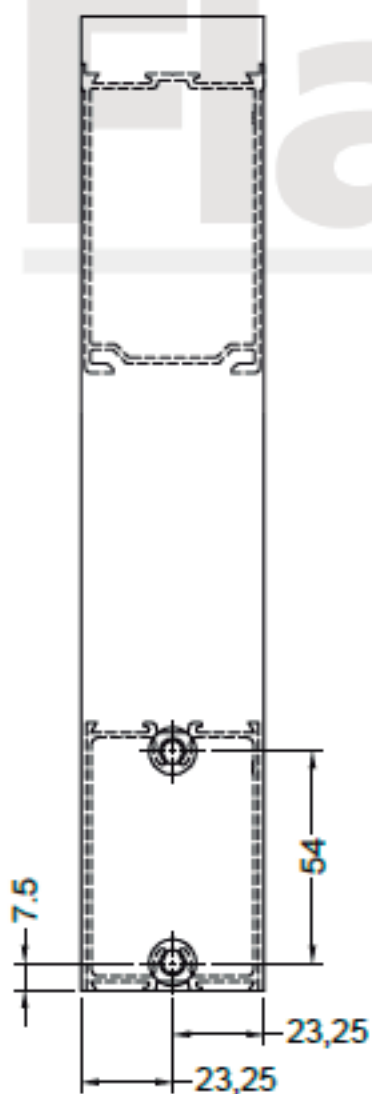

Realizado con perforadora

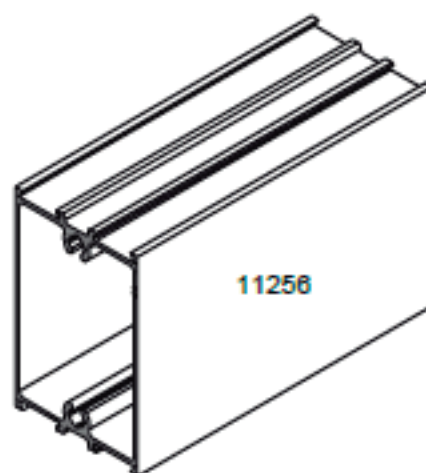

11256

Mecanizado para cerradura de puerta (CE001)

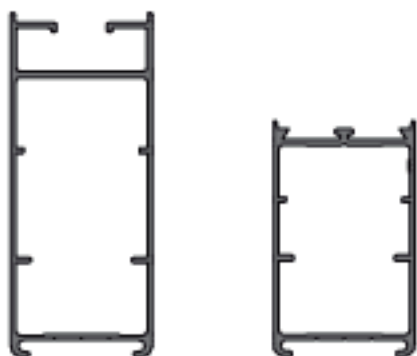

14030

11577

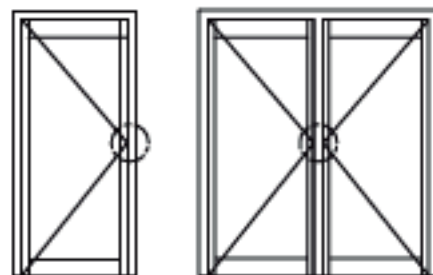

Realizado con copiadora

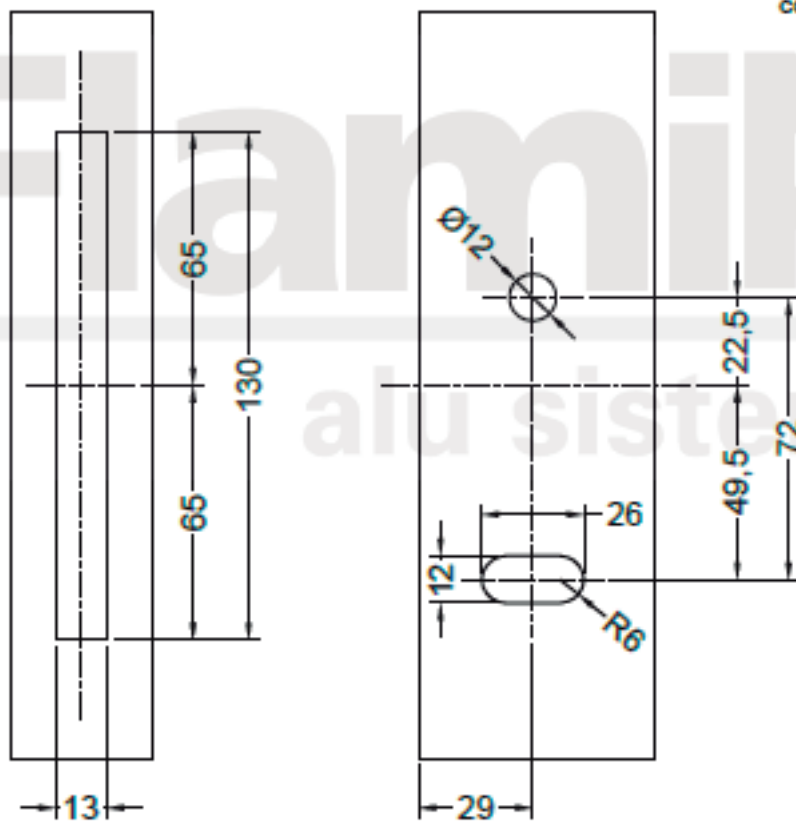

Este mecanizado es válido solamente para la cerradura CE001

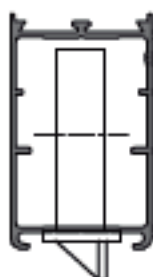

Mecanizado para cerradura de puerta (CE002)

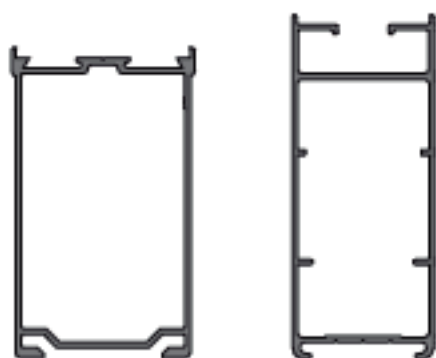

11252

14030

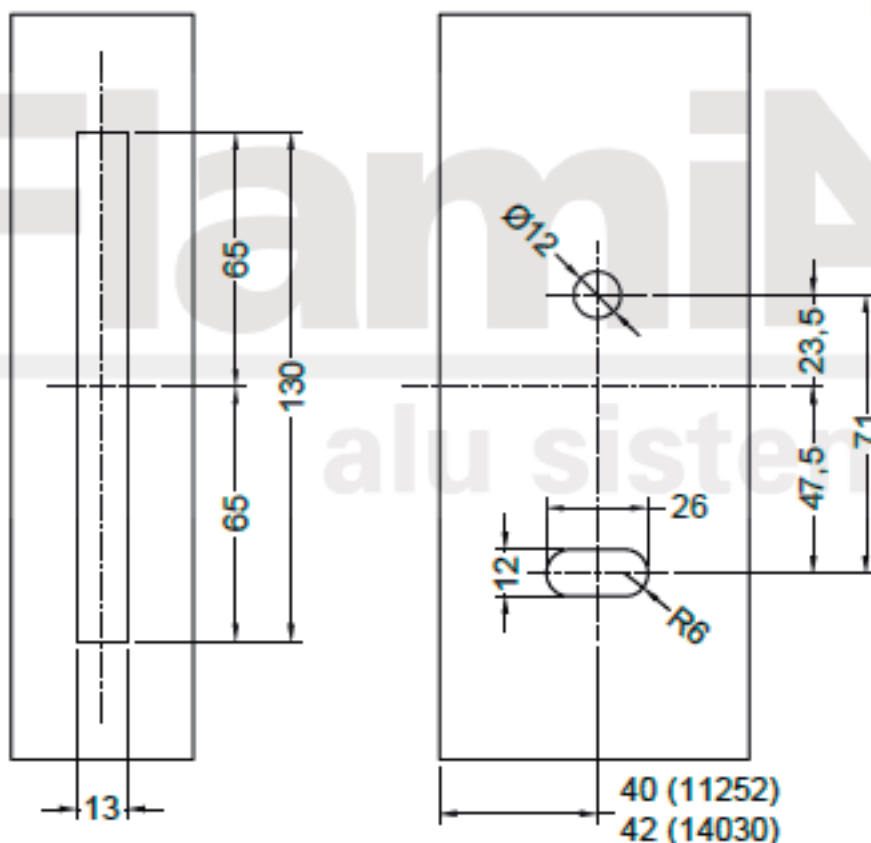
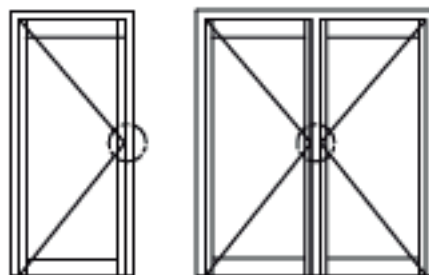

Realizado con copiadora

Este mecanizado es válido solamente para la cerradura CE002

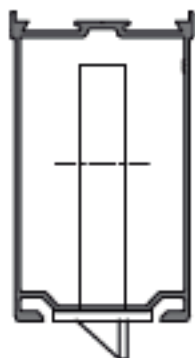

Mecanizado para cerradura de puerta (CE003)

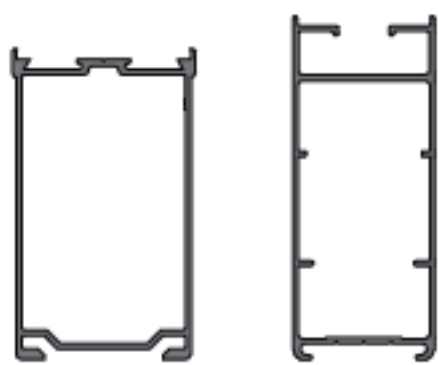

11252

14030

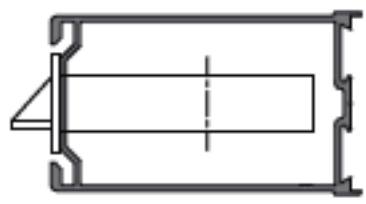
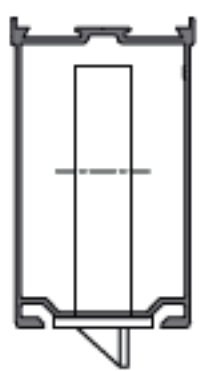
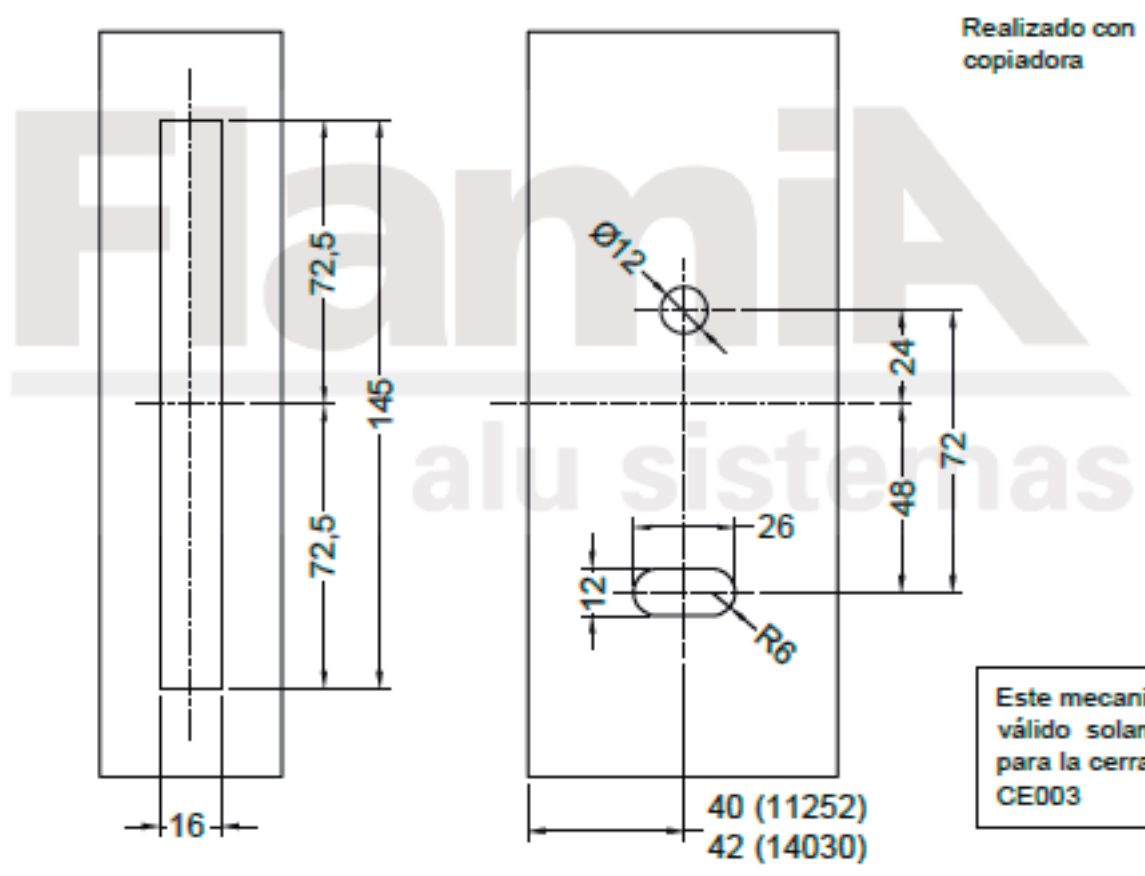
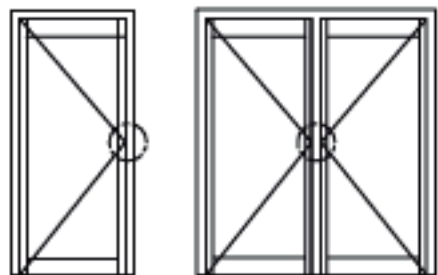

SISTEMAS DE CARPINTERIA

Standard

ACRISTALAMIENTO



RECOMENDACIONES PARA EL TAQUEADO DE VIDRIOS

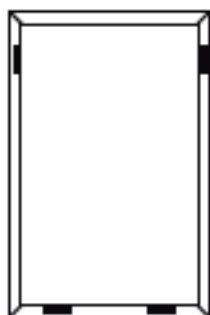

Paño fijo

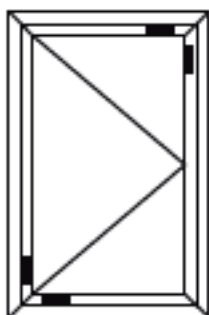

Batiente 1 hoja

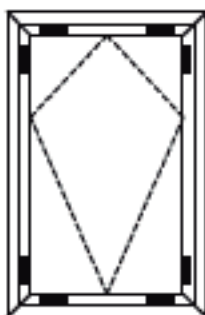

Desplazable

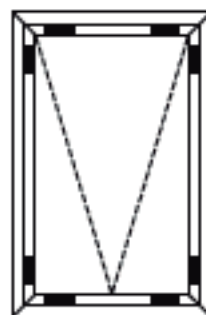

Ventiluz

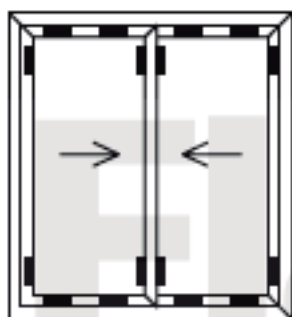

Corrediza 2 hojas

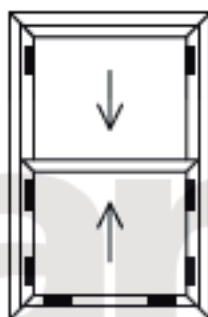

Guillotina

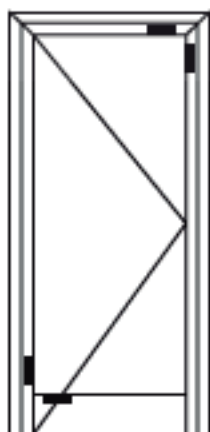

Puerta 1 hoja

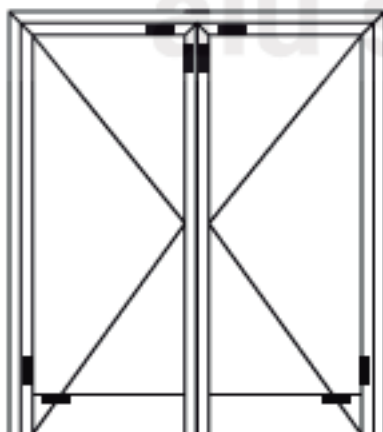

Puerta 2 hojas

SISTEMAS DE CARPINTERIA

Standard

DIMENSIONES

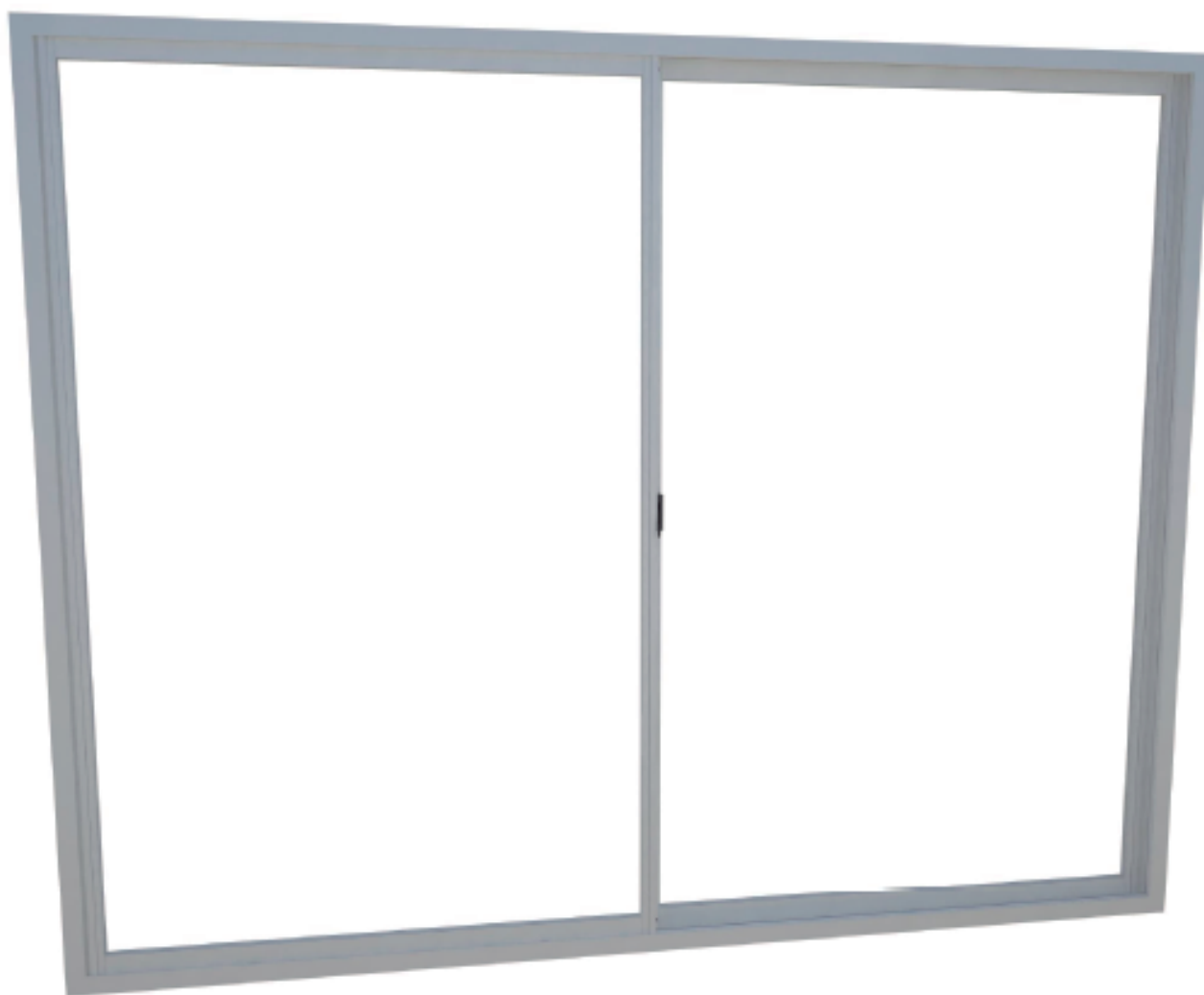

Dimensiones máximas para ventana corrediza

A) 12004

$$J_{xx} = 4.2 \text{ cm}^4$$



B) 99054

$$J_{xx} = 7.6 \text{ cm}^4$$



Presión de viento: 60 Kg/m²

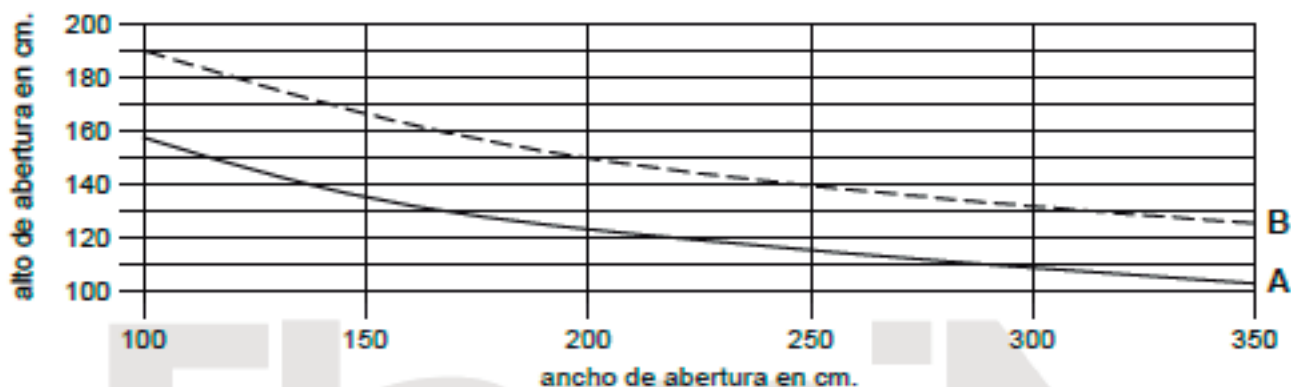

Presión de viento: 80 Kg/m²

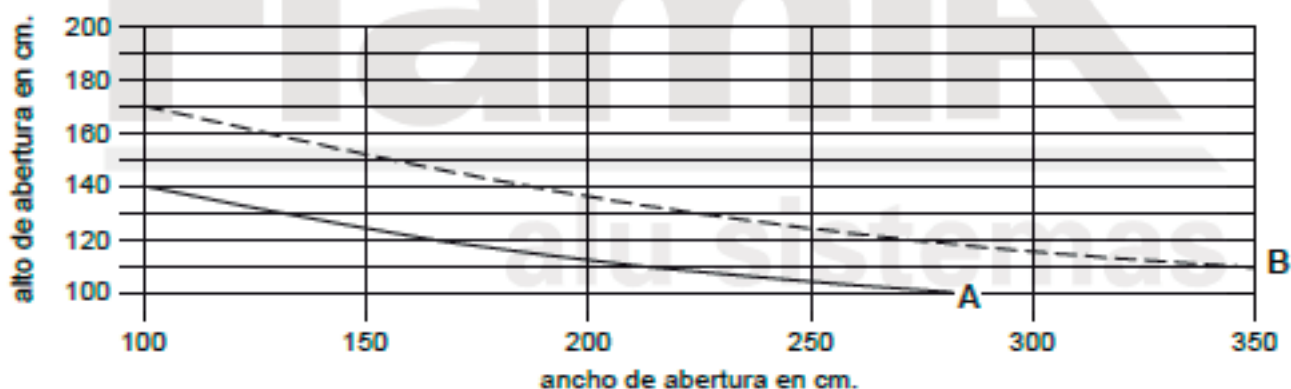

Presión de viento: 100 Kg/m²

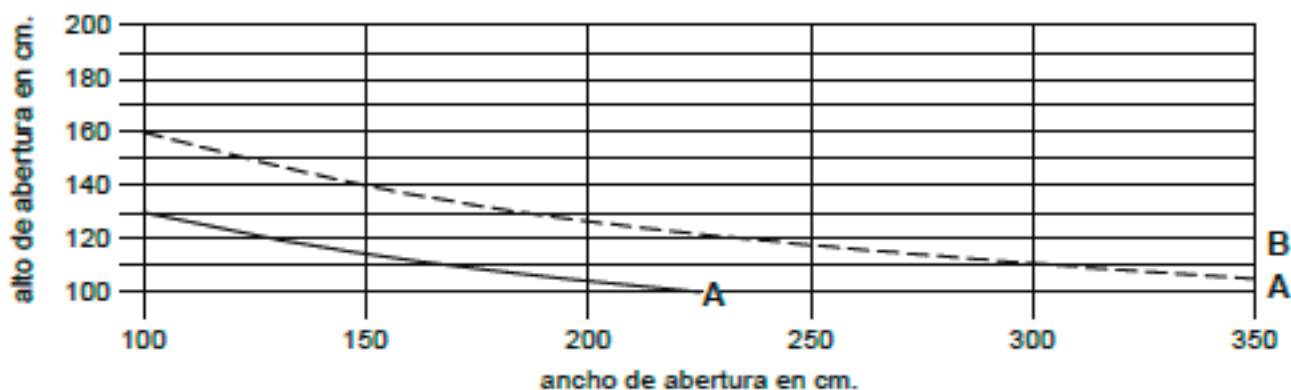

Los tamaños de hoja por debajo de la curva para cada caso cubren las necesidades estáticas.

Además de verificar las dimensiones máximas para cada abertura, es necesario calcular el peso de la hoja según el vidrio seleccionado, para saber la limitación del rodamiento a usar.

Estos cálculos están realizados en forma teórica (no sustituyen a los cálculos estructurales para cada obra), basándose en la norma IRAM 11507-1, utilizando vidrio simple y una deflexión máxima de L/200 con un máximo de 15 mm (L = Alto de abertura).