



VM S.A.
ALUMINIO-ACCESORIOS-COMPACTOS

SISTEMAS DE CARPINTERIA

Placard

LISTADO DE PERFILES

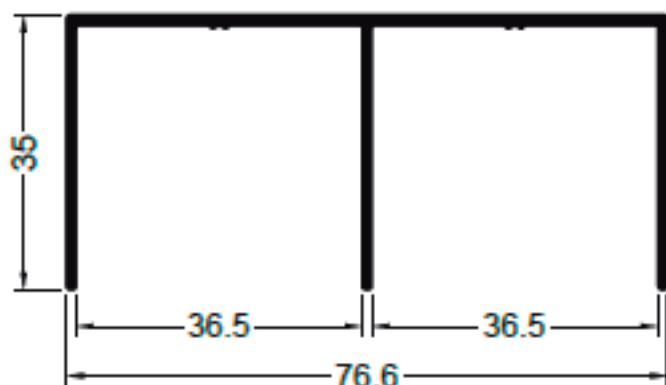

12371
0.609 Kg/m
MARCO DINTEL

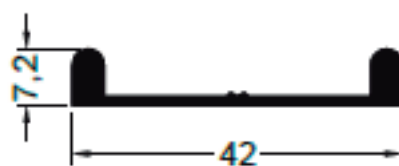

12372
0.256 Kg/m
MARCO UMBRAL

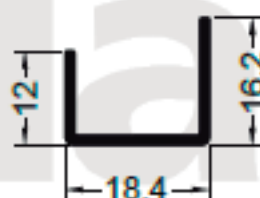

12901
0.186 Kg/m
HOJA UMBRAL
16 mm.

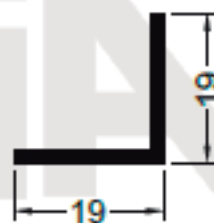

52191
0.147 Kg/m
HOJA UMBRAL
18 mm.

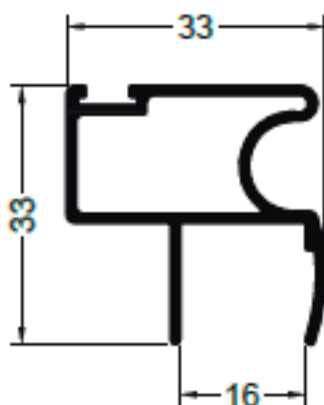

12900
0.459 Kg/m
HOJA JAMBA
16 mm.

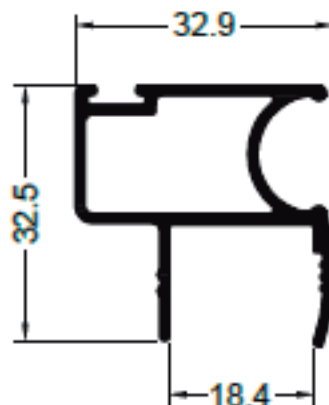

13745
0.477 Kg/m
HOJA JAMBA
18 mm.

Corte horizontal placard 16 mm. 2 y 3 hojas.

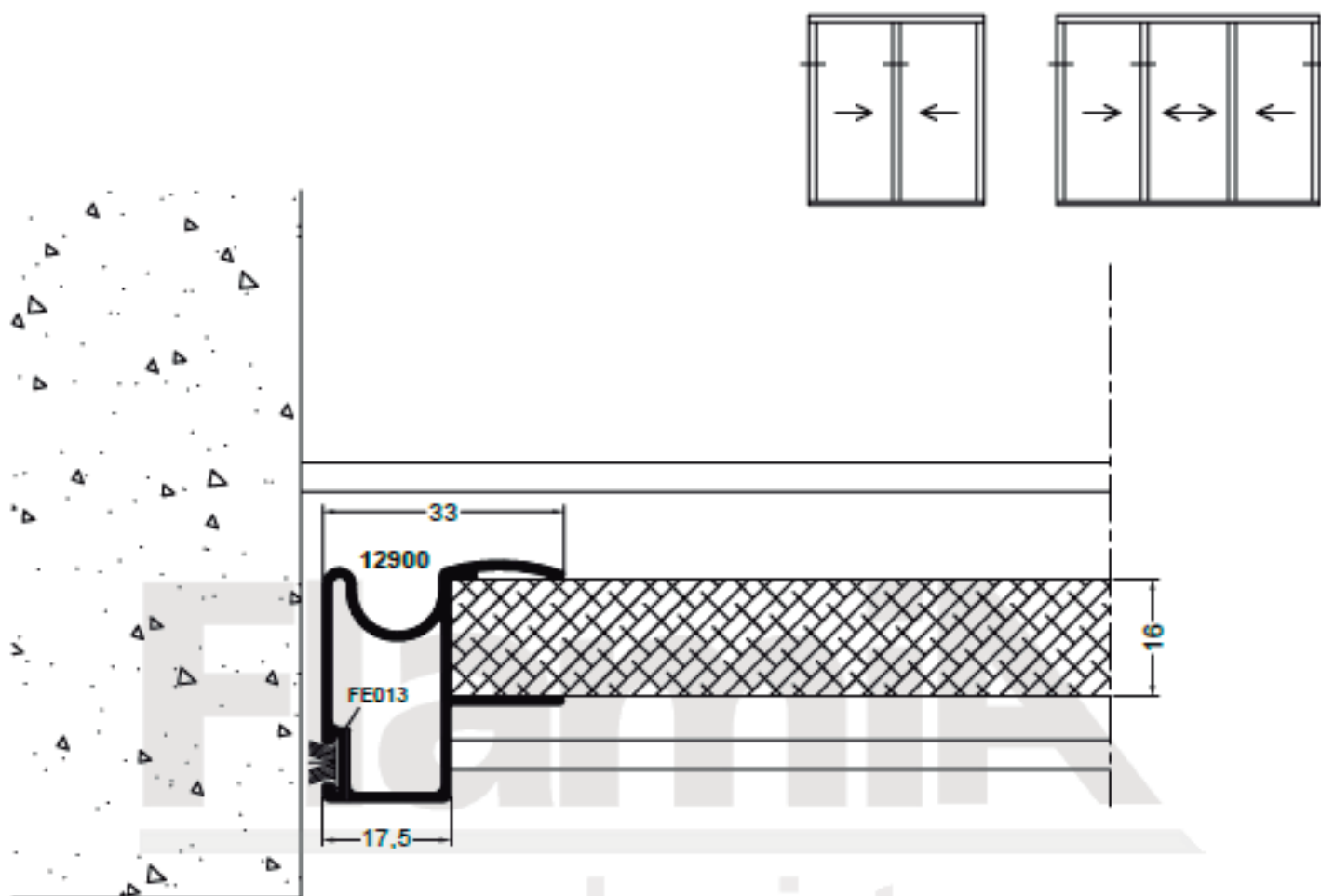

alu sistemas

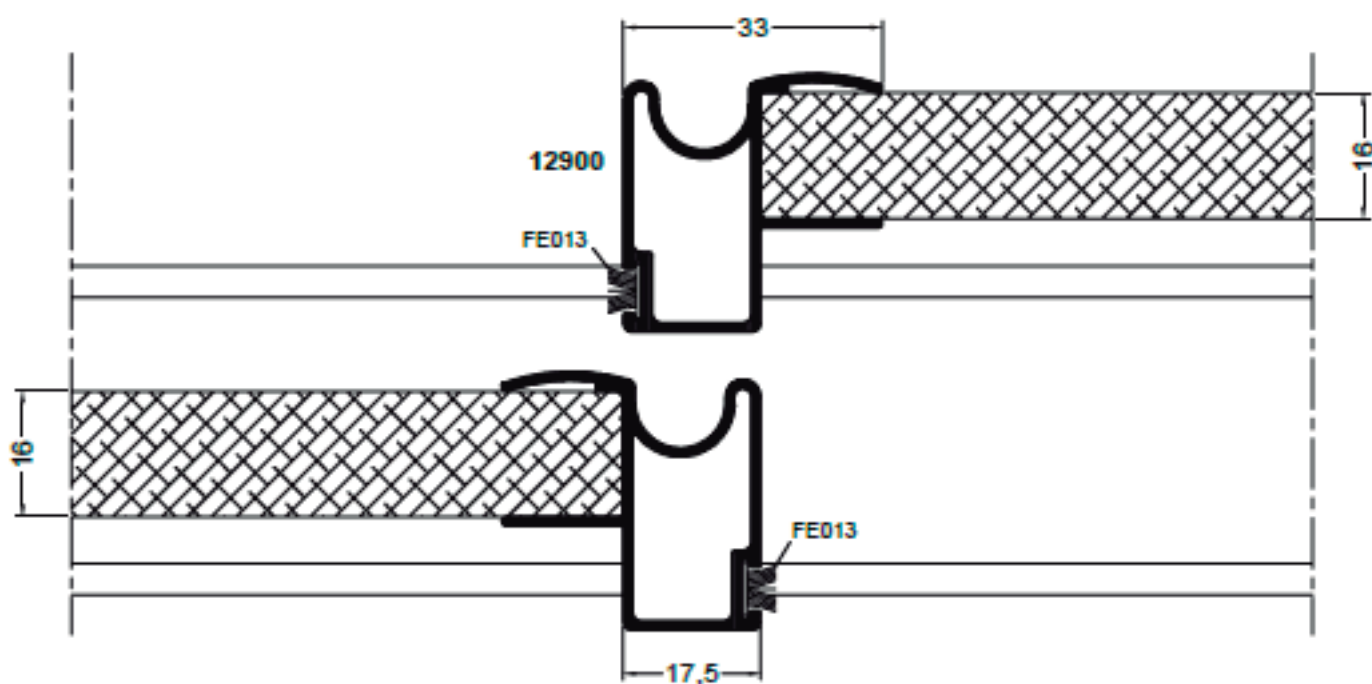

Corte horizontal placard 16 mm. 2 y 3 hojas.

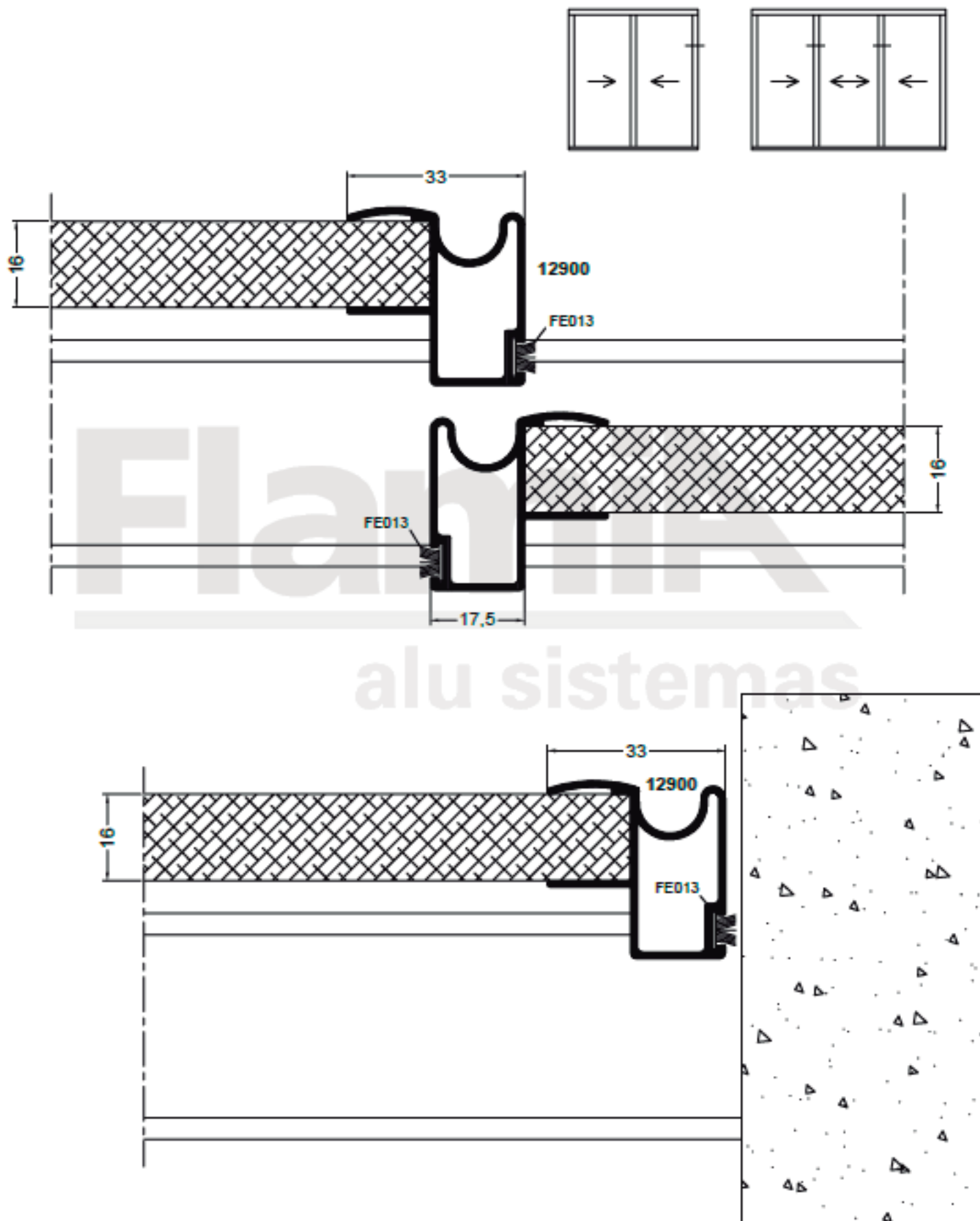

Corte vertical placard 16 mm. 2 y 3 hojas.

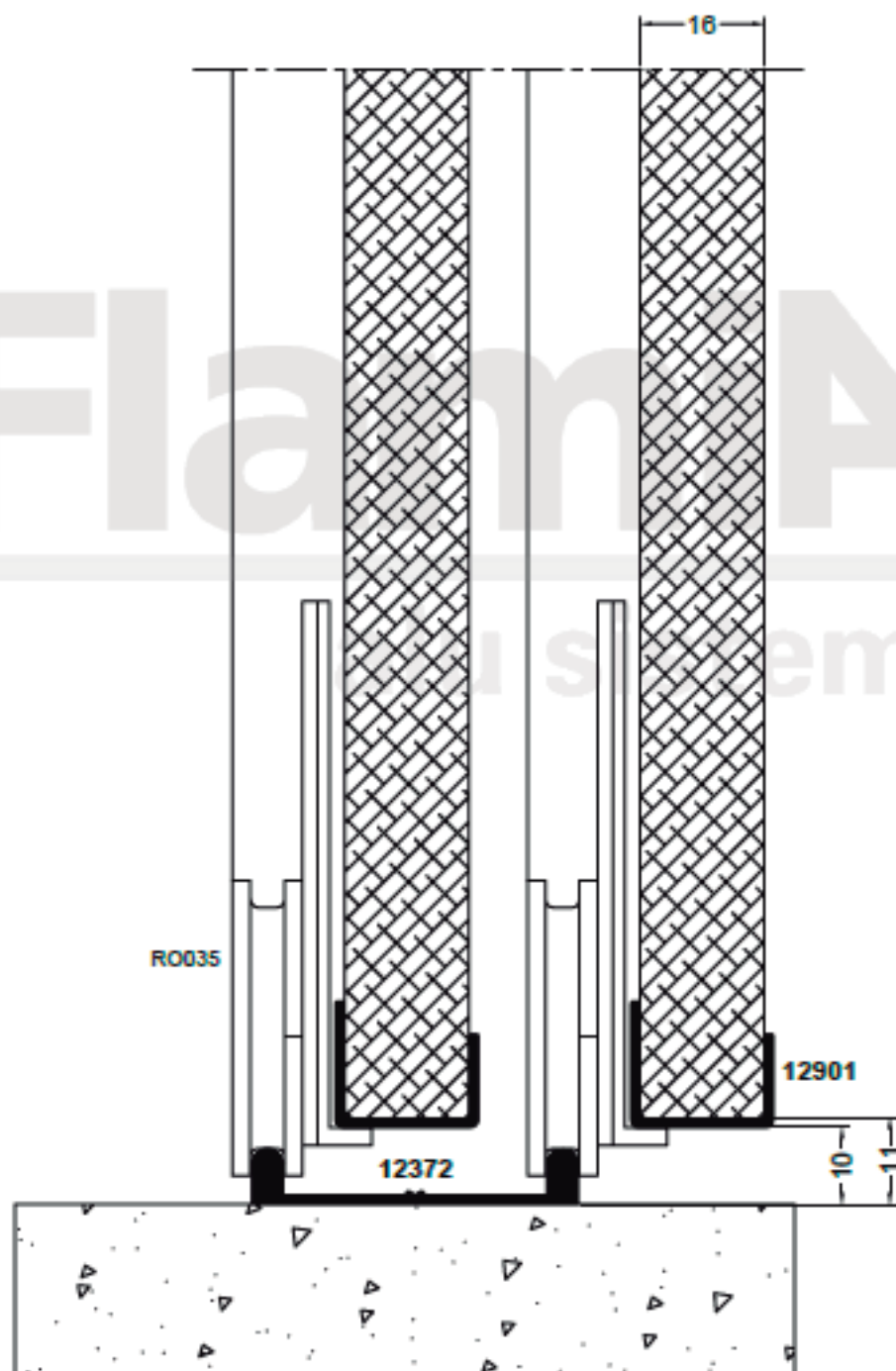
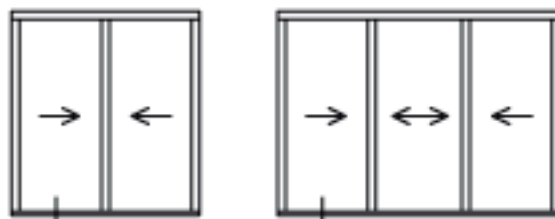

Corte vertical placard 16 mm. 2 y 3 hojas.

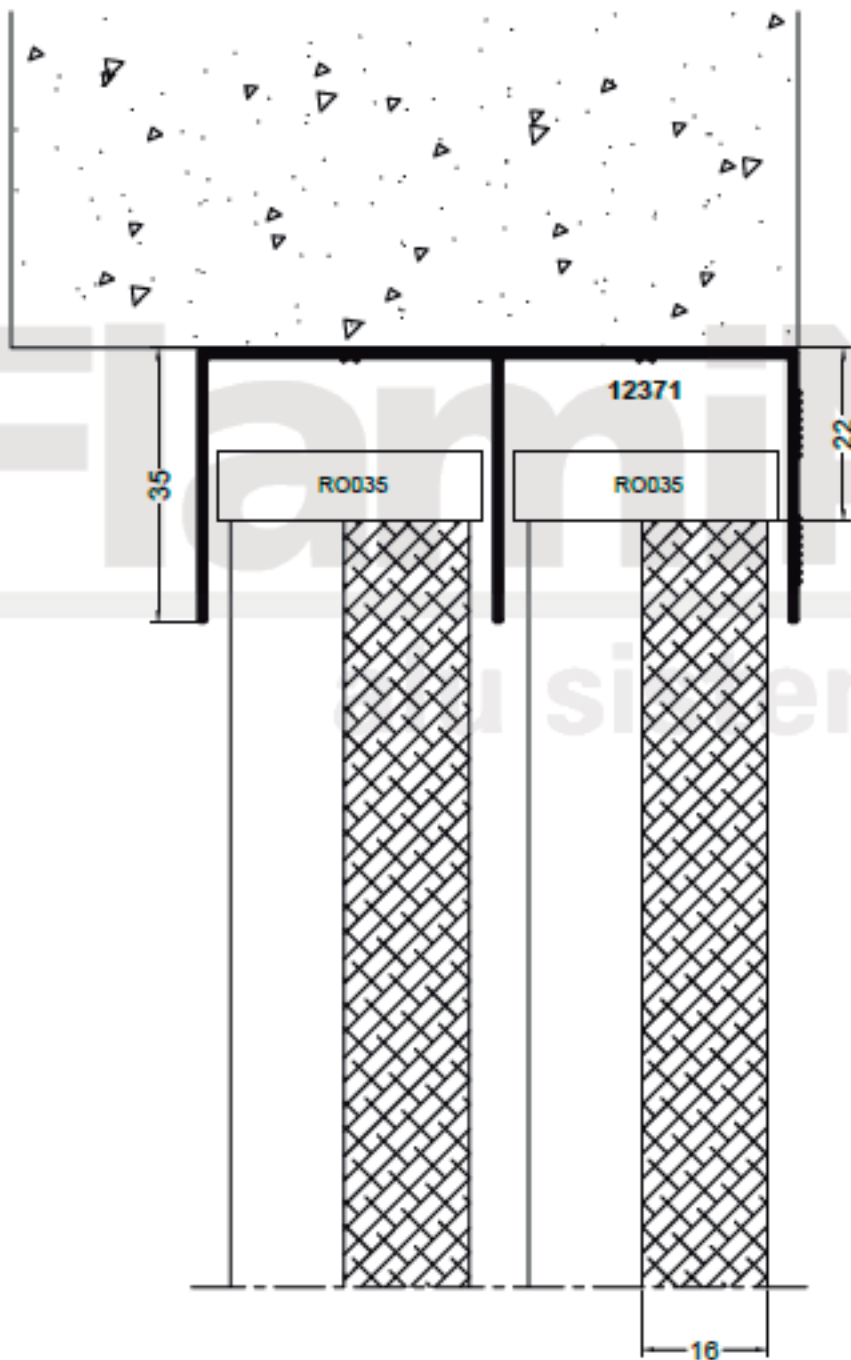
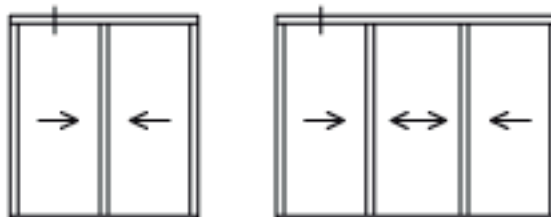

Corte horizontal placard 18 mm. 2 y 3 hojas.

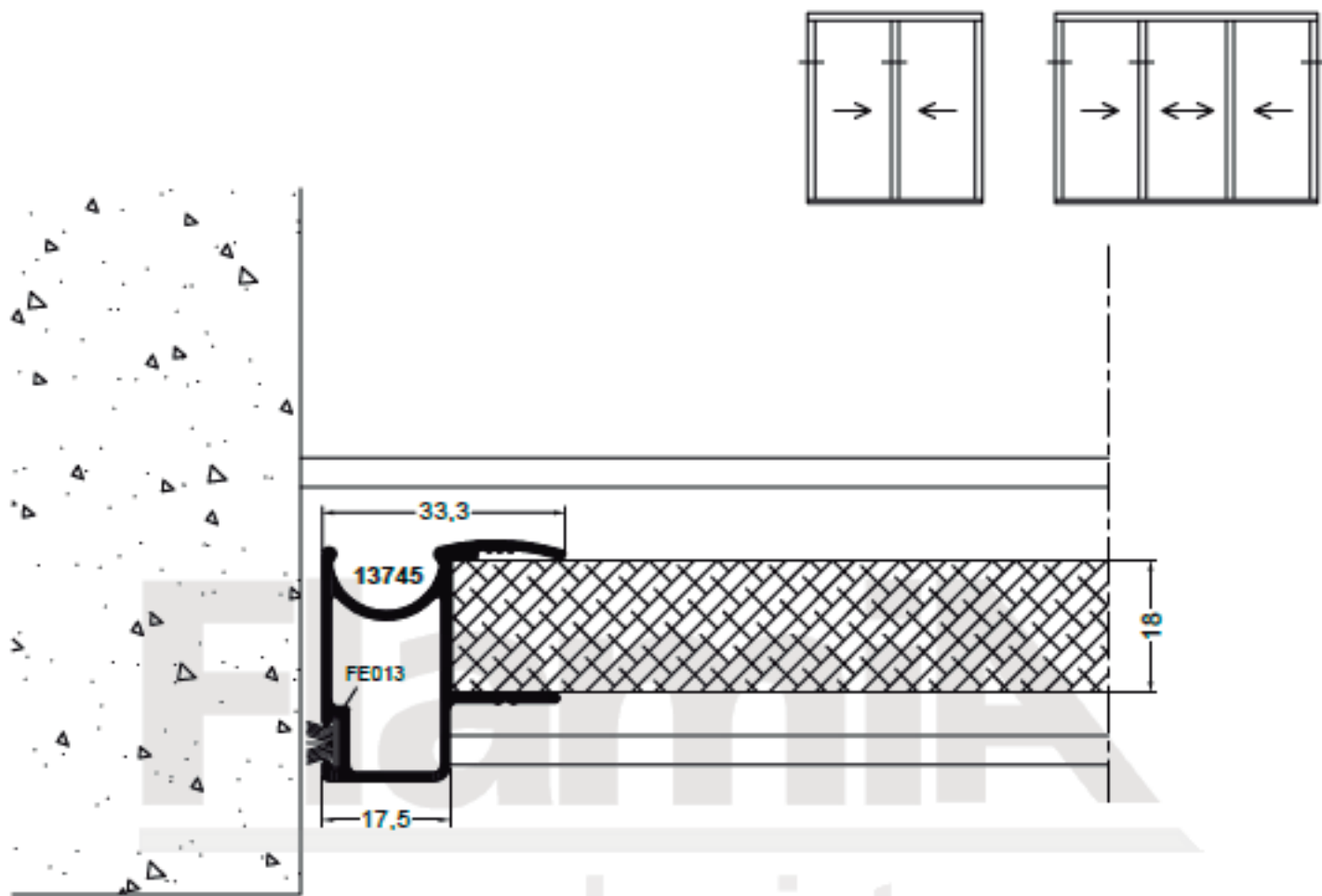

alu sistemas

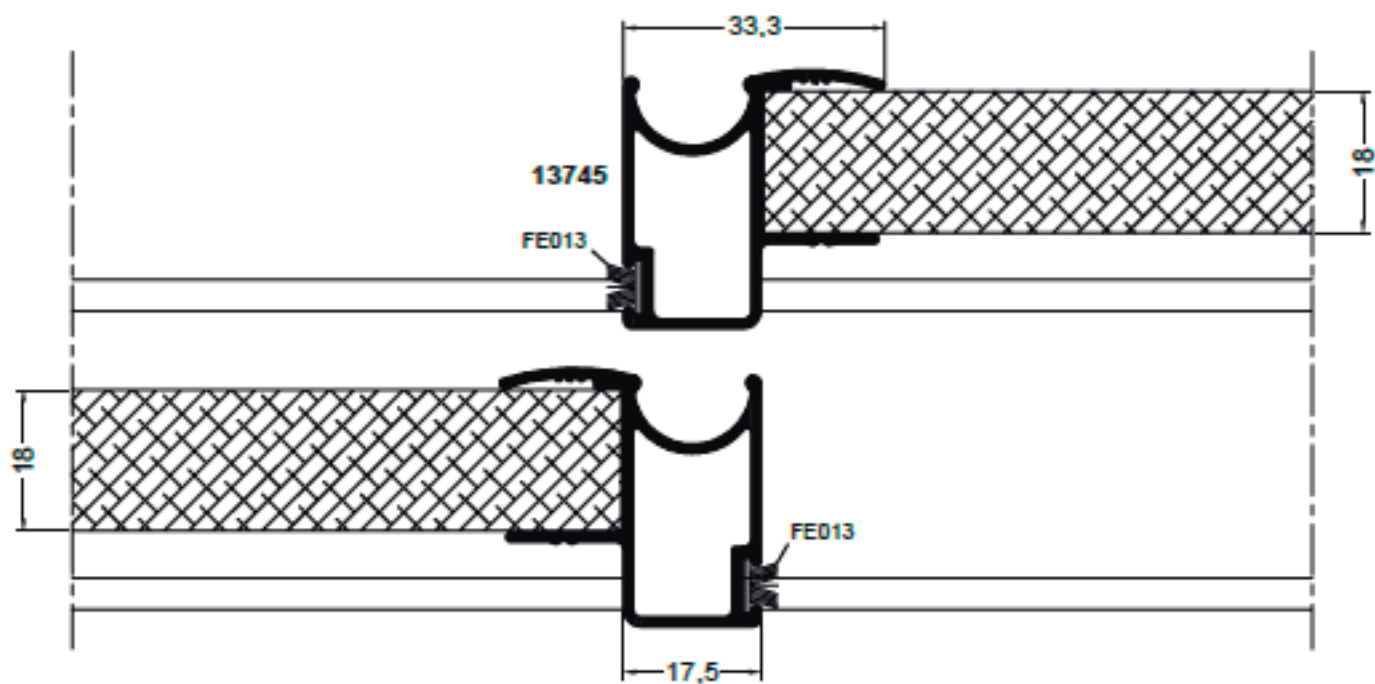

Corte horizontal placard 18 mm. 2 y 3 hojas.

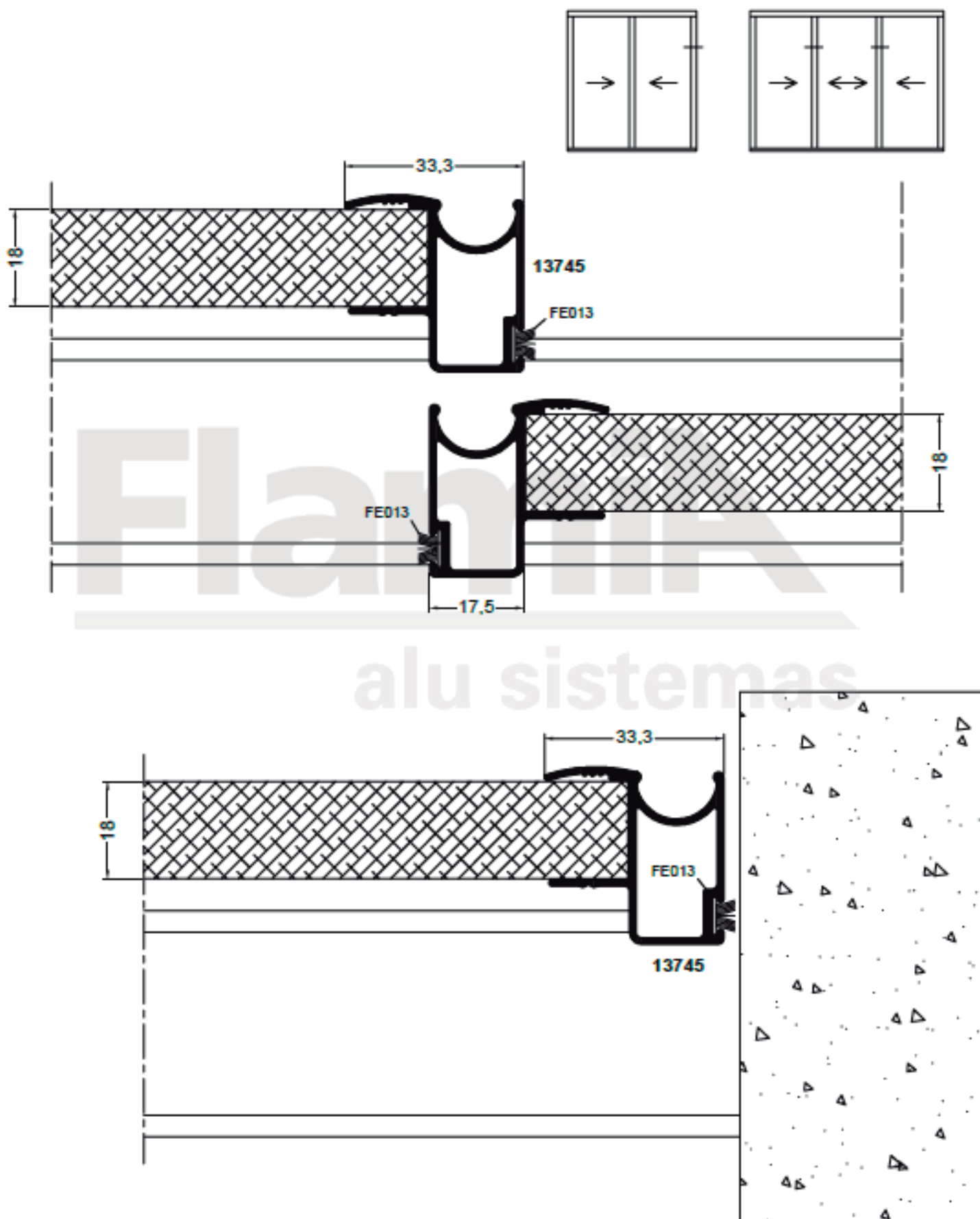

Corte vertical placard 18 mm. 2 y 3 hojas.

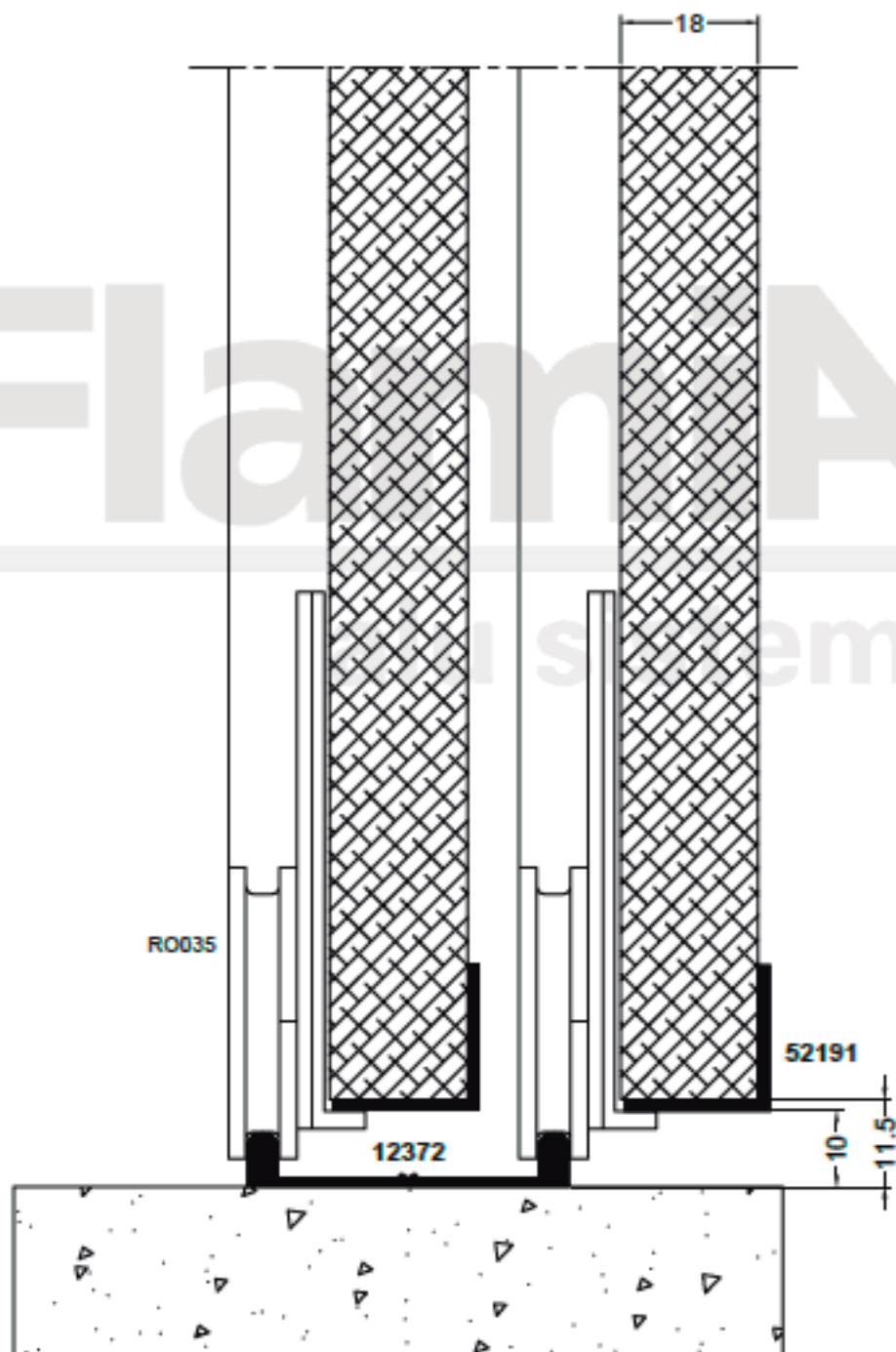
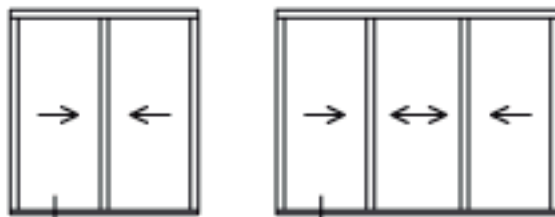



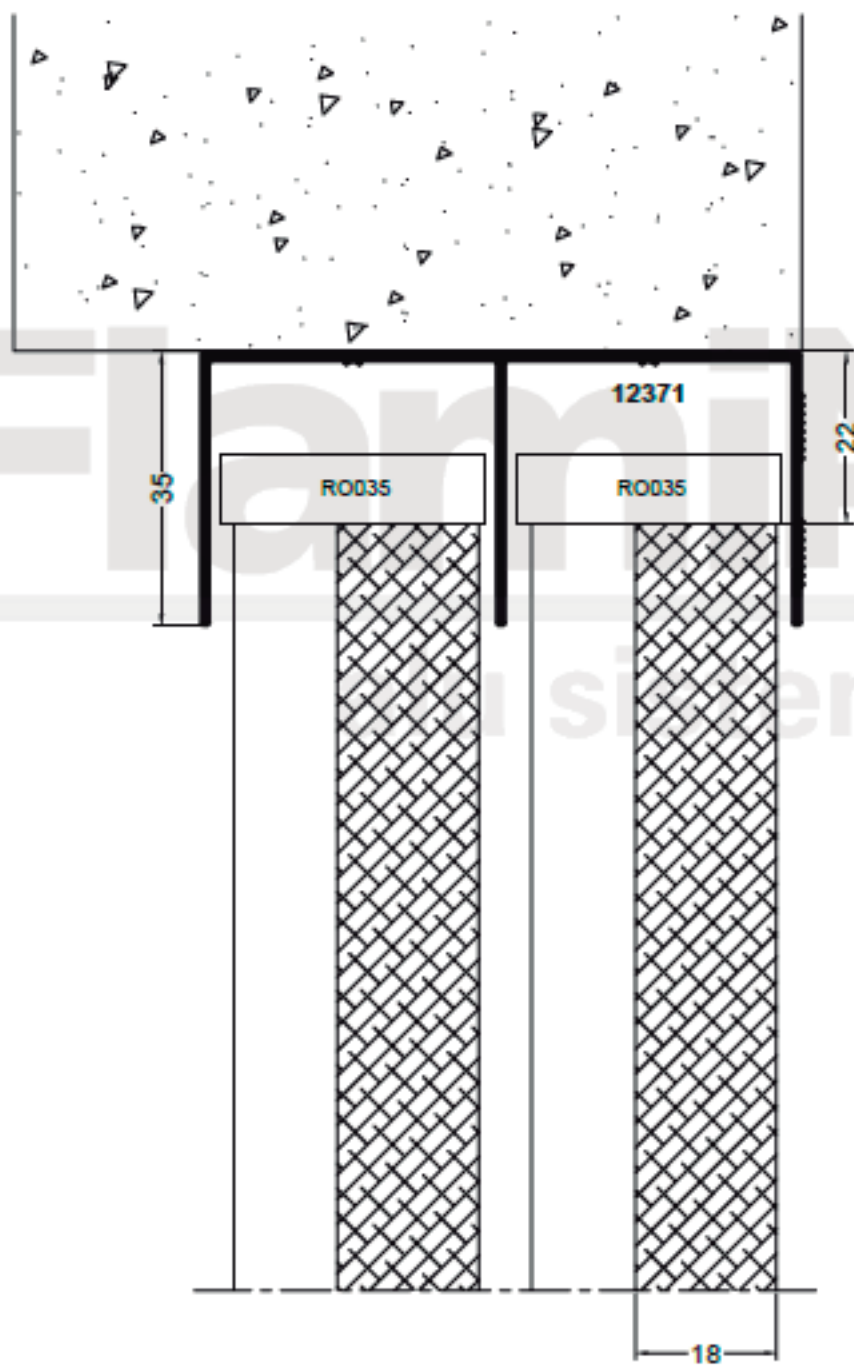
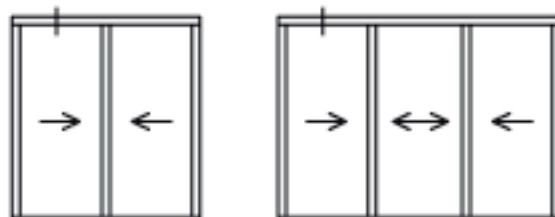



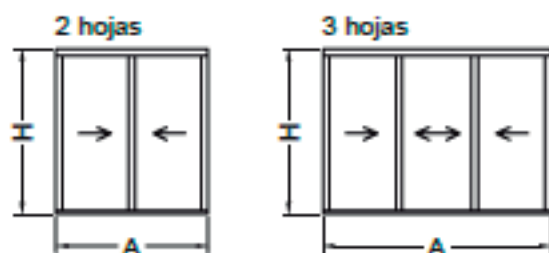





Corte vertical placard 18 mm. 2 y 3 hojas.



Listado de perfiles



Código	Perfil	Descripción	Peso (kg/m)	Corte	2 Hojas				3 Hojas			
					Horizontal		Vertical		Horizontal		Vertical	
					Cant.	Medida	Cant.	Medida	Cant.	Medida	Cant.	Medida
12371		Dintel marco	0.609		1	A			1	A		
12372		Umbral marco	0.256		1	A			1	A		
12901		Umbral hoja 16 mm.	0.142		2	A/2-57			3	A/3-55		
12900		Jamba hoja 16 mm.	0.459				4	H - 32			6	H - 32
52191		Umbral hoja 18 mm.	0.147		2	A/2-57			3	A/3-55	0	
13745		Jamba hoja 18 mm.	0.477				4	H - 32			6	H - 32

Listado de accesorios

Código	Descripción	Cantidad		
		2 hojas	3 hojas	
FE013	Felpa 7x9	Alto	4	6
RO035	Kit rodamiento (rueda + patín superior + freno)		2	3